

40V 1.2mohm N-channel SGT MOSFET AKG4N013GM-A

Description:

This device is designed for automotive applications and manufactured in IATF16949 certified facilities. Qualified AEC-Q101, PPAP capable.

Features:

- Low $R_{DS(ON)}$
- 100% UIS Tested
- RoHS compliant ^(Note 1)
- Halogen-free ^(Note 1)
- AEC-Q101 qualified and PPAP capable

Applications:

- Battery Management System
- Motor Drivers
- DC-DC Converter

Key Performance Parameters:

Parameter	Value	Unit
V_{DS}	40	V
$R_{DS(ON), max} @ V_{GS} = 10V$	1.2	m Ω
I_D	235	A

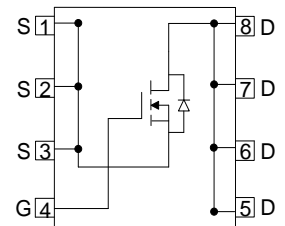
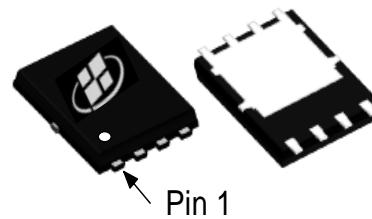

Ordering Information:

Ordering Code	Package Type	Marking Code	Form	Packing
AKG4N013GM-A	DFN5X6	G4N013GM	Tape Reel	5000PCS

Notes:

1. Contact ALKAIDSEMI sales for detail information

Maximum Ratings ($T_A = 25^\circ\text{C}$ unless otherwise noted)

Symbol	Parameter	Value	Units
V_{DS}	Drain-Source Voltage	40	V
I_D	Drain Current - Continuous ($T_C = 25^\circ\text{C}$) ^(Note 1)	235	A
	Drain Current - Continuous ($T_C = 100^\circ\text{C}$)	165	A
I_{DM}	Drain Current - Pulsed ^(Note 2)	900	A
V_{GS}	Gate-Source Voltage	± 20	V
E_{AS}	Single Pulsed Avalanche Energy ^(Note 3)	625	mJ
P_D	Power Dissipation ($T_C = 25^\circ\text{C}$)	125	W
T_J, T_{STG}	Operating and Storage Temperature Range	-55 to +175	$^\circ\text{C}$

Thermal Characteristics

Symbol	Parameter	Value	Units
$R_{\theta JC}$	Thermal Resistance, Junction-to-Case, Steady-State	1.2	$^\circ\text{C/W}$
$R_{\theta JA}$	Thermal Resistance, Junction-to-Ambient, Steady State ^(Note 4)	45	$^\circ\text{C/W}$

Notes:

1. The max drain current rating is package limited
2. Repetitive Rating: Pulse width limited by maximum junction temperature
3. $L = 0.5 \text{ mH}$, $V_{DD} = 40 \text{ V}$, $I_{AS} = 50 \text{ A}$, $R_G = 25 \Omega$, Starting $T_J = 25 \text{ }^\circ\text{C}$
4. Mount on minimum PCB layout

Electrical Characteristics ($T_J = 25^\circ\text{C}$ unless otherwise noted)						
Symbol	Parameter	Test Conditions	Min	Typ	Max	Units
Static Characteristics						
BV_{DSS}	Drain-Source Breakdown Voltage	$V_{GS} = 0\text{ V}, I_D = 250\ \mu\text{A}$	40			V
I_{DSS}	Zero Gate Voltage Drain Current	$V_{DS} = 40\text{ V}, V_{GS} = 0\text{ V},$			1	μA
		$V_{DS} = 40\text{ V}, V_{GS} = 0\text{ V}, T_J = 125^\circ\text{C}$			100	μA
I_{GSS}	Gate Leakage Current	$V_{GS} = \pm 20\text{ V}, V_{DS} = 0\text{ V}$			± 100	nA
$V_{GS(TH)}$	Gate Threshold voltage	$V_{DS} = V_{GS}, I_D = 250\ \mu\text{A}$	2.5	3	3.5	V
$R_{DS(ON)}$	Drain-Source on-state resistance	$V_{GS} = 10\text{ V}, I_D = 50\text{ A}$		0.9	1.2	m Ω
Dynamic Characteristics						
C_{ISS}	Input Capacitance	$V_{DS} = 25\text{ V}, V_{GS} = 0\text{ V},$ $F = 1\text{ MHz}$		5810		pF
C_{OSS}	Output Capacitance			1640		pF
C_{RSS}	Reverse Transfer Capacitance			15		pF
Switching Characteristics						
$T_{D(ON)}$	Turn On Delay Time	$V_{DD} = 20\text{ V}, R_L = 0.4\ \Omega,$ $V_{GS} = 10\text{ V}, R_G = 2.5\ \Omega$		15		nS
T_R	Rise Time			50		nS
$T_{D(OFF)}$	Turn Off Delay Time			65		nS
T_F	Fall Time			45		nS
Q_G	Total Gate Charge	$V_{DD} = 20\text{ V}, I_D = 50\text{ A},$ $V_{GS} = 10\text{ V}$		72		nC
Q_{GS}	Gate-Source Charge			30		nC
Q_{GD}	Gate-Drain Charge			14		nC
Drain-Source Diode Characteristics and Maximum Ratings						
I_S	Maximum Continuous Body-Diode Forward Current			235		A
I_{SM}	Maximum Pulsed Body-Diode Forward Current ^(NOTE 1)			900		A
V_{SD}	Diode Forward Voltage	$V_{GS} = 0\text{ V}, I_S = 50\text{ A}$		0.8	1.2	V
T_{RR}	Reverse recovery time	$V_{DD} = 20\text{ V}, I_D = 50\text{ A},$ $di/dt = 100\text{ A}/\mu\text{S}$		75		nS
Q_{RR}	Reverse recovery charge			150		nC
I_{RRM}	Peak Reverse Recovery Current			3		A

Electrical Characteristics Diagrams

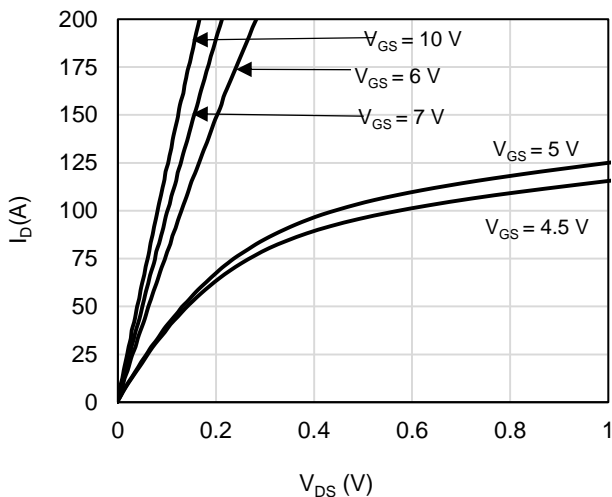

Figure 1: On-Region Characteristics

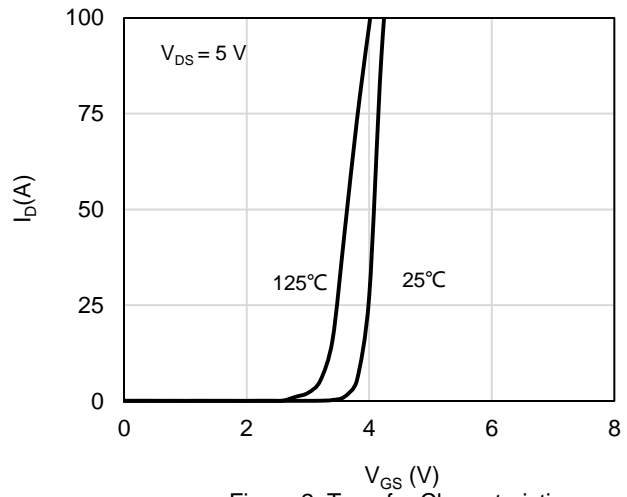

Figure 2: Transfer Characteristics

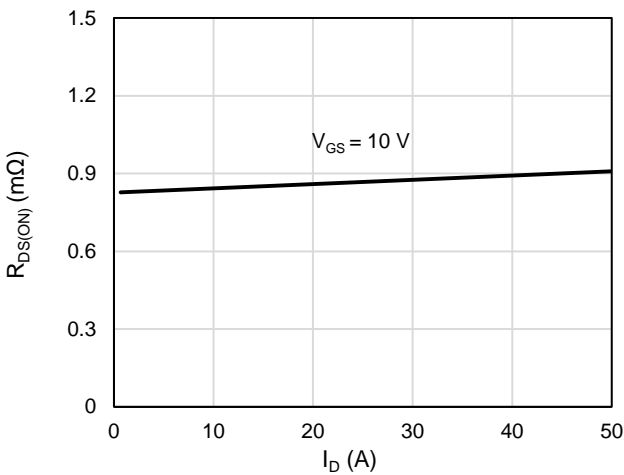

Figure 3: On-Resistance vs. Drain Current and Gate Voltage

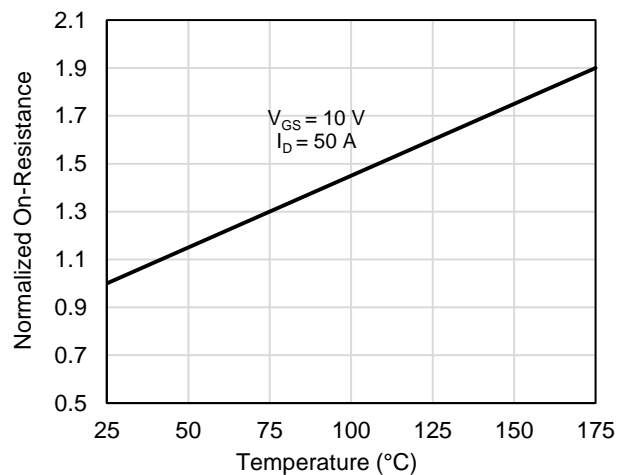

Figure 4: On-Resistance vs. Junction Temperature

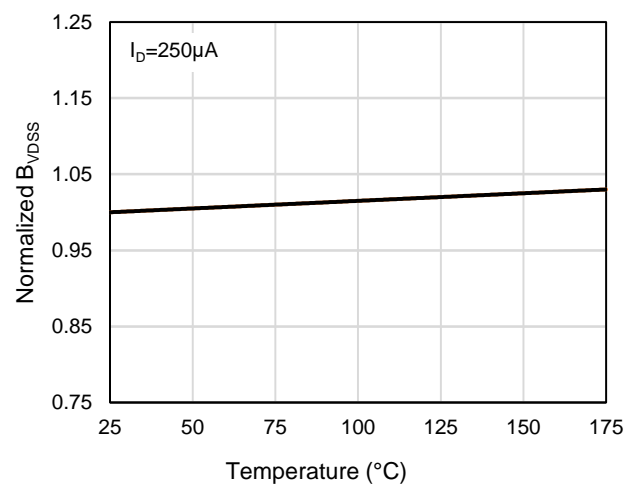

Figure 5: Breakdown Voltage vs. Junction Temperature

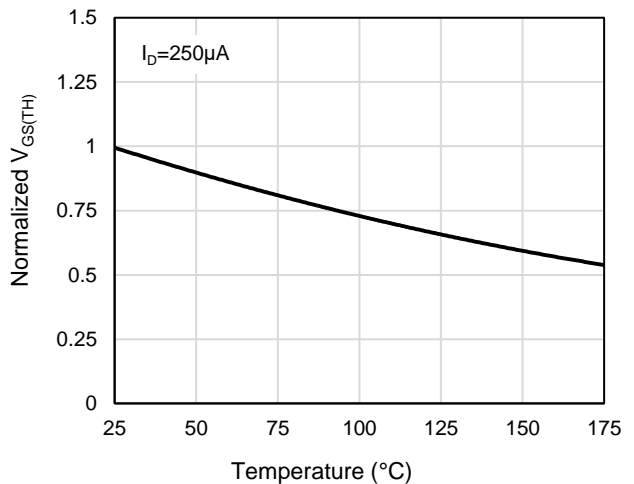
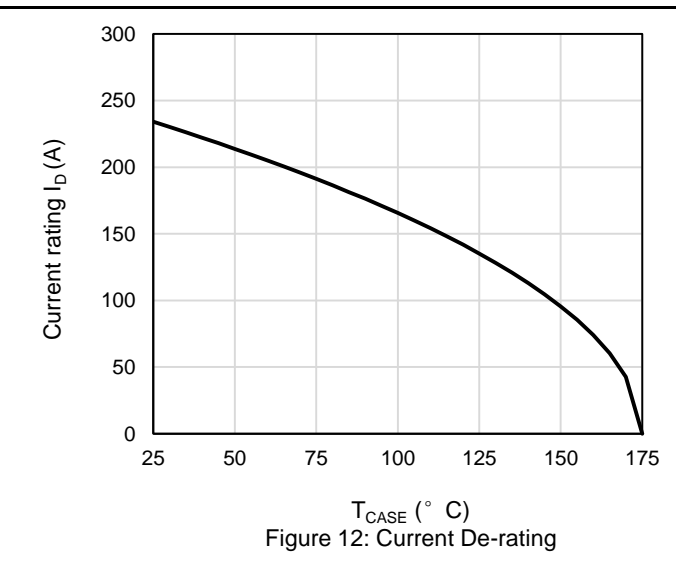
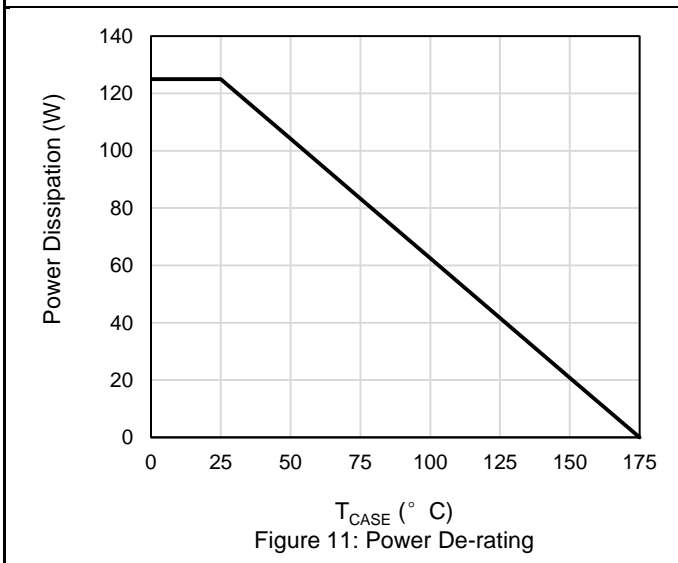
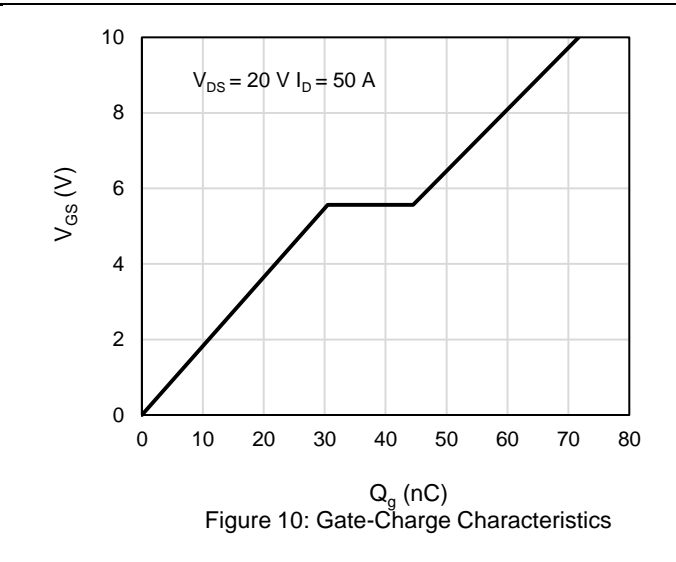
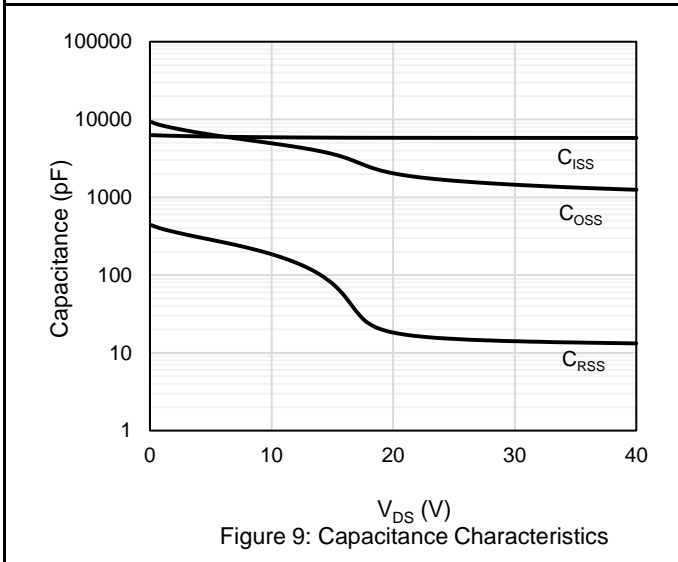
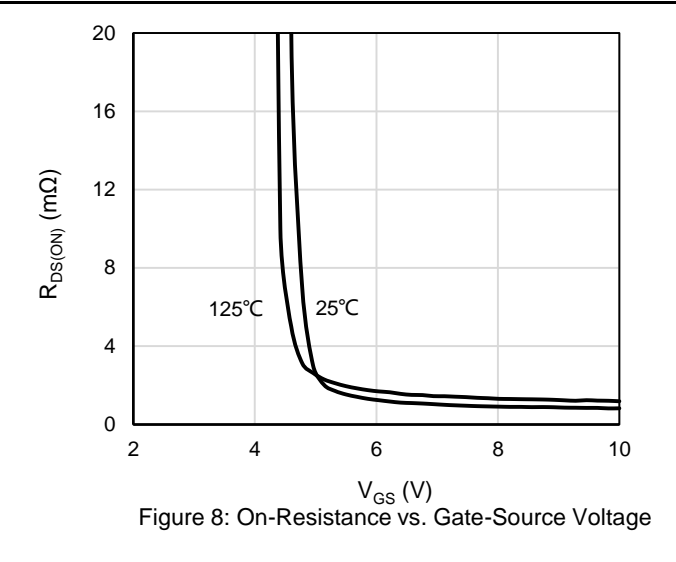
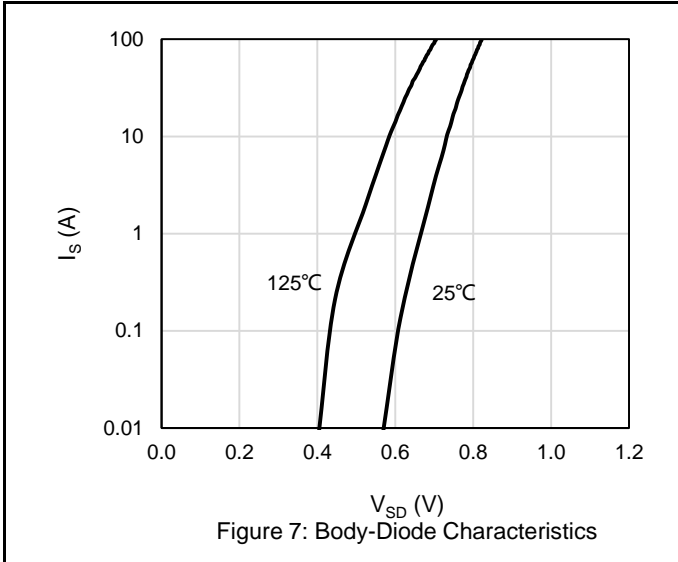
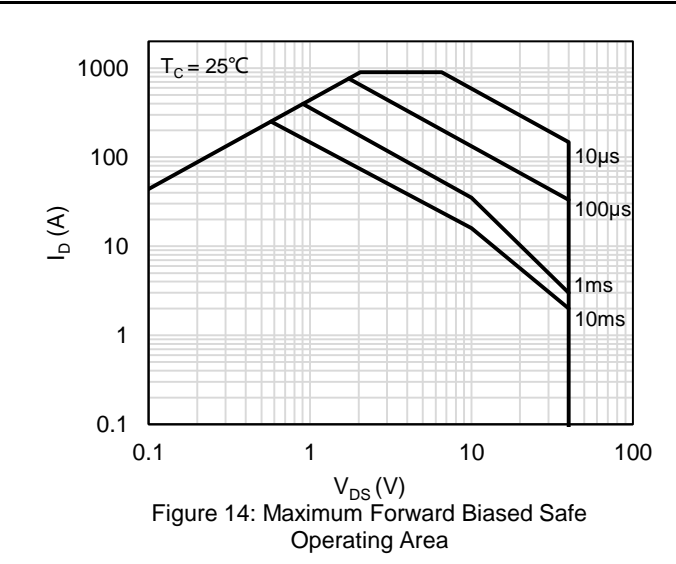
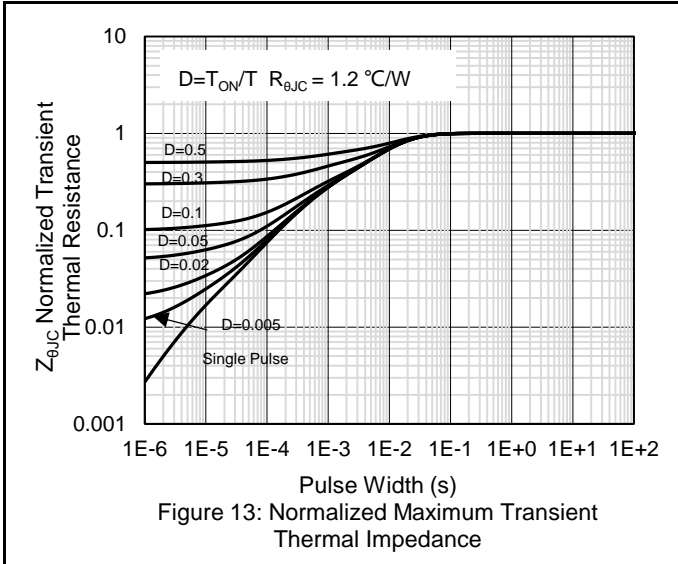

Figure 6: Threshold Voltage vs. Junction Temperature





Test Circuit and Waveform

Gate Charge Test Circuit & Waveform

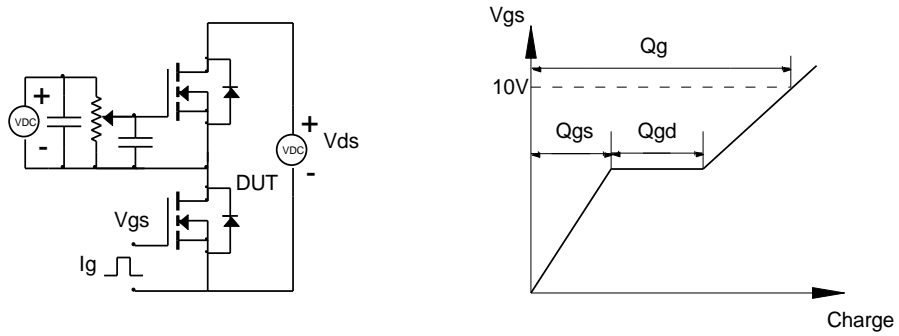

Resistive Switching Test Circuit & Waveforms

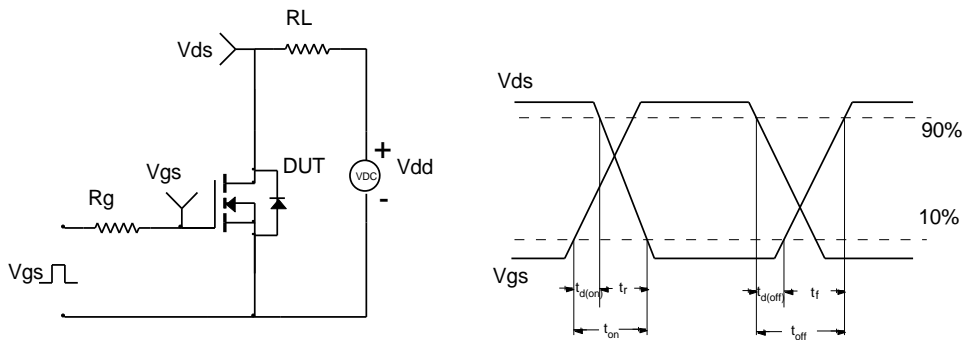

Unclamped Inductive Switching (UIS) Test Circuit & Waveforms

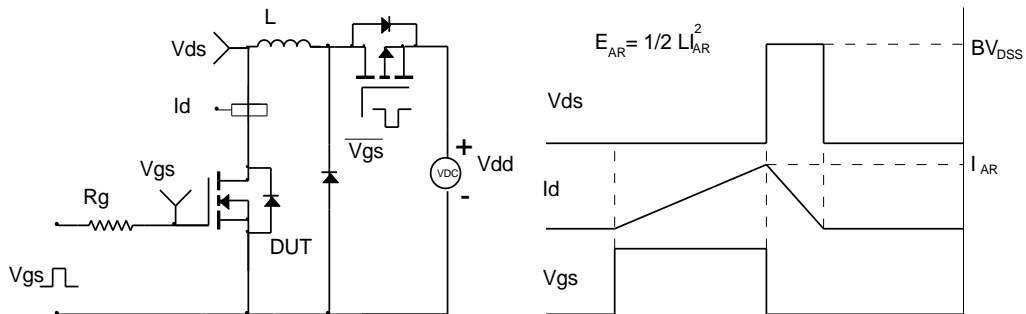

Diode Recovery Test Circuit & Waveforms

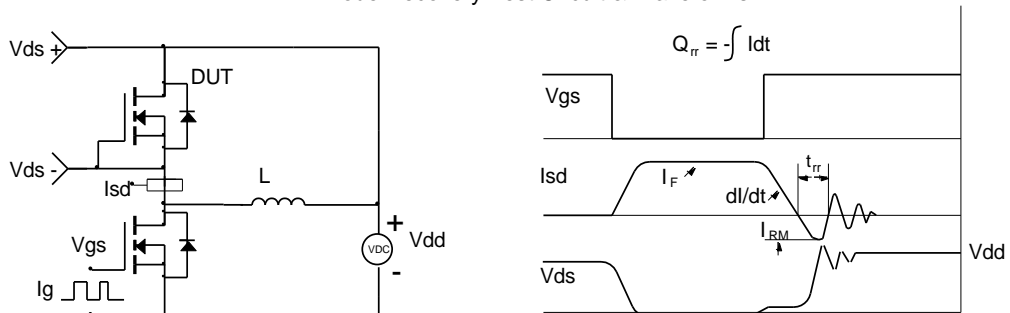

Package Outlines

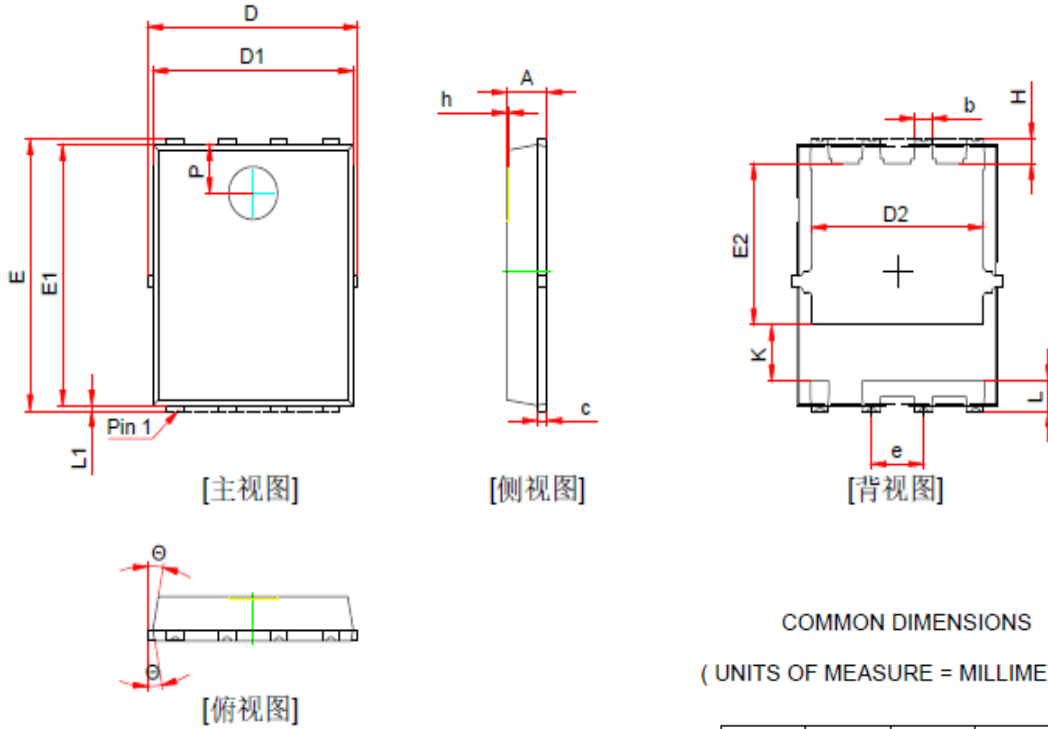

COMMON DIMENSIONS
(UNITS OF MEASURE = MILLIMETER)

SYMBOL	MIN	NOM	MAX
A	0.90	1.00	1.10
b	0.32	0.42	0.52
c	0.21	0.25	0.34
D	5.00	5.15	5.30
D1	4.80	4.90	5.00
D2	4.10	4.20	4.30
e	1.27BSC		
E	6.00	6.15	6.30
E1	5.80	5.90	6.00
E2	3.55	3.65	3.75
H	0.45	0.55	0.65
h	-	-	0.10
K	1.22	-	-
L	0.535	0.635	0.735
L1	0.05	0.13	0.21
θ	8°	10°	12°
P	1.05	1.10	1.15

Marking Information



Note:
 G4N013GM = Product Name Code
 XXXXXXXX = Date code
 Contact ALKAIDSEMI sales for detail information

REEL DIMENSIONS

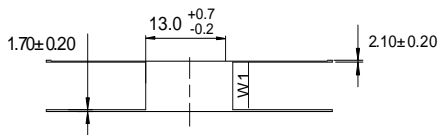
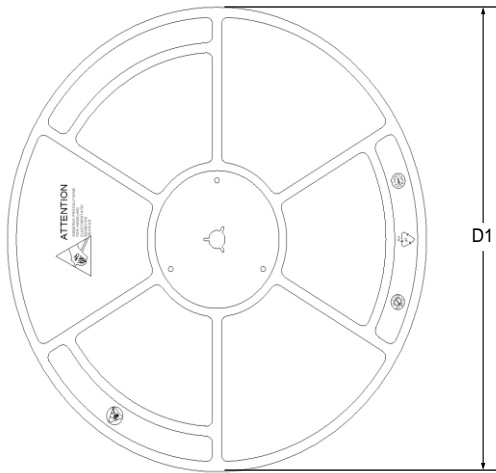

TAPE DIMENSIONS

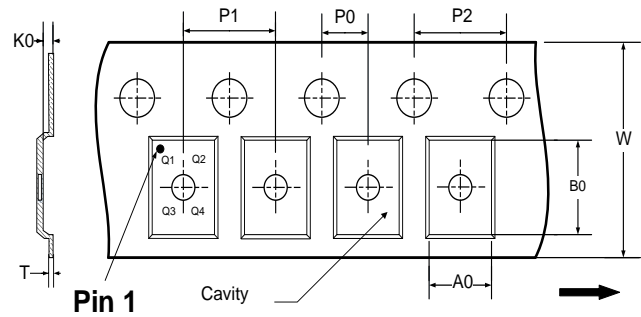

- A0: Dimension designed to accommodate the component width
- B0: Dimension designed to accommodate the component length
- K0: Dimension designed to accommodate the component thickness
- W: Overall width of the carrier tape
- P0: Pitch between successive cavity centers and sprocket hole
- P1: Pitch between successive cavity centers
- P2: Pitch between sprocket hole
- T: Tape material thickness
- D1: Reel Diameter
- W1: Reel Width

DIMENSIONS										(Unit: mm)
Reel	D1	W1								Material
	330	12.5								Hips
Tape	P0	P1	P2	W	A0	B0	K0	T	Pin 1 Quadrant	Material
	4	8	2	12	6.3	5.3	1.2	0.25	Q1	PC
All dimensions are nominal										

Revision History

Revision	Release Date	Remark
Rev.1.0	2022/9/22	Initial Release

Disclaimer

The information given in this document describes the independent performance of the product, but similar performance is not guaranteed under other working conditions, and cannot be guaranteed when installed with other products or equipment. To achieve the required performance of the product in actual scenarios, the customer should conduct a complete application test to assess the functionality of the product.

Alkaidsemi assumes no responsibility for equipment failures result from using products at values that exceed the ratings, operating conditions, or other parameters listed in the product specifications.

The product described in this specification is not applicable for aerospace or other applications which requires high reliability. Customers using or selling these products for use in medical, life-saving, or life-sustaining applications do so at their own risk and agree to fully indemnify.

Due to product or technical improvements, the information described or contained herein may be changed without prior notice.