

40V 2.4mohm N-channel SGT MOSFET AKG4N024PM

Description:

This N channel SGT MOSFET has been designed to low on-state resistance, low switching loss with good E_{AS} performance, especially for DC-DC and Motor driving applications.

Features:

- Low FOM $R_{DS(ON)} \times Q_G$
- Ultra-low on-resistance
- RoHS compliant ^(Note 1)
- Halogen-free ^(Note 1)
- 100% UIS Tested

Applications:

- Battery Management System
- Motor Drivers
- DC-DC Converter

Key Performance Parameters:

Parameter	Value	Unit
V_{DS}	40	V
$R_{DS(ON), max} @ V_{GS} = 10V$	2.4	m Ω
I_D	120	A

TO-220

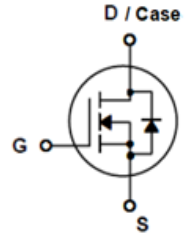
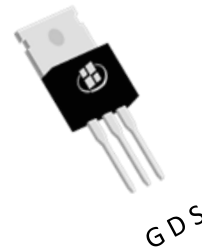

Ordering Information:

Ordering Code	Package Type	Marking Code	Form	Packing
AKG4N024PM	TO-220	G4N024PM	Tube	1000PCS

Notes:

1. Contact ALKAIDSEMI sales for detail information

Maximum Ratings ($T_A = 25^\circ\text{C}$ unless otherwise noted)

Symbol	Parameter	Value	Units
V_{DS}	Drain-Source Voltage	40	V
I_D	Drain Current - Continuous ($T_C = 25^\circ\text{C}$) ^(Note 1)	120	A
	Drain Current - Continuous ($T_C = 100^\circ\text{C}$)	120	A
I_{DM}	Drain Current - Pulsed ^(Note 2)	440	A
V_{GS}	Gate-Source Voltage	± 20	V
E_{AS}	Single Pulsed Avalanche Energy ^(Note 3)	361	mJ
P_D	Power Dissipation ($T_C = 25^\circ\text{C}$)	192	W
T_J, T_{STG}	Operating and Storage Temperature Range	-55 to +150	$^\circ\text{C}$

Thermal Characteristics

Symbol	Parameter	Value	Units
$R_{\theta JC}$	Thermal Resistance, Junction-to-Case, Steady-State	0.7	$^\circ\text{C}/\text{W}$
$R_{\theta JA}$	Thermal Resistance, Junction-to-Ambient, Steady State ^(Note 4)	50	$^\circ\text{C}/\text{W}$

Notes:

1. The max drain current rating is package limited
2. Repetitive Rating: Pulse width limited by maximum junction temperature
3. $L = 0.5 \text{ mH}$, $V_{DD} = 20\text{V}$, $I_{AS} = 38 \text{ A}$, $R_G = 25 \Omega$, Starting $T_J = 25 \text{ }^\circ\text{C}$
4. Mount on minimum PCB layout

Electrical Characteristics ($T_J = 25^\circ\text{C}$ unless otherwise noted)						
Symbol	Parameter	Test Conditions	Min	Typ	Max	Units
Static Characteristics						
BV_{DSS}	Drain-Source Breakdown Voltage	$V_{GS} = 0\text{ V}, I_D = 250\ \mu\text{A}$	40			V
I_{DSS}	Zero Gate Voltage Drain Current	$V_{DS} = 40\text{ V}, V_{GS} = 0\text{ V}$			1	μA
I_{GSS}	Gate Leakage Current	$V_{GS} = \pm 20\text{ V}, V_{DS} = 0\text{ V}$			± 100	nA
$V_{GS(TH)}$	Gate Threshold voltage	$V_{DS} = V_{GS}, I_D = 250\ \mu\text{A}$	2	3.2	4	V
$R_{DS(ON)}$	Drain-Source on-state resistance	$V_{GS} = 10\text{ V}, I_D = 20\text{ A}$		2	2.4	m Ω
Dynamic Characteristics						
C_{ISS}	Input Capacitance	$V_{DS} = 20\text{ V}, V_{GS} = 0\text{ V},$ $F = 1\text{ MHz}$		3244		pF
C_{OSS}	Output Capacitance			1077		pF
C_{RSS}	Reverse Transfer Capacitance			52		pF
R_G	Gate Resistance	$F = 1\text{ MHz}$		6		Ω
Switching Characteristics						
$T_{D(ON)}$	Turn On Delay Time	$V_{DD} = 20\text{ V}, R_L = 1\ \Omega,$ $V_{GS} = 10\text{ V}, R_G = 6\ \Omega$		22		nS
T_R	Rise Time			45		nS
$T_{D(OFF)}$	Turn Off Delay Time			68		nS
T_F	Fall Time			25		nS
Q_G	Total Gate Charge	$V_{DD} = 20\text{ V}, I_D = 20\text{ A},$ $V_{GS} = 10\text{ V}$		57		nC
Q_{GS}	Gate-Source Charge			20		nC
Q_{GD}	Gate-Drain Charge			8		nC
Drain-Source Diode Characteristics and Maximum Ratings						
I_S	Maximum Continuous Body-Diode Forward Current			0		A
I_{SM}	Maximum Pulsed Body-Diode Forward Current ^(NOTE 1)			0		A
V_{SD}	Diode Forward Voltage	$V_{GS} = 0\text{ V}, I_S = 1\text{ A}$		0.7	1	V
T_{RR}	Reverse recovery time	$V_{DD} = 20\text{ V}, I_D = 15\text{ A},$ $di/dt = 100\text{ A}/\mu\text{S}$		54		ns
Q_{RR}	Reverse recovery charge			60		nC
I_{RRM}	Peak Reverse Recovery Current			1.8		A

Electrical Characteristics Diagrams

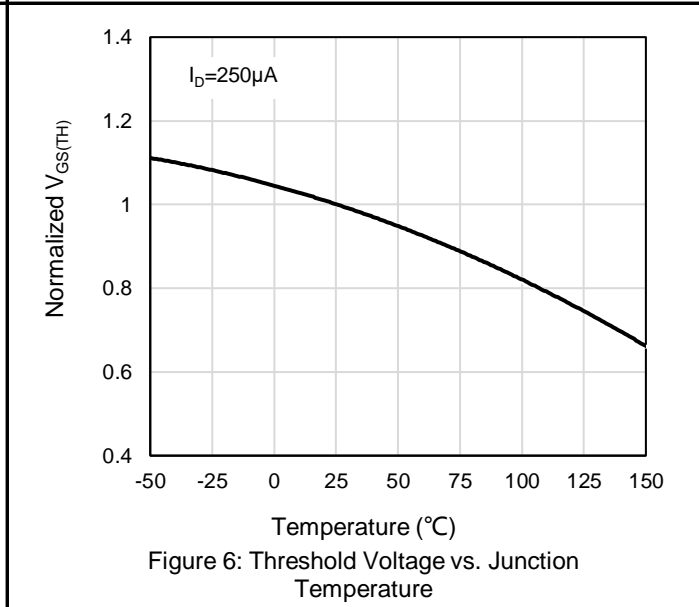
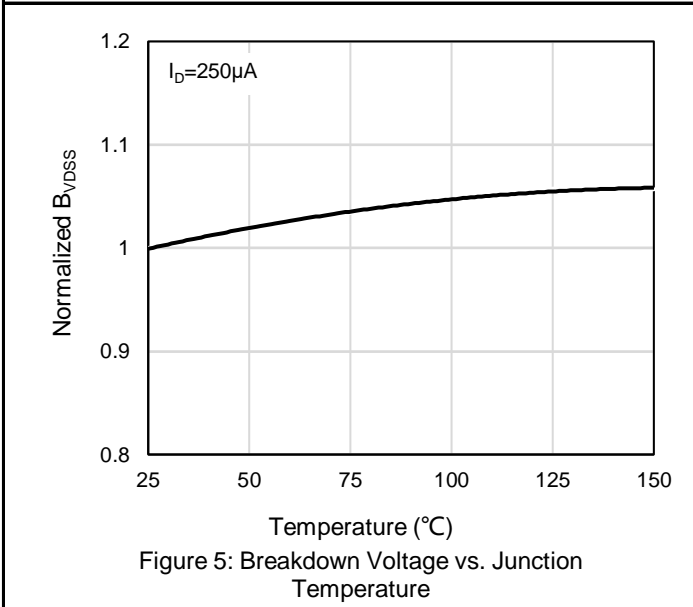
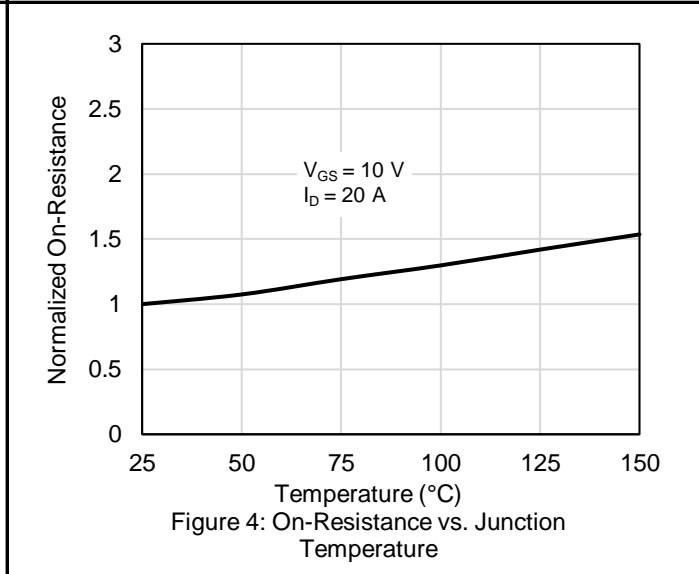
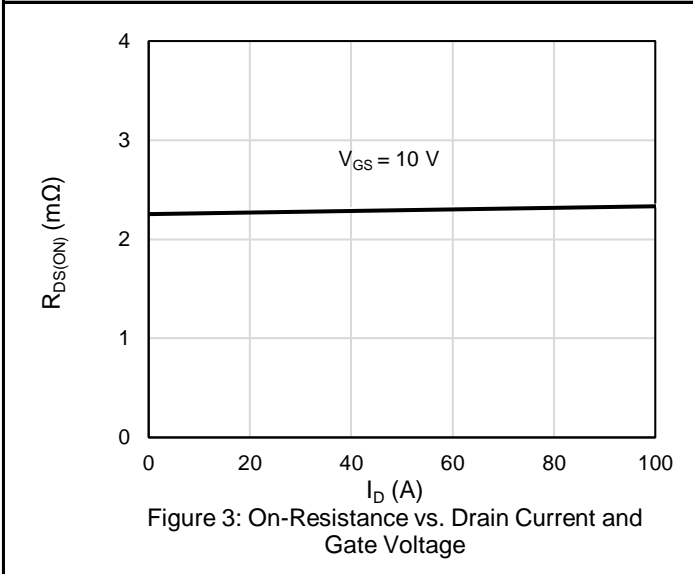
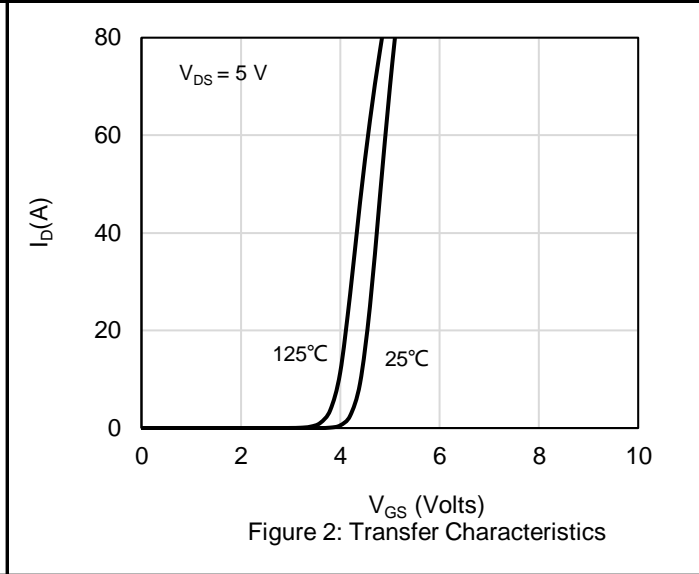
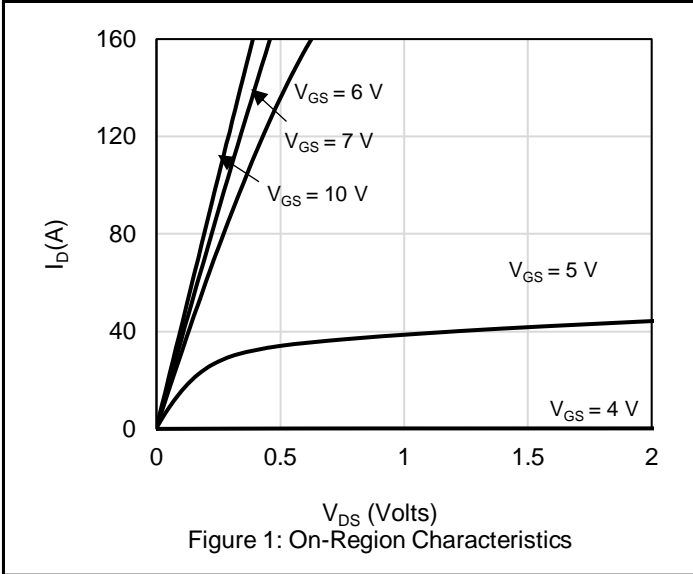

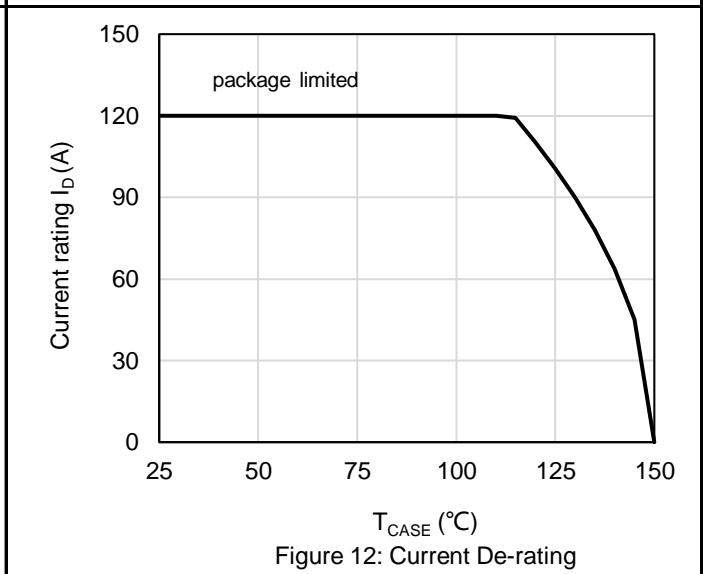
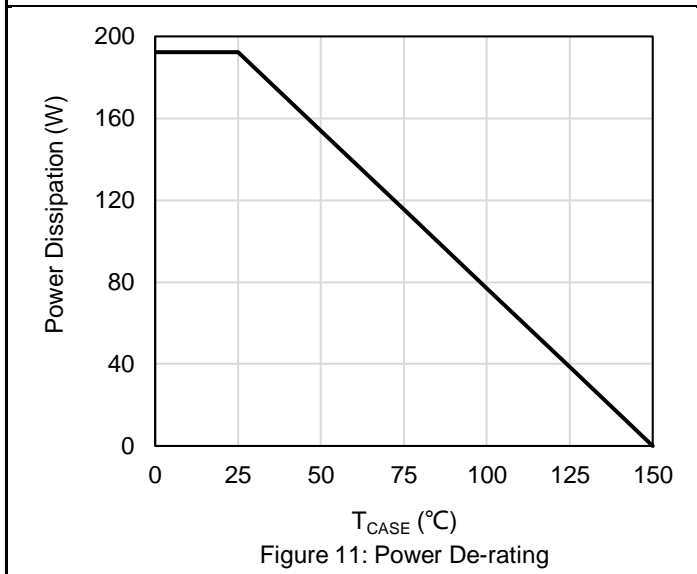
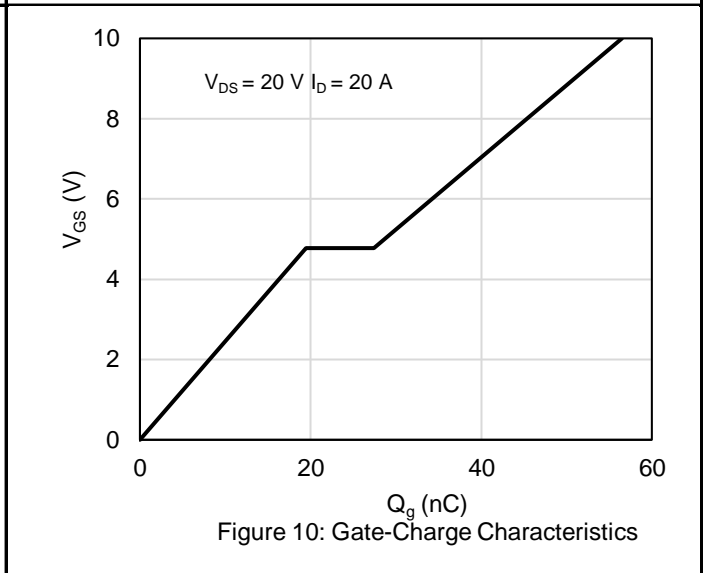
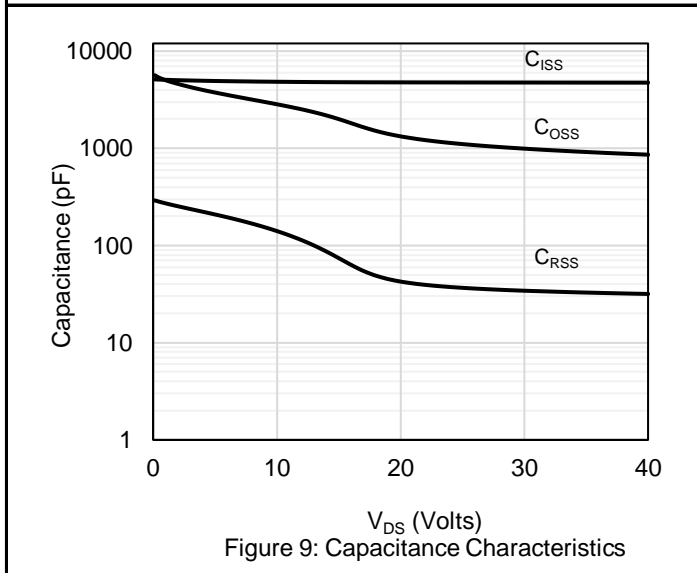
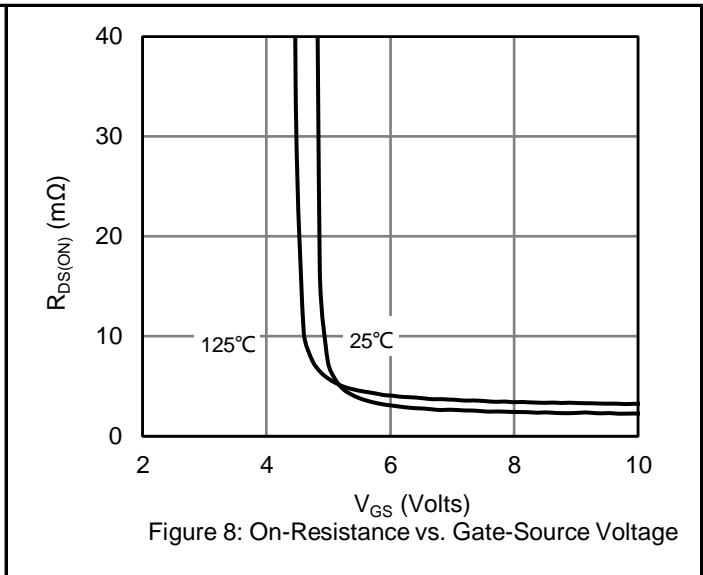
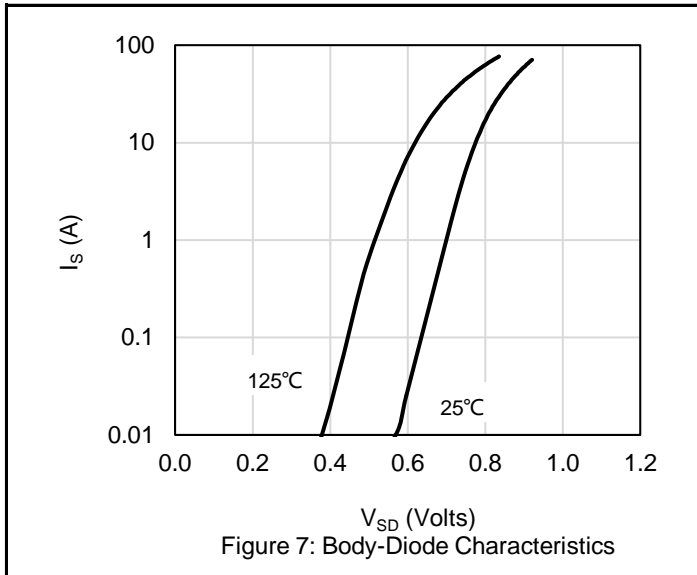

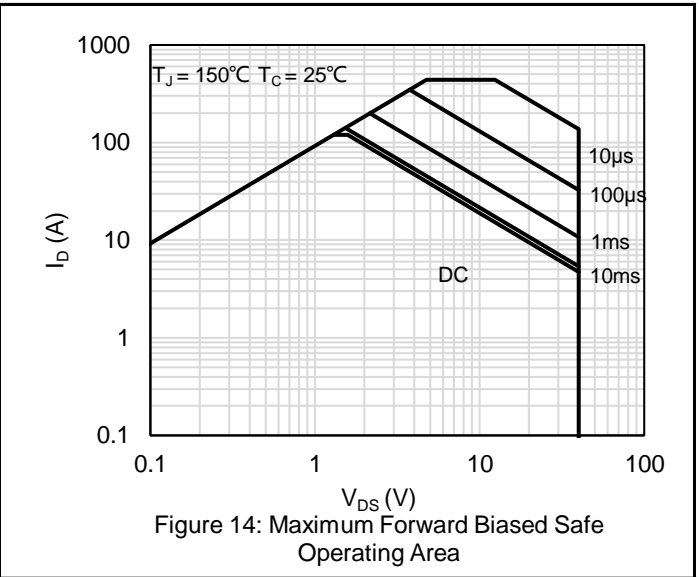
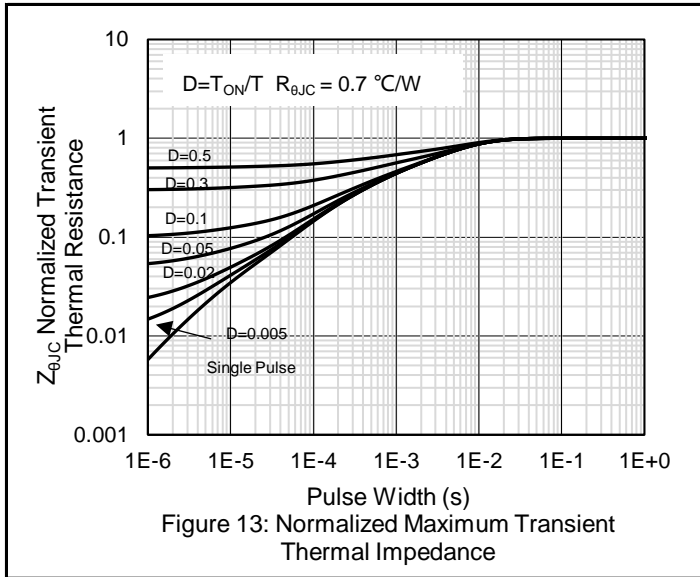

Test Circuit and Waveform

Gate Charge Test Circuit & Waveform

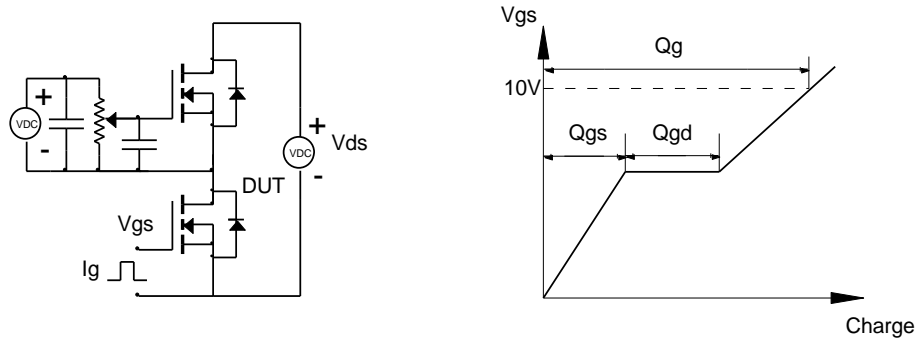

Resistive Switching Test Circuit & Waveforms

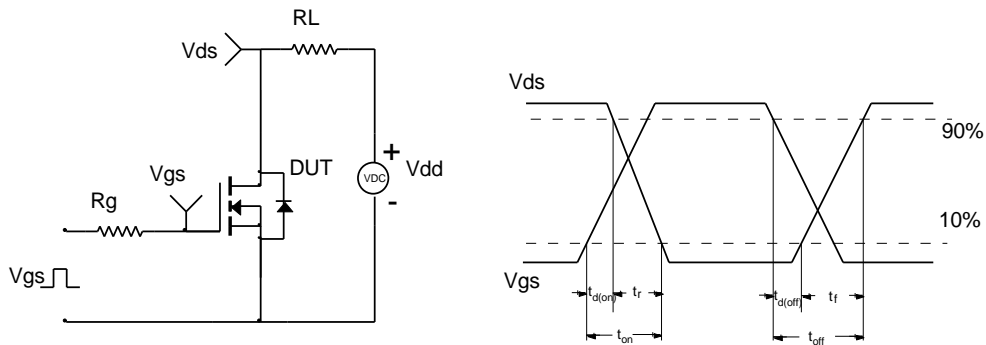

Unclamped Inductive Switching (UIS) Test Circuit & Waveforms

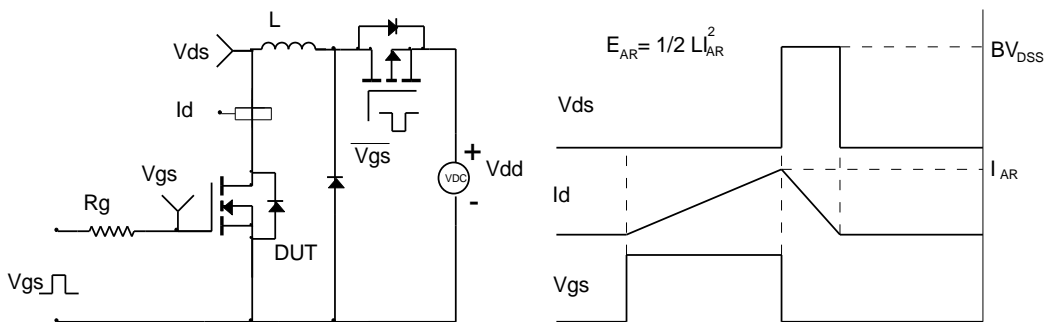

Diode Recovery Test Circuit & Waveforms

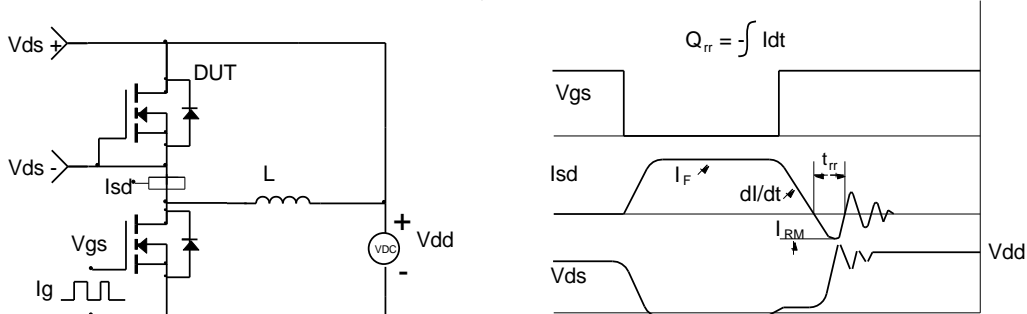

Package Outlines

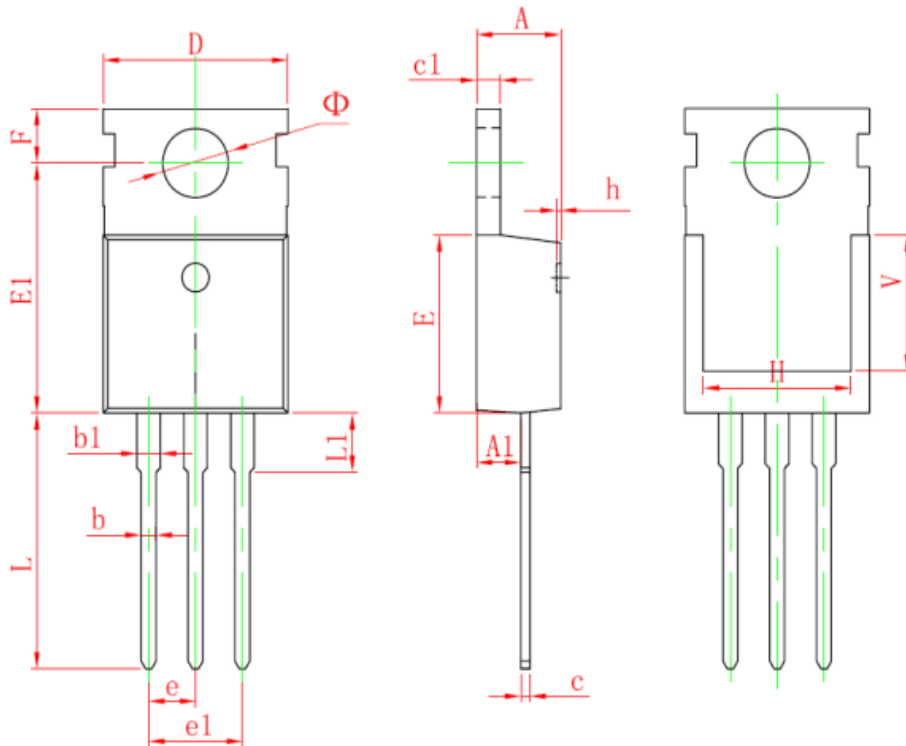

Symbol	Dimensions In Millimeters		Dimensions In Inches	
	Min.	Max.	Min.	Max.
A	4.400	4.600	0.173	0.181
A1	2.250	2.550	0.089	0.100
b	0.710	0.910	0.028	0.036
b1	1.170	1.370	0.046	0.054
c	0.330	0.650	0.013	0.026
c1	1.200	1.400	0.047	0.055
D	9.910	10.250	0.390	0.404
E	8.950	9.750	0.352	0.384
E1	12.650	13.050	0.498	0.514
e	2.540 TYP.		0.100 TYP.	
e1	4.980	5.180	0.196	0.204
F	2.650	2.950	0.104	0.116
H	7.900	8.100	0.311	0.319
h	0.000	0.300	0.000	0.012
L	12.900	13.400	0.508	0.528
L1	2.850	3.250	0.112	0.128
V	6.900 REF.		0.276 REF.	
Φ	3.400	3.800	0.134	0.150

Marking Information



G4N024PM
XXXXXXXX

Note:

G4N024PM = Product Name Code

XXXXXXXX = Date code

Contact ALKAIDSEMI sales for detail information

Revision History

Revision	Release Date	Remark
Rev.1.0	2022/2/24	Initial Release

Disclaimer

The information given in this document describes the independent performance of the product, but similar performance is not guaranteed under other working conditions, and cannot be guaranteed when installed with other products or equipment. To achieve the required performance of the product in actual scenarios, the customer should conduct a complete application test to assess the functionality of the product.

Alkaidsemi assumes no responsibility for equipment failures result from using products at values that exceed the ratings, operating conditions, or other parameters listed in the product specifications.

The product described in this specification is not applicable for aerospace or other applications which requires high reliability. Customers using or selling these products for use in medical, life-saving, or life-sustaining applications do so at their own risk and agree to fully indemnify.

Due to product or technical improvements, the information described or contained herein may be changed without prior notice.