

# 100V 4.2mohm N-channel SGT MOSFET

## AKG10N042DM

### Description:

This N channel SGT MOSFET has been designed to low on-state resistance and superior  $E_{AS}$  performance, especially for BMS and Motor driving applications.

### Features:

- Low FOM  $R_{DS(ON)} \times Q_G$
- Ultra-low on-resistance
- RoHS compliant <sup>(Note 1)</sup>
- Halogen-free <sup>(Note 1)</sup>

### Applications:

- Battery Management System
- Motor Drivers
- DC-DC Converter

### Key Performance Parameters:

Parameter	Value	Unit
$V_{DS}$	100	V
$R_{DS(ON), max} @ V_{GS} = 10V$	4.2	m $\Omega$
$I_D$	120	A

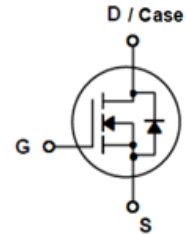
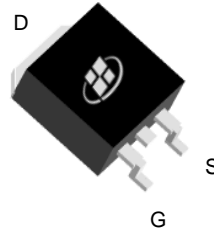

### Ordering Information:

Ordering Code	Package Type	Marking Code	Form	Packing
AKG10N042DM	TO263	G10N042DM	13 Inches Reel	1000PCS

### Notes:

1. Contact ALKAIDSEMI sales for detail information

**Maximum Ratings** ( $T_A = 25^\circ\text{C}$  unless otherwise noted)

Symbol	Parameter	Value	Units
$V_{DS}$	Drain-Source Voltage	100	V
$I_D$	Drain Current - Continuous ( $T_C = 25^\circ\text{C}$ ) <sup>(Note 1)</sup>	158	A
	Drain Current - Continuous ( $T_C = 25^\circ\text{C}$ ) <sup>(Note 2)</sup>	120	A
	Drain Current - Continuous ( $T_C = 100^\circ\text{C}$ )	100	A
$I_{DM}$	Drain Current - Pulsed <sup>(Note 3)</sup>	460	A
$V_{GS}$	Gate-Source Voltage	$\pm 20$	V
$E_{AS}$	Single Pulsed Avalanche Energy <sup>(Note 4)</sup>	317	mJ
$P_D$	Power Dissipation ( $T_C = 25^\circ\text{C}$ )	178	W
$T_J, T_{STG}$	Operating and Storage Temperature Range	-55 to +150	$^\circ\text{C}$

**Thermal Characteristics**

Symbol	Parameter	Value	Units
$R_{\theta JC}$	Thermal Resistance, Junction-to-Case, Steady-State	0.7	$^\circ\text{C/W}$
$R_{\theta JA}$	Thermal Resistance, Junction-to-Ambient, Steady State <sup>(Note 5)</sup>	54	$^\circ\text{C/W}$

**Notes:**

1. The max drain current rating is silicon limited
2. The max drain current rating is package limited
3. Repetitive Rating: Pulse width limited by maximum junction temperature
4.  $L = 0.5 \text{ mH}$ ,  $V_{DD} = 50\text{V}$ ,  $I_{AS} = 35.6 \text{ A}$ ,  $R_G = 25 \Omega$ , Starting  $T_J = 25^\circ\text{C}$
5. Mount on minimum PCB layout

**Electrical Characteristics** ( $T_J = 25^\circ\text{C}$  unless otherwise noted)

Symbol	Parameter	Test Conditions	Min	Typ	Max	Units
--------	-----------	-----------------	-----	-----	-----	-------

**Static Characteristics**

$BV_{DSS}$	Drain-Source Breakdown Voltage	$V_{GS} = 0\text{ V}, I_D = 1\text{ mA}$	100			V
$I_{DSS}$	Zero Gate Voltage Drain Current	$V_{DS} = 100\text{ V}, V_{GS} = 0\text{ V}$			1	$\mu\text{A}$
$I_{GSS}$	Gate Leakage Current	$V_{GS} = \pm 20\text{ V}, V_{DS} = 0\text{ V}$			$\pm 100$	nA
$V_{GS(TH)}$	Gate Threshold voltage	$V_{DS} = V_{GS}, I_D = 250\text{ }\mu\text{A}$	2	3	4	V
$R_{DS(ON)}$	Drain-Source on-state resistance	$V_{GS} = 10\text{ V}, I_D = 20\text{ A}$		3.7	4.2	m $\Omega$

**Dynamic Characteristics**

$C_{ISS}$	Input Capacitance	$V_{DS} = 50\text{ V}, V_{GS} = 0\text{ V},$ $F = 1\text{ MHz}$		6070		pF
$C_{OSS}$	Output Capacitance			1320		pF
$C_{RSS}$	Reverse Transfer Capacitance			65		pF
$R_G$	Gate Resistance	$F = 1\text{ MHz}$		1.6		$\Omega$

**Switching Characteristics**

$T_{D(ON)}$	Turn On Delay Time	$V_{DD} = 50\text{ V}, R_L = 2.5\text{ }\Omega,$ $V_{GS} = 10\text{ V}, R_G = 6\text{ }\Omega$		31		nS
$T_R$	Rise Time			77		nS
$T_{D(OFF)}$	Turn Off Delay Time			76		nS
$T_F$	Fall Time			61		nS
$Q_G$	Total Gate Charge	$V_{DD} = 50\text{ V}, I_D = 20\text{ A},$ $V_{GS} = 10\text{ V}$		88		nC
$Q_{GS}$	Gate-Source Charge			25		nC
$Q_{GD}$	Gate-Drain Charge			18		nC

**Drain-Source Diode Characteristics and Maximum Ratings**

$I_S$	Maximum Continuous Body-Diode Forward Current				120	A
$I_{SM}$	Maximum Pulsed Body-Diode Forward Current <sup>(NOTE 2)</sup>				460	A
$V_{SD}$	Diode Forward Voltage	$V_{GS} = 0\text{ V}, I_S = 1\text{ A}$		0.7		V
$T_{RR}$	Reverse recovery time	$V_{DD} = 50\text{ V}, I_D = 20\text{ A},$ $di/dt = 100\text{ A}/\mu\text{S}$		67		nS
$Q_{RR}$	Reverse recovery charge			155		nC
$I_{RRM}$	Peak Reverse Recovery Current			4		A

# Electrical Characteristics Diagrams

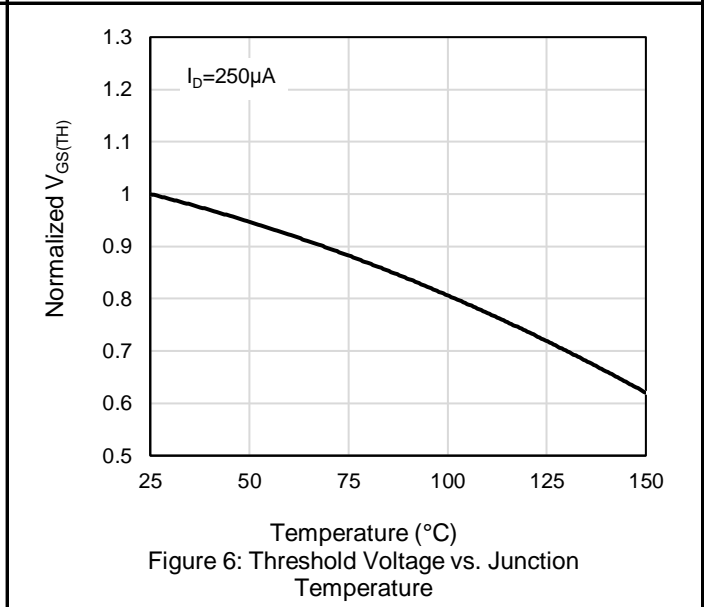
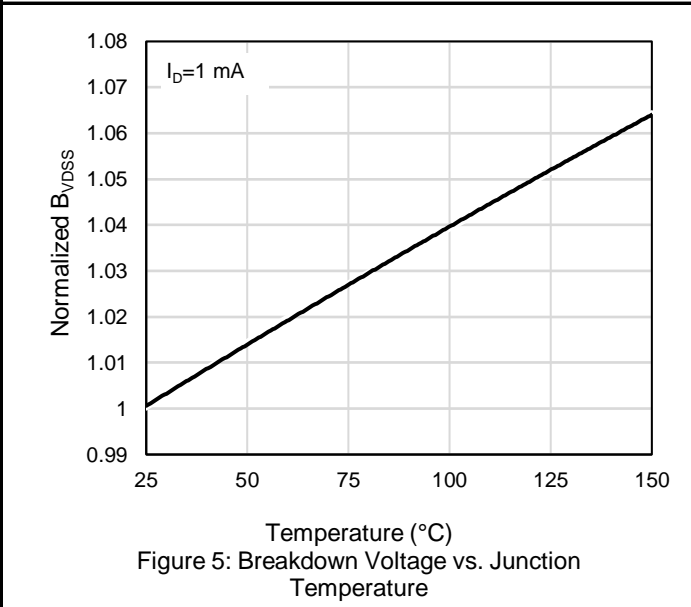
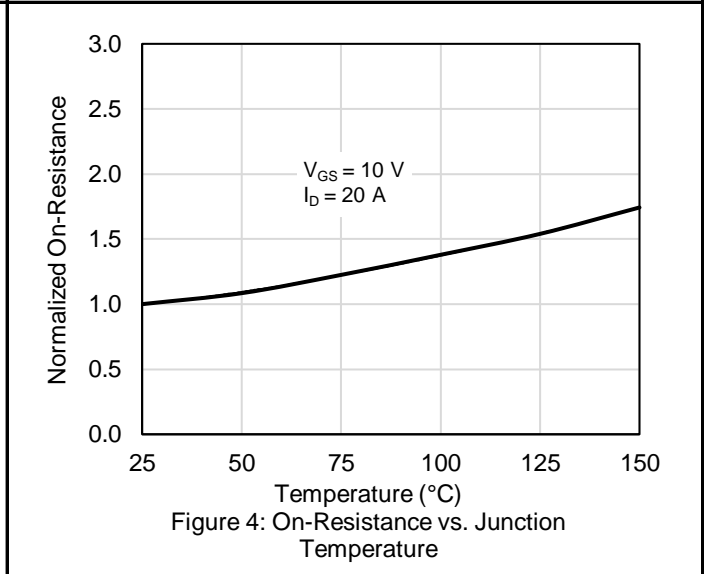
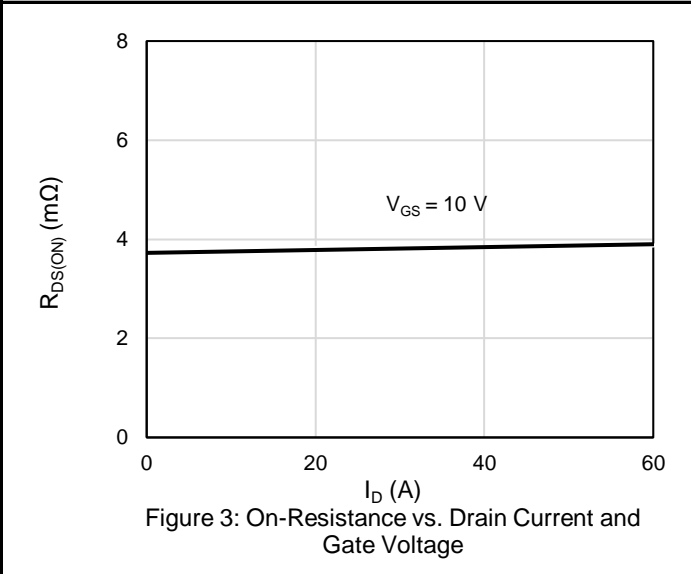
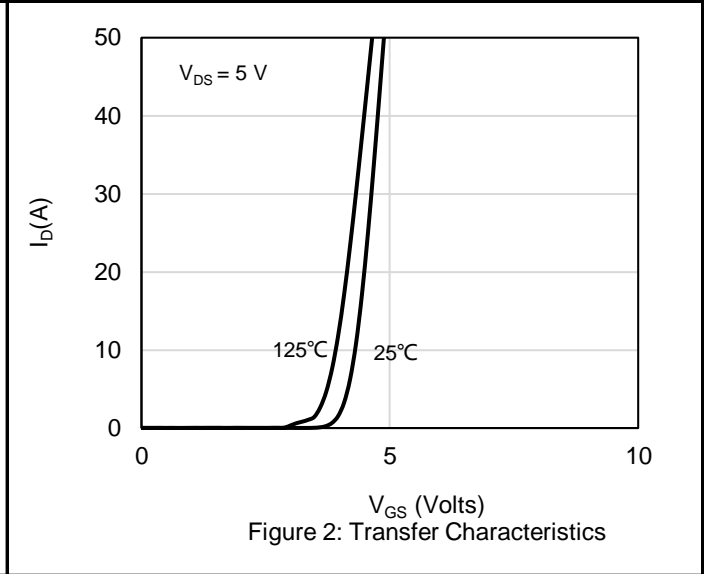
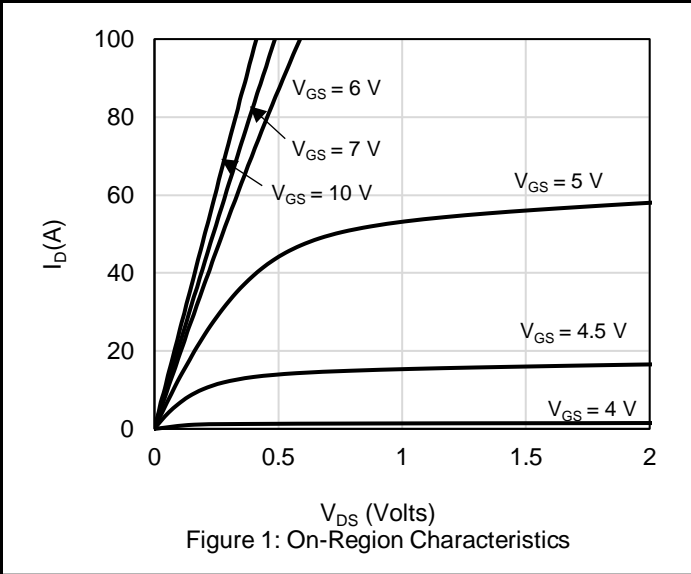

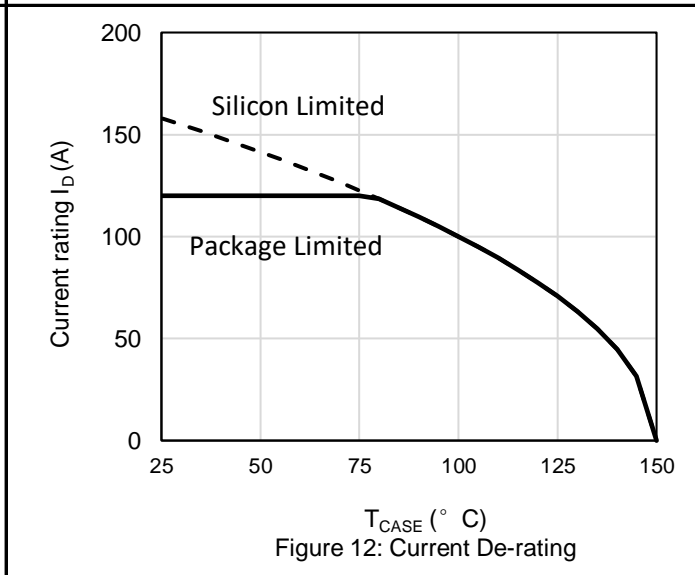
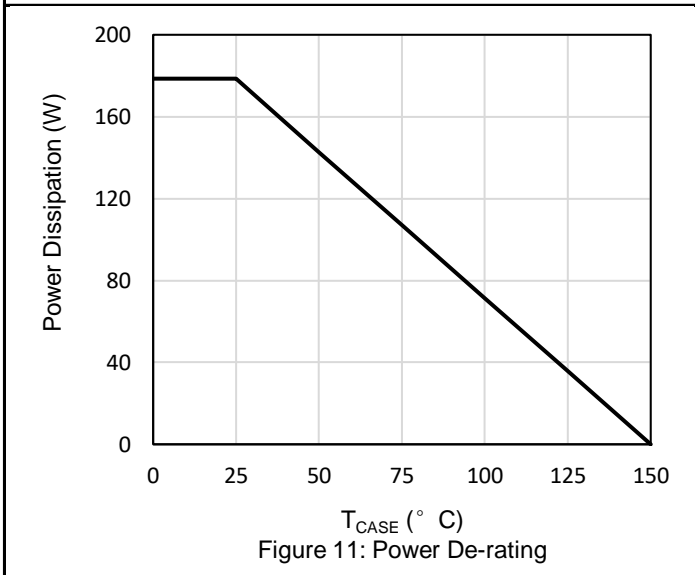
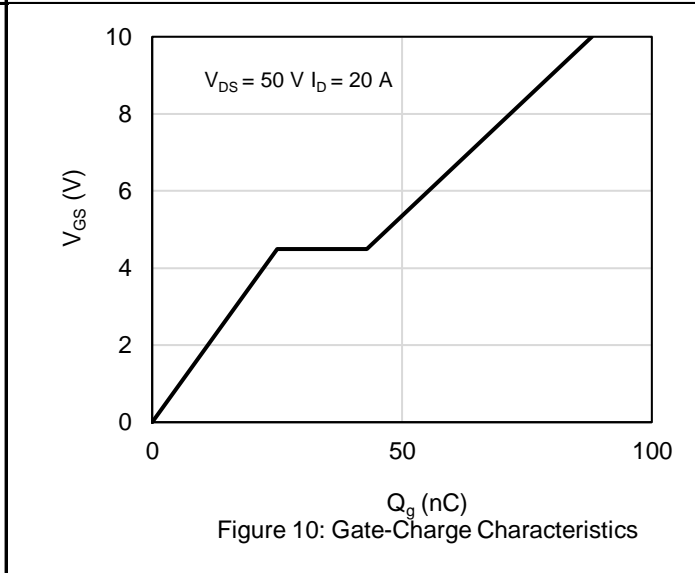
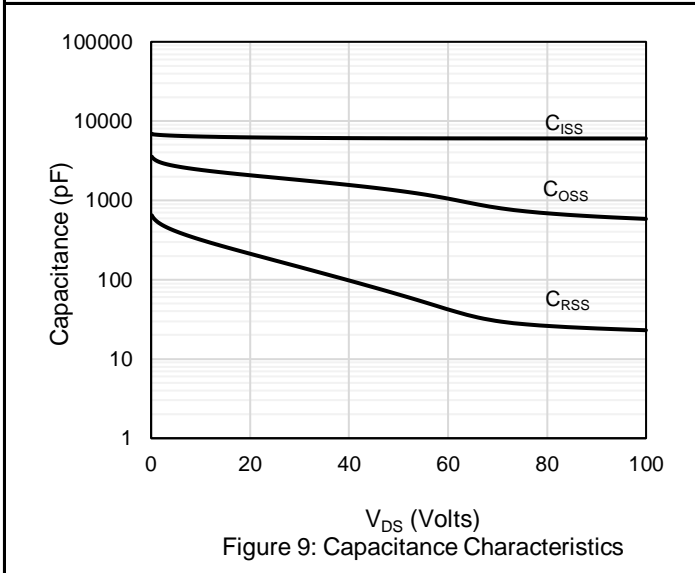
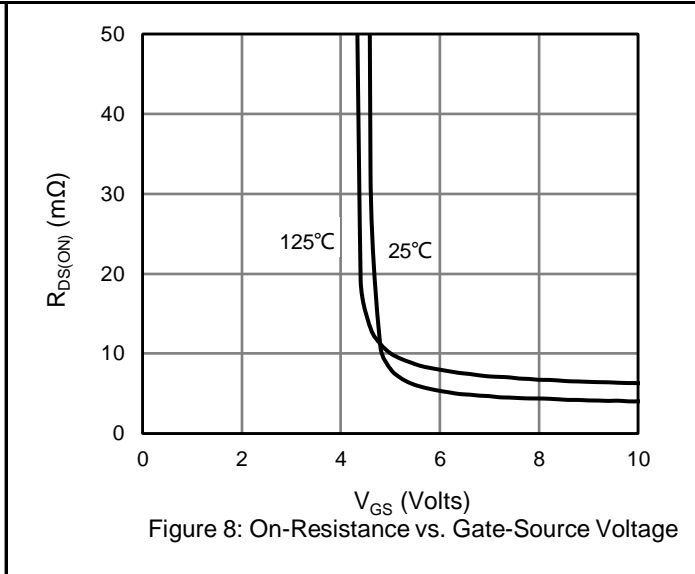
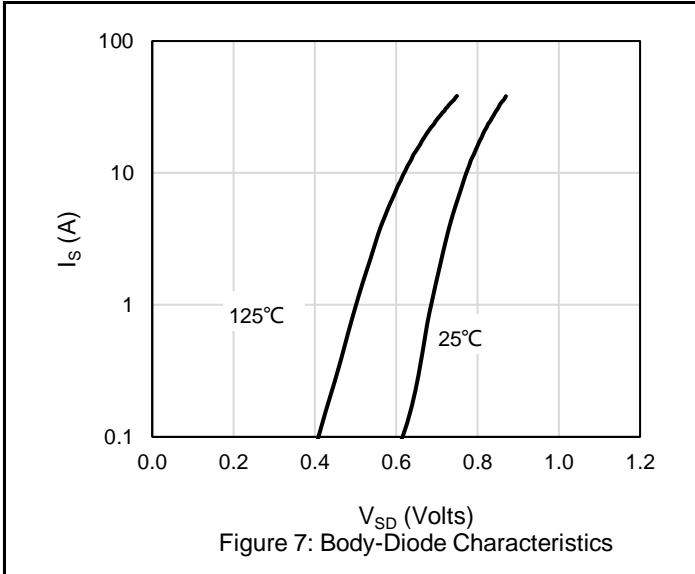

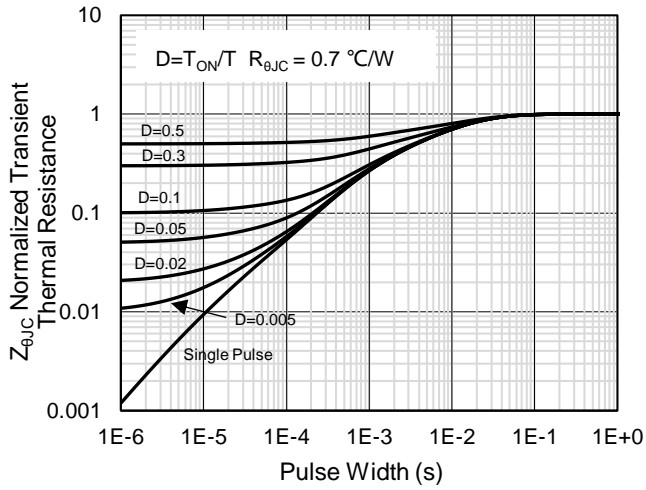

Figure 13: Normalized Maximum Transient Thermal Impedance

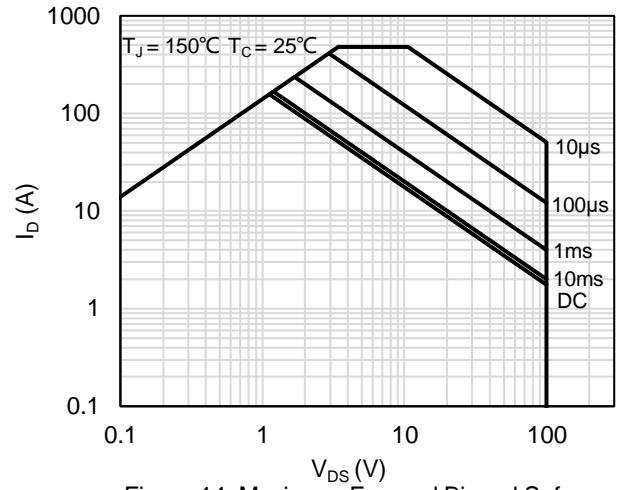
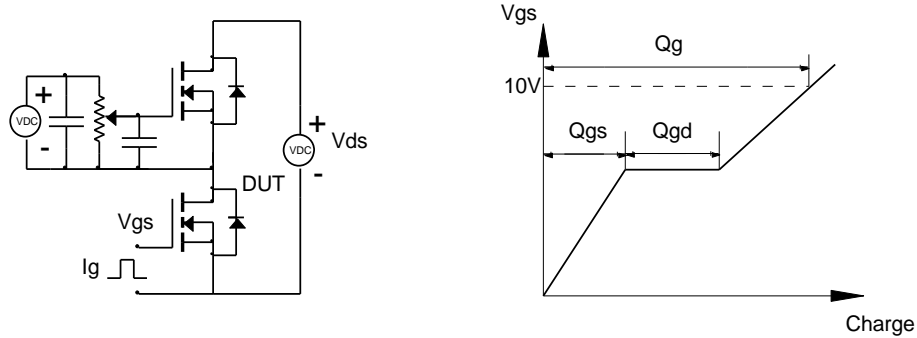

Figure 14: Maximum Forward Biased Safe Operating Area

# Test Circuit and Waveform

Gate Charge Test Circuit & Waveform



Resistive Switching Test Circuit & Waveforms

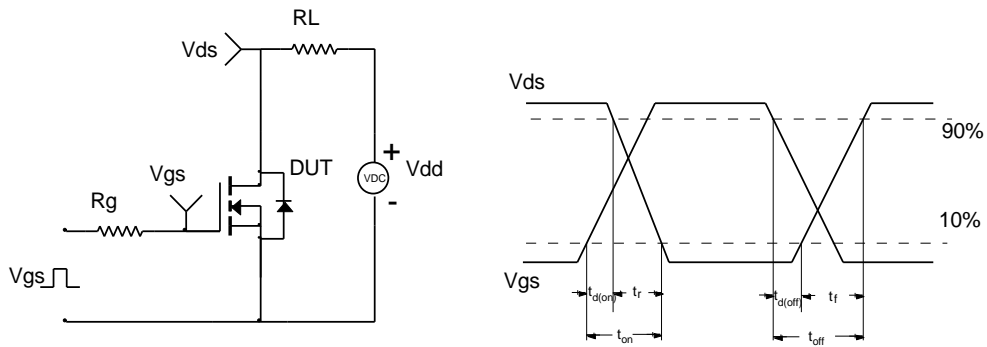

Unclamped Inductive Switching (UIS) Test Circuit & Waveforms

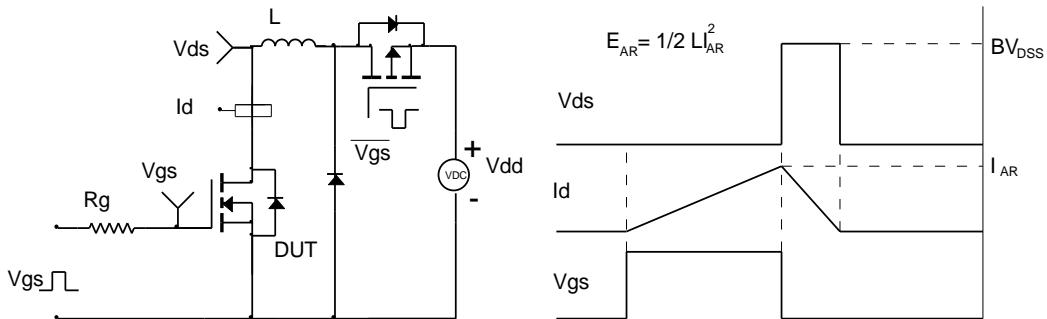

Diode Recovery Test Circuit & Waveforms

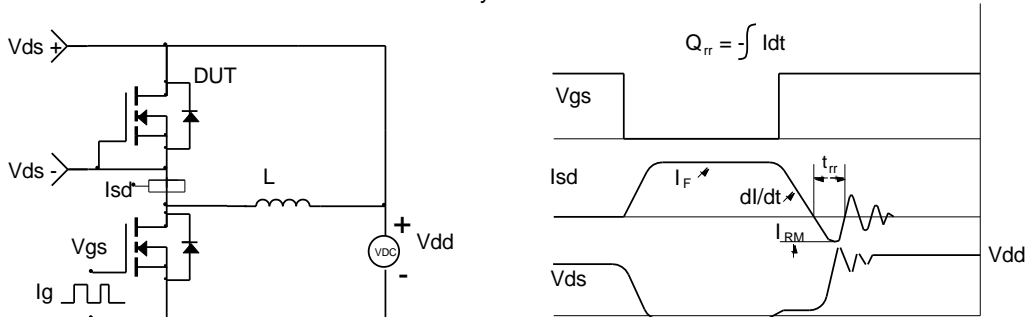

# Package Outlines

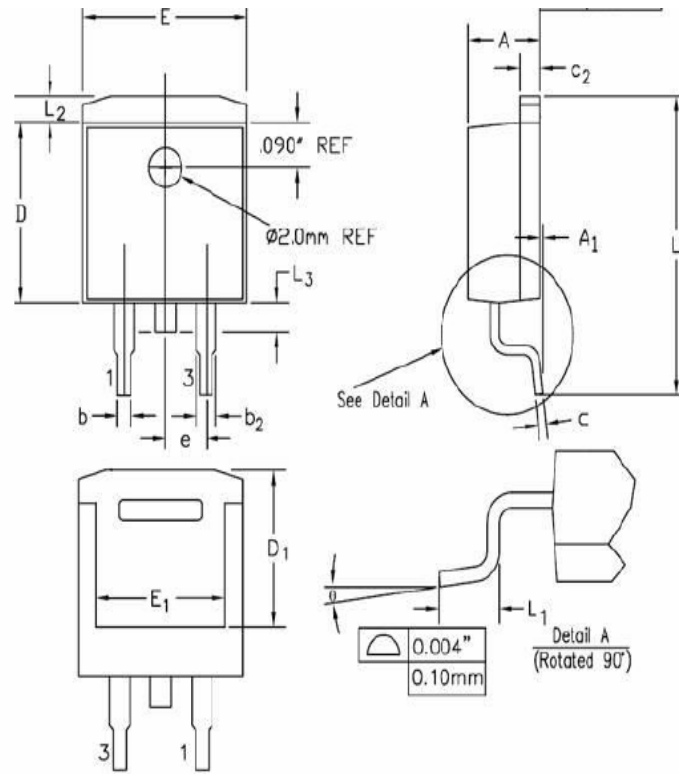

SYMBOL	INCHES		MILLIMETERS		NOTES
	MIN	MAX	MIN	MAX	
A	0.170	0.180	4.32	4.57	
A1	-	0.010	-	0.25	
b	0.028	0.037	0.71	0.94	
b2	0.045	0.055	1.15	1.40	
c	0.018	0.024	0.46	0.61	
c2	0.048	0.055	1.22	1.40	
D	0.350	0.370	8.89	9.40	
D1	0.315	0.324	8.01	8.23	
E	0.395	0.405	10.04	10.28	
E1	0.310	0.318	7.88	8.08	
e	0.100 BSC.		2.54 BSC.		
L	0.580	0.620	14.73	15.75	
L1	0.090	0.110	2.29	2.79	
L2	0.045	0.055	1.15	1.39	
L3	0.050	0.070	1.27	1.77	
θ	0°	8°	0°	8°	



## Marking Information



Note:  
 G10N042DM = Product Name Code  
 XXXXXXXX = Date code  
 Contact ALKAIDSEMI sales for detail information

## Tape & Reel Information

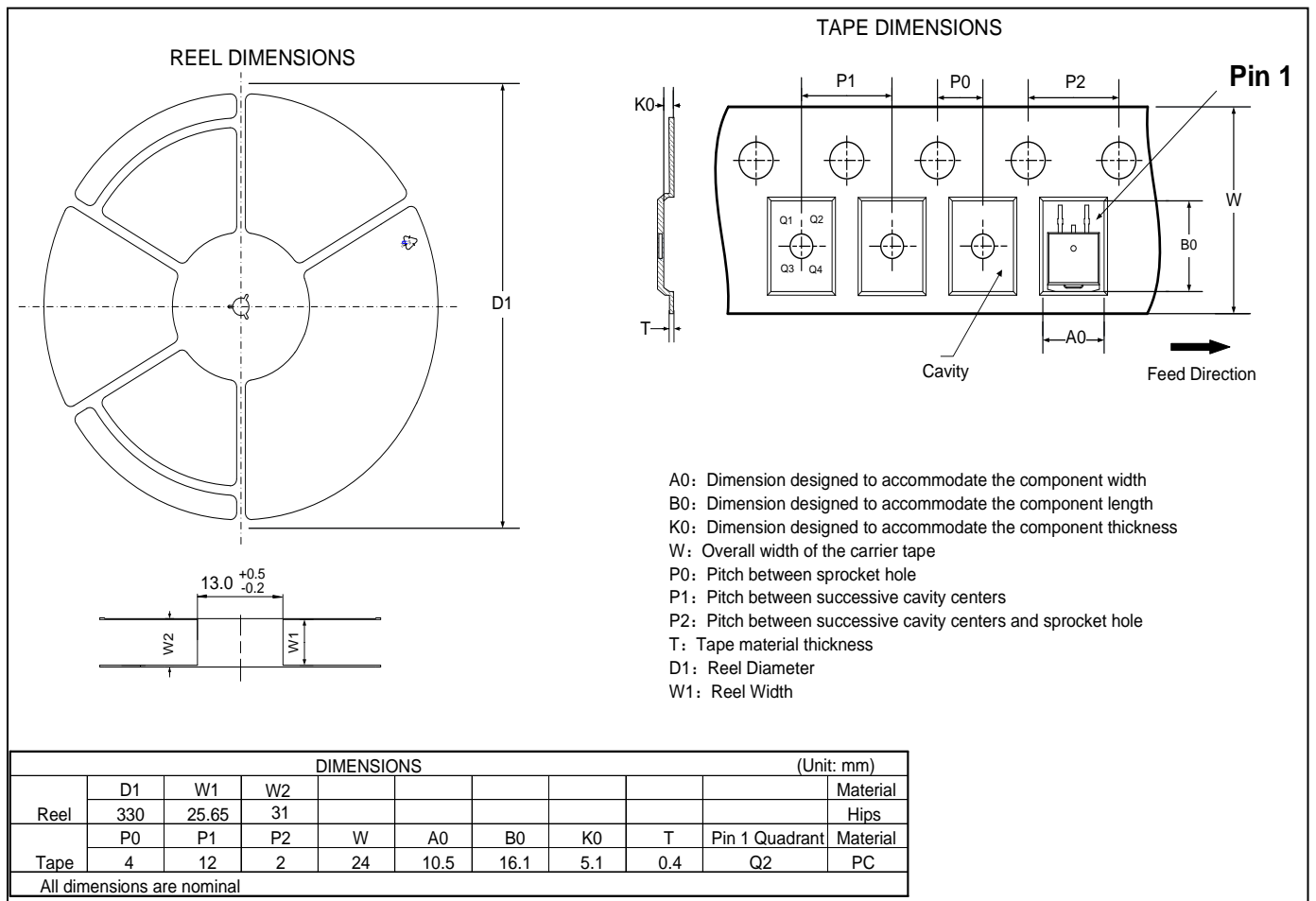

---

## Revision History

Revision	Release Date	Remark
Rev.1.1	2023/2/15	

## Disclaimer

The information given in this document describes the independent performance of the product, but similar performance is not guaranteed under other working conditions, and cannot be guaranteed when installed with other products or equipment. To achieve the required performance of the product in actual scenarios, the customer should conduct a complete application test to assess the functionality of the product.

Alkaidsemi assumes no responsibility for equipment failures result from using products at values that exceed the ratings, operating conditions, or other parameters listed in the product specifications.

The product described in this specification is not applicable for aerospace or other applications which requires high reliability. Customers using or selling these products for use in medical, life-saving, or life-sustaining applications do so at their own risk and agree to fully indemnify.

Due to product or technical improvements, the information described or contained herein may be changed without prior notice.