

100V 10mohm N-channel SGT MOSFET

AKG100N10G

Description:

This N channel SGT MOSFET has been designed to low on-state resistance low switching loss with good E_{AS} performance, especially for DC-DC and Motor driving applications.

Features:

- Ultra-low on-resistance
- RoHS compliant ^(Note 1)
- Halogen-free ^(Note 1)

Applications:

- Battery Management System
- Motor Drivers
- DC-DC Converter

Key Performance Parameters:

Parameter	Value	Unit
V_{DS}	100	V
$R_{DS(on), max} @ V_{GS} = 10V$	10	m Ω
I_D	55	A

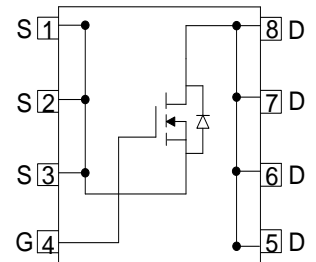
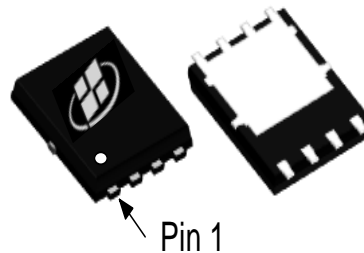

Ordering Information:

Ordering Code	Package Type	Marking Code	Form	Packing
AKG100N10G	DFN5X6	G100N10G	Tape Reel	5000PCS

Notes:

1. Contact ALKAIDSEMI sales for detail information

Maximum Ratings ($T_A = 25^\circ\text{C}$ unless otherwise noted)

Symbol	Parameter	Value	Units
V_{DS}	Drain-Source Voltage	100	V
I_D	Drain Current - Continuous ($T_C = 25^\circ\text{C}$) ^(Note 1)	55	A
	Drain Current - Continuous ($T_C = 100^\circ\text{C}$)	35	A
I_{DM}	Drain Current - Pulsed ^(Note 2)	220	A
V_{GS}	Gate-Source Voltage	± 20	V
E_{AS}	Single Pulsed Avalanche Energy ^(Note 3)	90	mJ
P_D	Power Dissipation ($T_C = 25^\circ\text{C}$)	57	W
T_J, T_{STG}	Operating and Storage Temperature Range	-55 to +150	$^\circ\text{C}$

Thermal Characteristics

Symbol	Parameter	Value	Units
$R_{\theta JC}$	Thermal Resistance, Junction-to-Case, Steady-State	2.2	$^\circ\text{C/W}$
$R_{\theta JA}$	Thermal Resistance, Junction-to-Ambient, Steady State ^(Note 4)	50	$^\circ\text{C/W}$

Notes:

1. The max drain current rating is package limited
2. Repetitive Rating: Pulse width limited by maximum junction temperature
3. $L = 0.5 \text{ mH}$, $V_{DD} = 50\text{V}$, $I_{AS} = 19 \text{ A}$, $R_G = 25 \Omega$, Starting $T_J = 25^\circ\text{C}$
4. Mount on minimum PCB layout

Electrical Characteristics ($T_J = 25^\circ\text{C}$ unless otherwise noted)						
Symbol	Parameter	Test Conditions	Min	Typ	Max	Units
Static Characteristics						
BV_{DSS}	Drain-Source Breakdown Voltage	$V_{GS} = 0\text{ V}, I_D = 250\ \mu\text{A}$	100			V
I_{DSS}	Zero Gate Voltage Drain Current	$V_{DS} = 100\text{ V}, V_{GS} = 0\text{ V},$			1	μA
I_{GSS}	Gate Leakage Current	$V_{GS} = \pm 20\text{ V}, V_{DS} = 0\text{ V}$			± 100	nA
$V_{GS(TH)}$	Gate Threshold voltage	$V_{DS} = V_{GS}, I_D = 250\ \mu\text{A}$	1.2	2	2.8	V
$R_{DS(ON)}$	Drain-Source on-state resistance	$V_{GS} = 10\text{ V}, I_D = 20\text{ A}$		8	10	m Ω
		$V_{GS} = 4.5\text{ V}, I_D = 15\text{ A}$		10.5	13.5	m Ω
Dynamic Characteristics						
C_{ISS}	Input Capacitance	$V_{DS} = 50\text{ V}, V_{GS} = 0\text{ V},$ $F = 1\text{ MHz}$		2198		pF
C_{OSS}	Output Capacitance			508		pF
C_{RSS}	Reverse Transfer Capacitance			23		pF
R_G	Gate Resistance	$F = 1\text{ MHz}$		4.7		Ω
Switching Characteristics						
$T_{D(ON)}$	Turn On Delay Time	$V_{DD} = 50\text{ V}, R_L = 2.5\ \Omega,$ $V_{GS} = 10\text{ V}, R_G = 6\ \Omega$		13		nS
T_R	Rise Time			38		nS
$T_{D(OFF)}$	Turn Off Delay Time			41		nS
T_F	Fall Time			52		nS
Q_G	Total Gate Charge	$V_{DD} = 50\text{ V}, I_D = 20\text{ A},$ $V_{GS} = 10\text{ V}$		35		nC
Q_{GS}	Gate-Source Charge			6		nC
Q_{GD}	Gate-Drain Charge			8		nC
Drain-Source Diode Characteristics and Maximum Ratings						
I_S	Maximum Continuous Body-Diode Forward Current			55		A
I_{SM}	Maximum Pulsed Body-Diode Forward Current ^(NOTE 1)			220		A
V_{SD}	Diode Forward Voltage	$V_{GS} = 0\text{ V}, I_S = 1\text{ A}$		0.7	1	V
T_{RR}	Reverse recovery time	$V_{DD} = 50\text{ V}, I_D = 15\text{ A},$ $di/dt = 100\text{ A}/\mu\text{S}$		53		ns
Q_{RR}	Reverse recovery charge			75		nC
I_{RRM}	Peak Reverse Recovery Current			2.4		A

Electrical Characteristics Diagrams

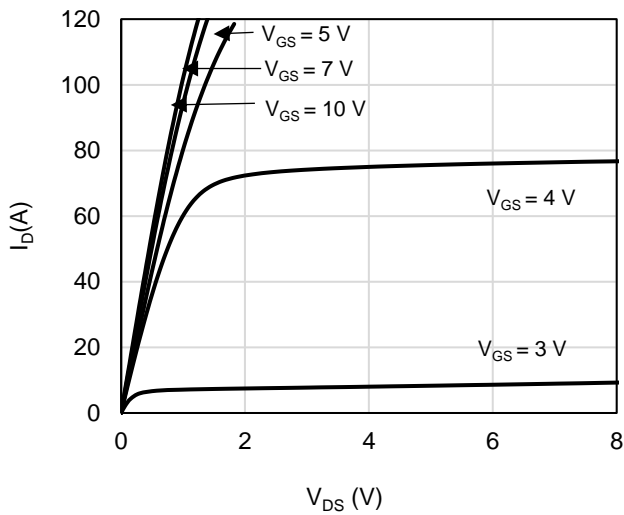

Figure 1: On-Region Characteristics

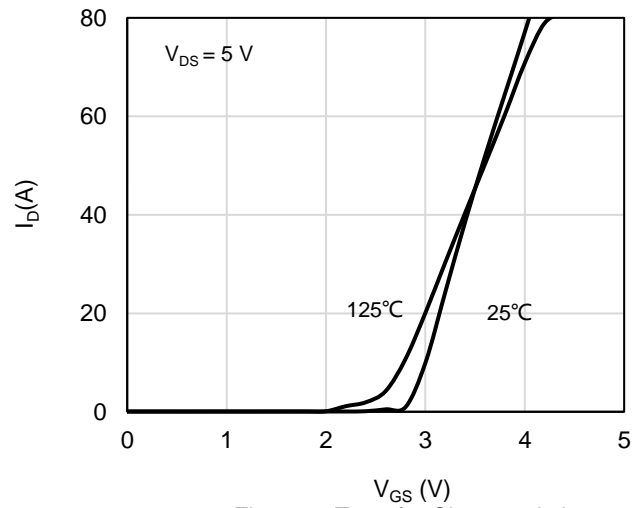

Figure 2: Transfer Characteristics

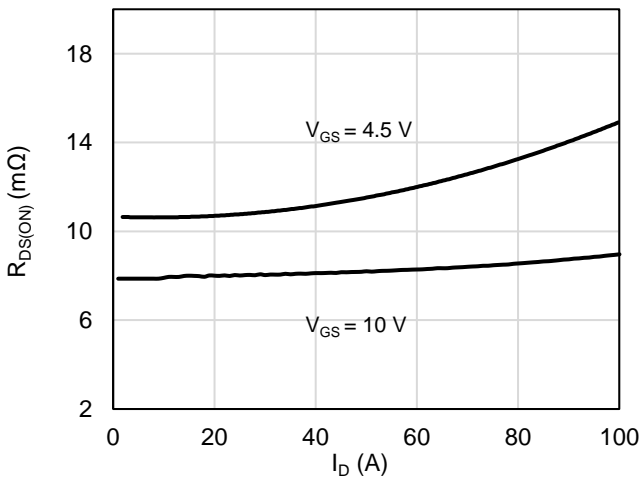

Figure 3: On-Resistance vs. Drain Current and Gate Voltage

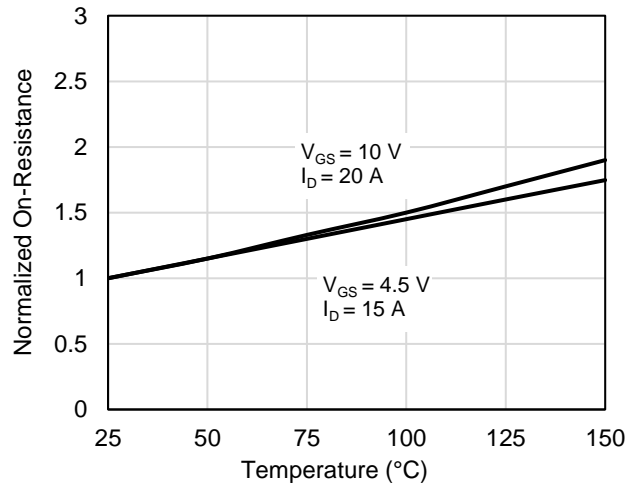

Figure 4: On-Resistance vs. Junction Temperature

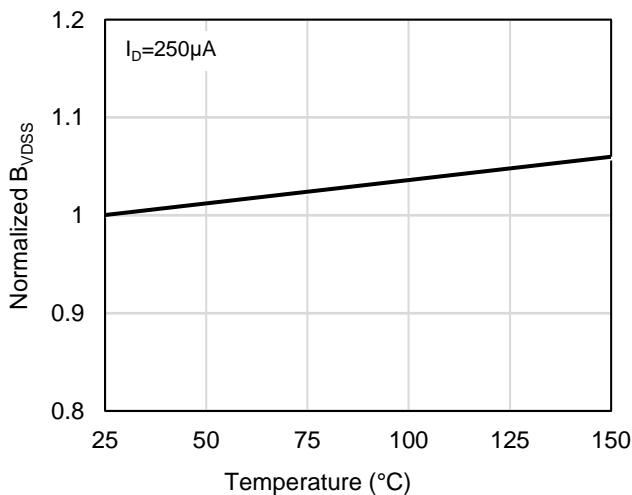

Figure 5: Breakdown Voltage vs. Junction Temperature

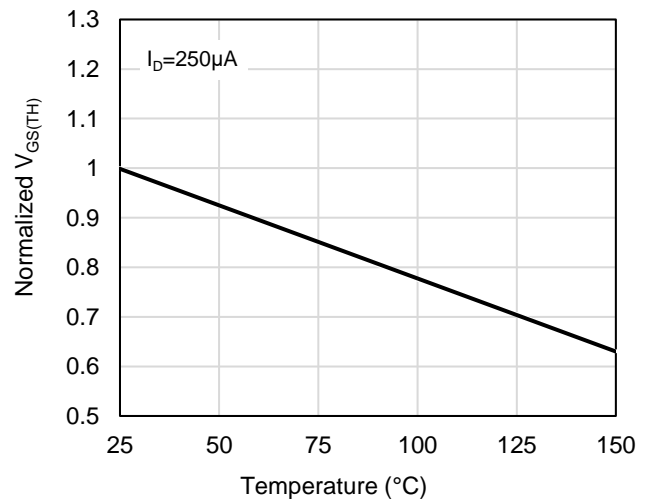
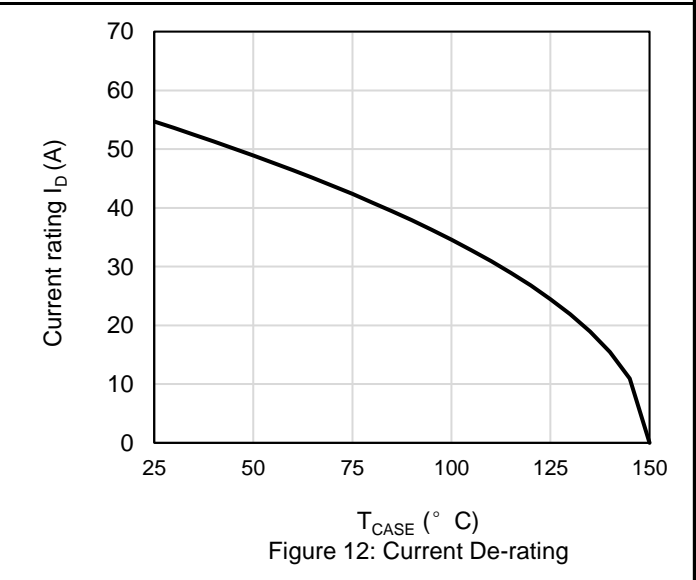
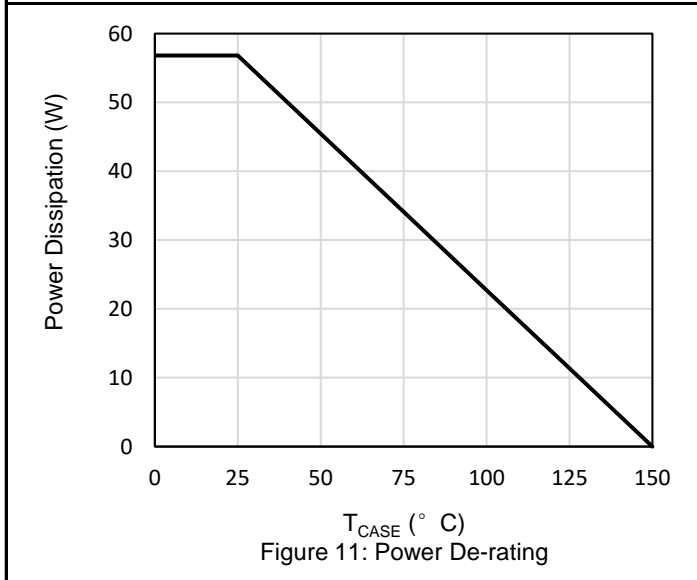
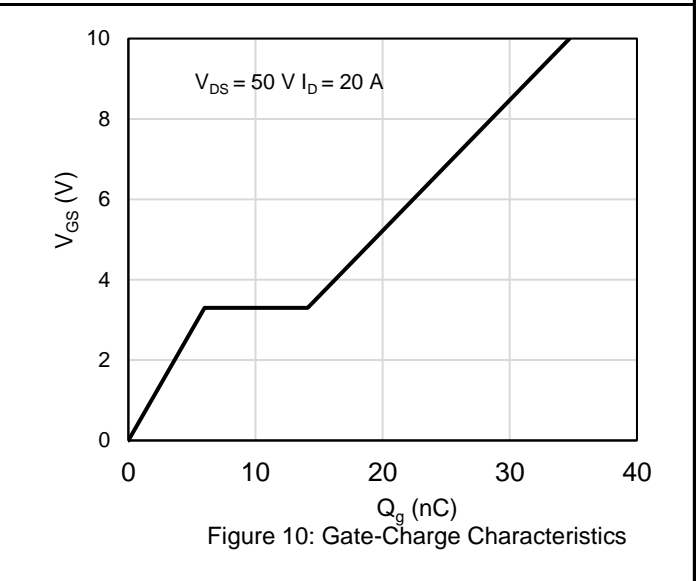
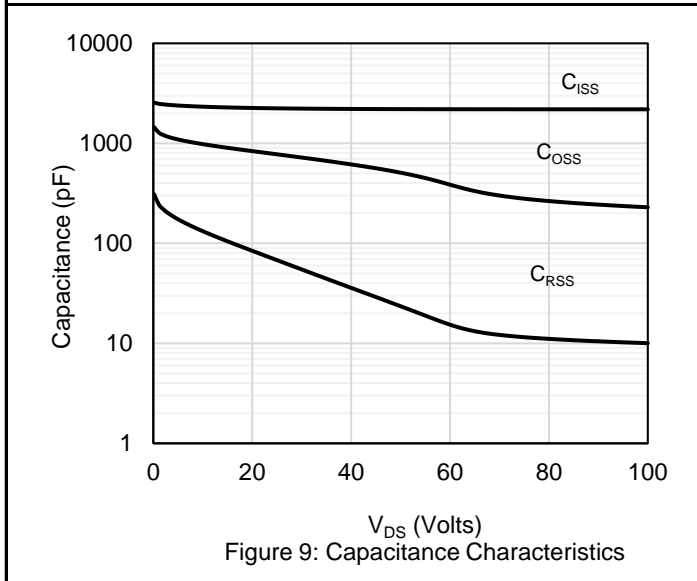
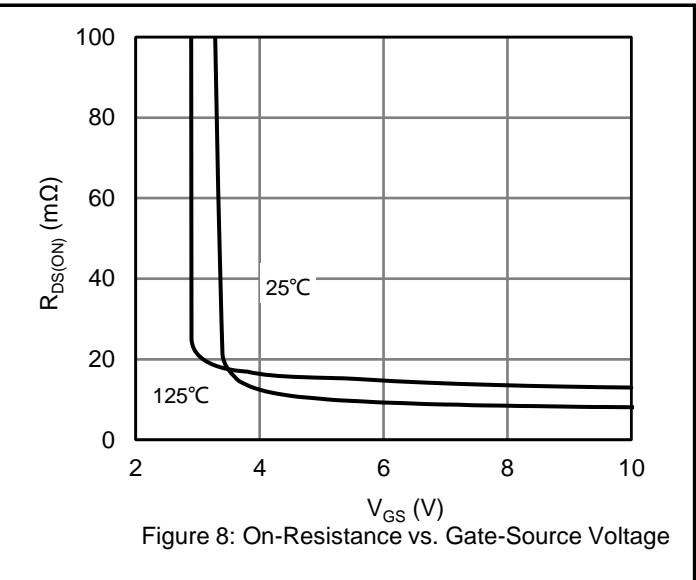
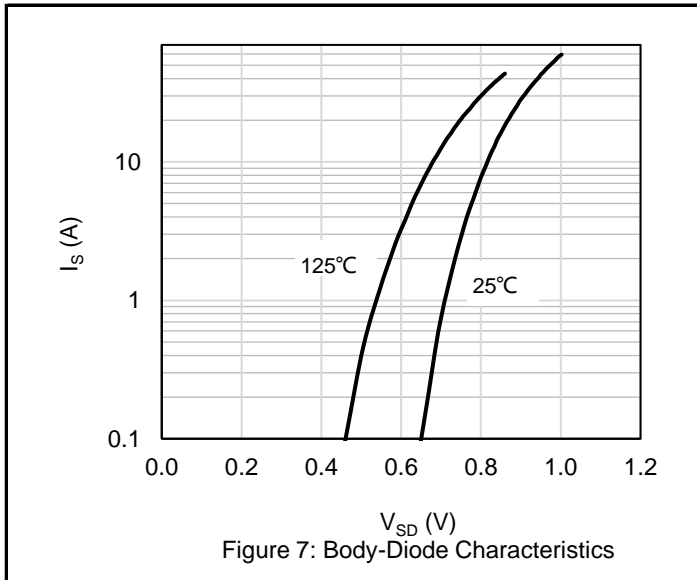

Figure 6: Threshold Voltage vs. Junction Temperature



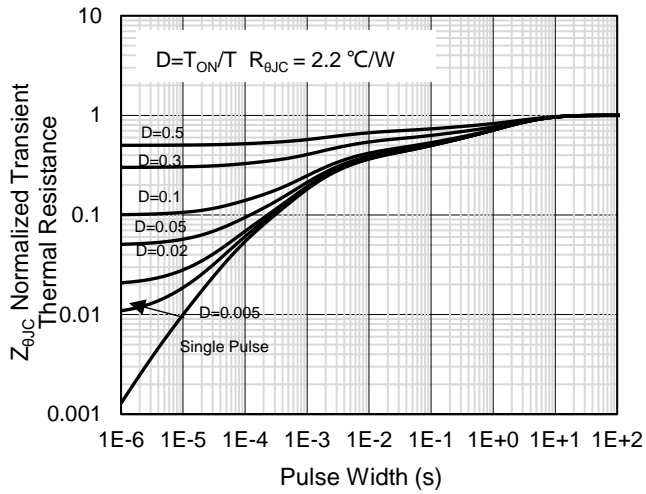

Figure 13: Normalized Maximum Transient Thermal Impedance

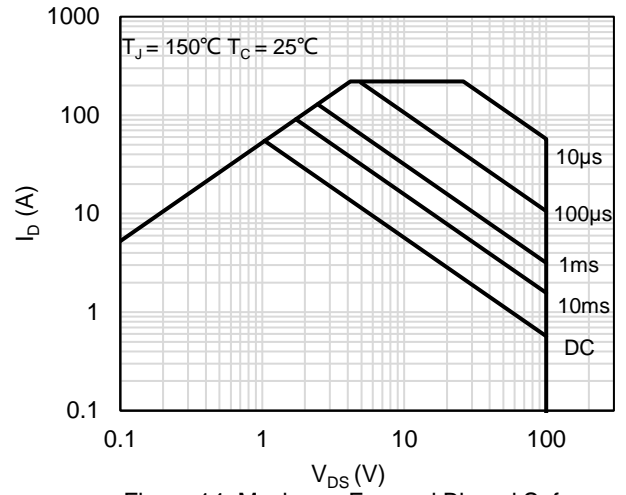
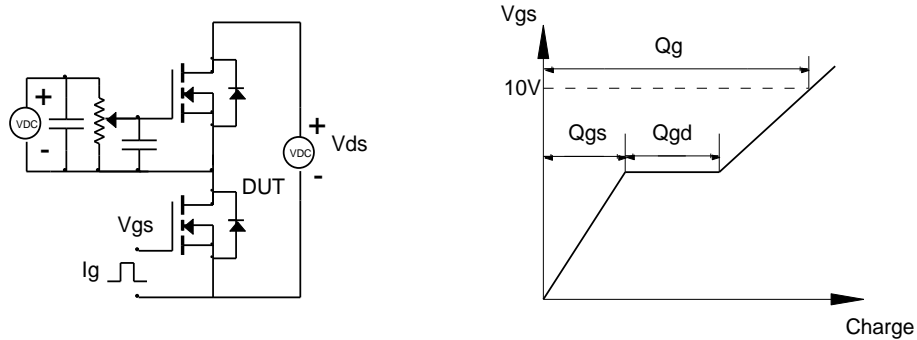

Figure 14: Maximum Forward Biased Safe Operating Area

Test Circuit and Waveform

Gate Charge Test Circuit & Waveform



Resistive Switching Test Circuit & Waveforms

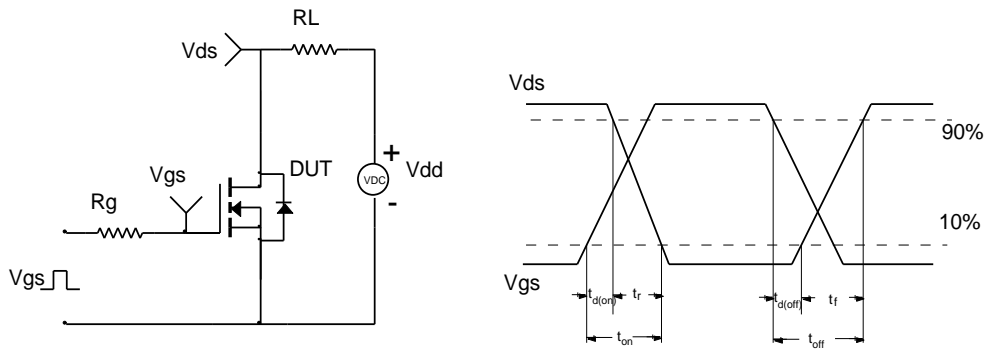

Unclamped Inductive Switching (UIS) Test Circuit & Waveforms

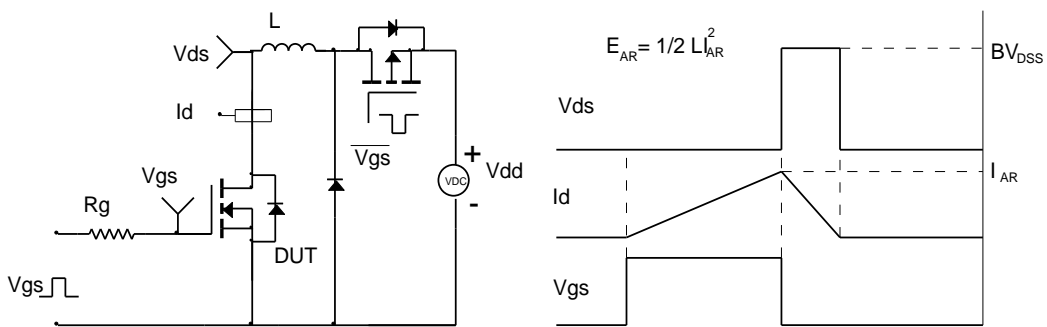

Diode Recovery Test Circuit & Waveforms

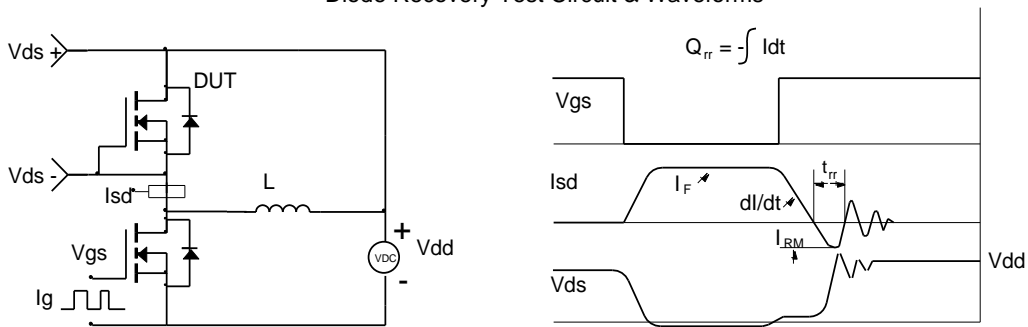

Package Outlines

Package Dimensions : PDFN 5*6 PACKAG

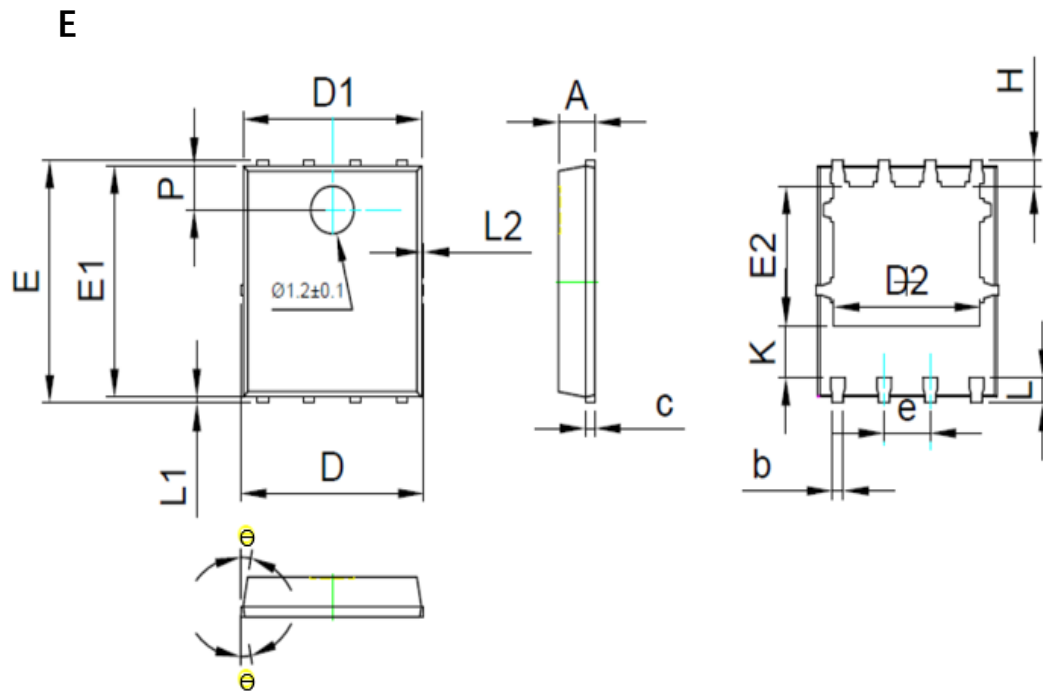

COMMON DIMENSIONS
(UNITS OF MEASURE = MILLIMETER)

SYMBOL	MIN	NOM	MAX
A	0.90	1.00	1.10
b	0.35	0.40	0.45
c	0.21	0.25	0.34
D	-	-	5.1
D1	4.85	4.90	4.95
D2	3.96	4.01	4.06
e	1.27 BSC		
E	5.95	6.00	6.05
E1	5.70	5.75	5.80
E2	3.425	3.475	3.525
H	0.60	0.65	0.70
K	1.29	-	-
L	0.60	0.65	0.70
L1	0.05	0.15	0.25
L2	-	-	0.12
θ	8°	10°	12°
P	1.05	1.10	1.15

Marking Information

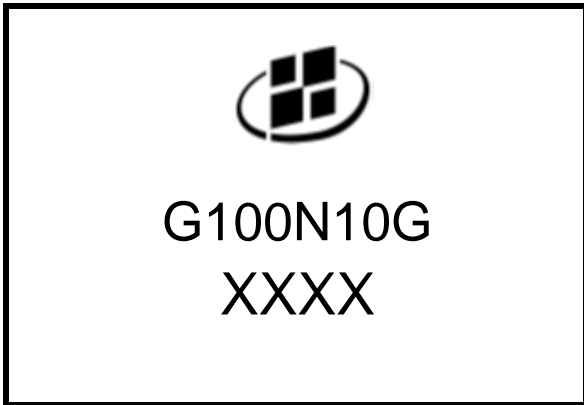

Note:
 G100N10G = Product Name Code
 XXXX = Date code
 Contact ALKAIDSEMI sales for detail information

REEL DIMENSIONS

TAPE DIMENSIONS

A0: Dimension designed to accommodate the component width
 B0: Dimension designed to accommodate the component length
 K0: Dimension designed to accommodate the component thickness
 W: Overall width of the carrier tape
 P0: Pitch between successive cavity centers and sprocket hole
 P1: Pitch between successive cavity centers
 P2: Pitch between sprocket hole
 T: Tape material thickness
 D1: Reel Diameter
 W1: Reel Width

DIMENSIONS										(Unit: mm)	
Reel	D1	W1								Material	
	330	12.5								Hips	
Tape	P0	P1	P2	W	A0	B0	K0	T	Pin 1 Quadrant	Material	
	4	8	2	12	6.3	5.3	1.2	0.25	Q1	PC	

All dimensions are nominal

Revision History

Revision	Release Date	Remark
Rev.1.0	2022/7/7	Initial Release

Disclaimer

The information given in this document describes the independent performance of the product, but similar performance is not guaranteed under other working conditions, and cannot be guaranteed when installed with other products or equipment. To achieve the required performance of the product in actual scenarios, the customer should conduct a complete application test to assess the functionality of the product.

Alkaidsemi assumes no responsibility for equipment failures result from using products at values that exceed the ratings, operating conditions, or other parameters listed in the product specifications.

The product described in this specification is not applicable for aerospace or other applications which requires high reliability. Customers using or selling these products for use in medical, life-saving, or life-sustaining applications do so at their own risk and agree to fully indemnify.

Due to product or technical improvements, the information described or contained herein may be changed without prior notice.