

100V 10mohm N-channel SGT MOSFET

AKG10N100PM

Description:

This N channel SGT MOSFET has been designed to very low on-state resistance and superior UIS performance, especially for Motor Drivers application.

Features:

- LOW $R_{DS(ON)}$
- RoHS compliant (Note 1)
- Halogen-free (Note 1)
- 100% UIS tested

Applications:

- Battery Management System
- Motor Drivers
- DC-DC Converter

Key Performance Parameters:

Parameter	Value	Unit
V_{DS}	100	V
$R_{DS(ON), max} @ V_{GS} = 10V$	10	m Ω
I_D	70	A

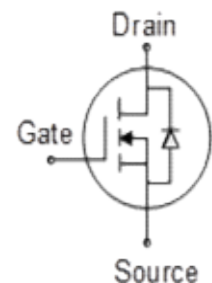
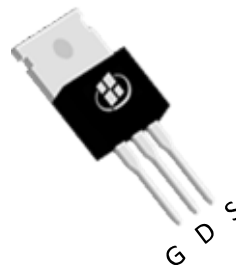

Ordering Information:

Ordering Code	Package Type	Marking Code	Form	Packing
AKG10N100PM	TO-220	G10N100PM	Tube	1000PCS

Notes:

1. Contact ALKAIDSEMI sales for detail information

Maximum Ratings ($T_A = 25^\circ\text{C}$ unless otherwise noted)

Symbol	Parameter	Value	Units
V_{DS}	Drain-Source Voltage	100	V
I_D	Drain Current - Continuous ($T_C = 25^\circ\text{C}$) ^(Note 1)	85	A
	Drain Current - Continuous ($T_C = 25^\circ\text{C}$) ^(Note 2)	70	A
	Drain Current - Continuous ($T_C = 100^\circ\text{C}$)	54	A
I_{DM}	Drain Current - Pulsed ^(Note 3)	280	A
V_{GS}	Gate-Source Voltage	± 20	V
E_{AS}	Single Pulsed Avalanche Energy ^(Note 4)	95	mJ
P_D	Power Dissipation ($T_C = 25^\circ\text{C}$)	138	W
T_J, T_{STG}	Operating and Storage Temperature Range	-55 to +150	$^\circ\text{C}$

Thermal Characteristics

Symbol	Parameter	Value	Units
$R_{\theta JC}$	Thermal Resistance, Junction-to-Case, Steady-State	0.9	$^\circ\text{C/W}$
$R_{\theta JA}$	Thermal Resistance, Junction-to-Ambient, Steady State ^(Note 5)	50	$^\circ\text{C/W}$

Notes:

1. The max drain current rating is silicon limited
2. The max drain current rating is package limited
3. Repetitive Rating: Pulse width limited by maximum junction temperature
4. $L = 0.5\text{ mH}$, $V_{DD} = 50\text{ V}$, $I_{AS} = 19.5\text{ A}$, $R_G = 25\ \Omega$, Starting $T_J = 25\ ^\circ\text{C}$
5. Mount on minimum PCB layout

Electrical Characteristics ($T_J = 25^\circ\text{C}$ unless otherwise noted)						
Symbol	Parameter	Test Conditions	Min	Typ	Max	Units
Static Characteristics						
BV_{DSS}	Drain-Source Breakdown Voltage	$V_{GS} = 0\text{ V}, I_D = 250\ \mu\text{A}$	100			V
I_{DSS}	Zero Gate Voltage Drain Current	$V_{DS} = 100\text{ V}, V_{GS} = 0\text{ V}$			1	μA
I_{GSS}	Gate Leakage Current	$V_{GS} = \pm 20\text{ V}, V_{DS} = 0\text{ V}$			± 100	nA
$V_{GS(TH)}$	Gate Threshold voltage	$V_{DS} = V_{GS}, I_D = 250\ \mu\text{A}$	2	3	4	V
$R_{DS(ON)}$	Drain-Source on-state resistance	$V_{GS} = 10\text{ V}, I_D = 20\text{ A}$		8.5	10	m Ω
Dynamic Characteristics						
C_{ISS}	Input Capacitance	$V_{DS} = 50\text{ V}, V_{GS} = 0\text{ V},$ $F = 1\text{ MHz}$		1611		pF
C_{OSS}	Output Capacitance			549		pF
C_{RSS}	Reverse Transfer Capacitance			30		pF
R_G	Gate Resistance	$F = 1\text{ MHz}$		1.6		Ω
Switching Characteristics						
$T_{D(ON)}$	Turn On Delay Time	$V_{DD} = 50\text{ V}, R_L = 2.5\ \Omega,$ $V_{GS} = 10\text{ V}, R_G = 6.8\ \Omega$		12		nS
T_R	Rise Time			22		nS
$T_{D(OFF)}$	Turn Off Delay Time			24		nS
T_F	Fall Time			14		nS
Q_G	Total Gate Charge	$V_{DD} = 50\text{ V}, I_D = 20\text{ A},$ $V_{GS} = 10\text{ V}$		26.3		nC
Q_{GS}	Gate-Source Charge			6.6		nC
Q_{GD}	Gate-Drain Charge			8.5		nC
Drain-Source Diode Characteristics and Maximum Ratings						
I_S	Maximum Continuous Body-Diode Forward Current				70	A
I_{SM}	Maximum Pulsed Body-Diode Forward Current ^(NOTE 1)				280	A
V_{SD}	Diode Forward Voltage	$V_{GS} = 0\text{ V}, I_S = 1\text{ A}$		0.75	1	V
T_{RR}	Reverse Recovery Time	$V_{DD} = 50\text{ V}, I_D = 20\text{ A},$ $di/dt = 100\text{ A}/\mu\text{S}$		52		nS
Q_{RR}	Reverse Recovery Charge			72		nC
I_{RRM}	Peak Reverse Recovery Current			2.3		A

Electrical Characteristics Diagrams

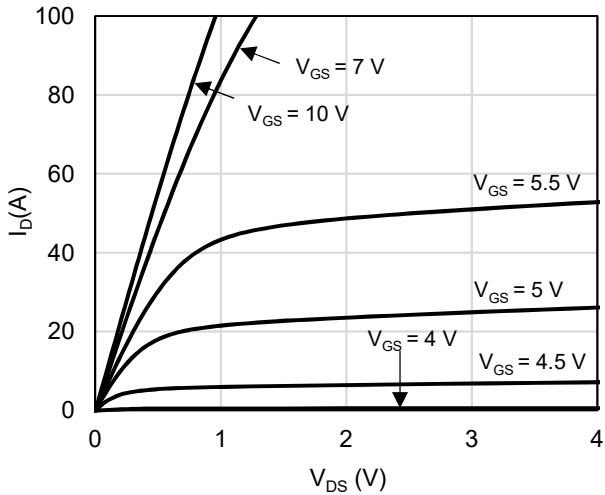

Figure 1: On-Region Characteristics

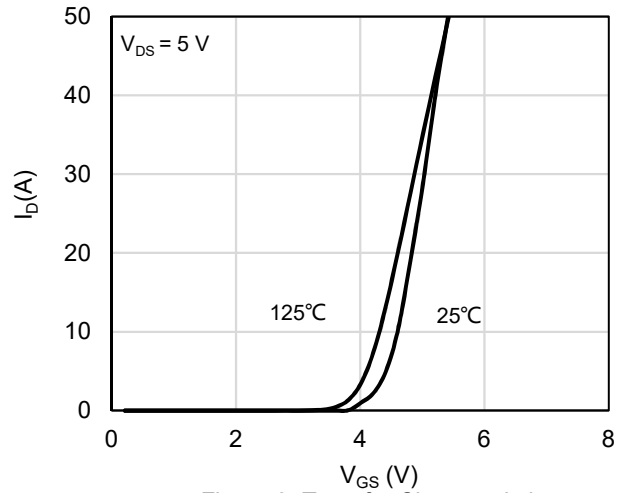

Figure 2: Transfer Characteristics

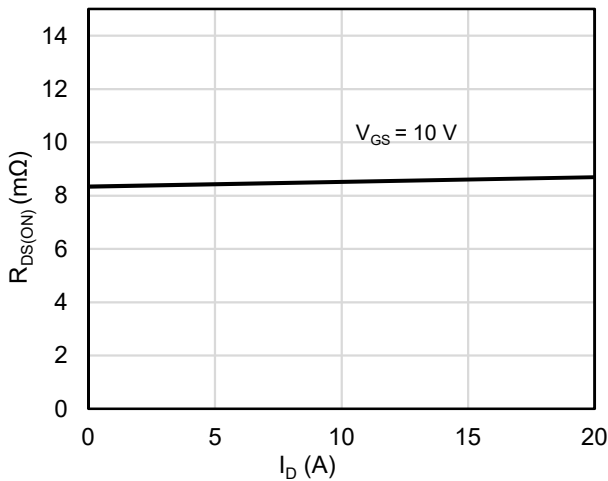

Figure 3: On-Resistance vs. Drain Current and Gate Voltage

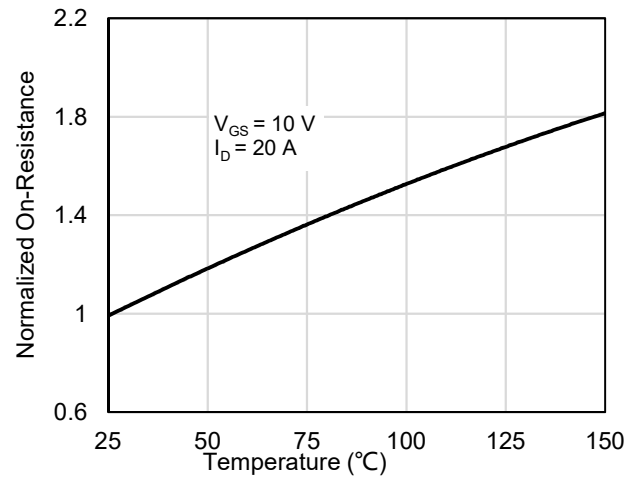

Figure 4: On-Resistance vs. Junction Temperature

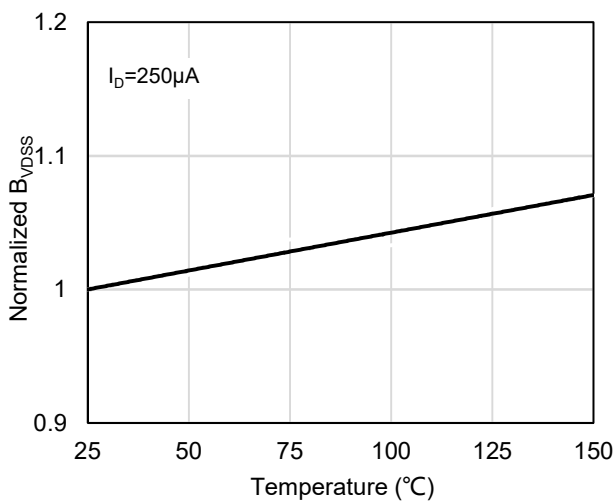

Figure 5: Breakdown Voltage vs. Junction Temperature

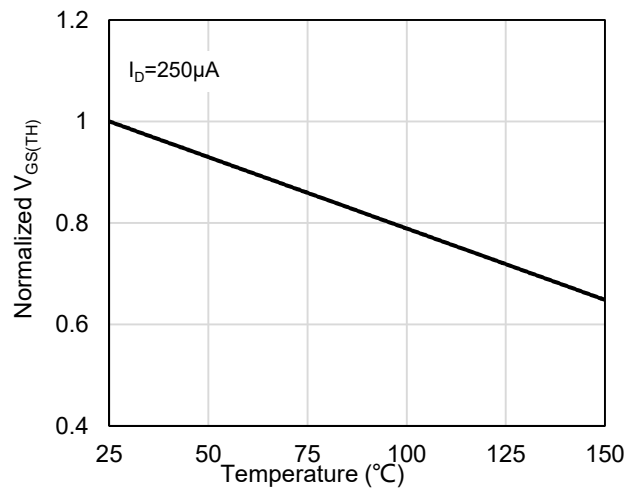

Figure 6: Threshold Voltage vs. Junction Temperature

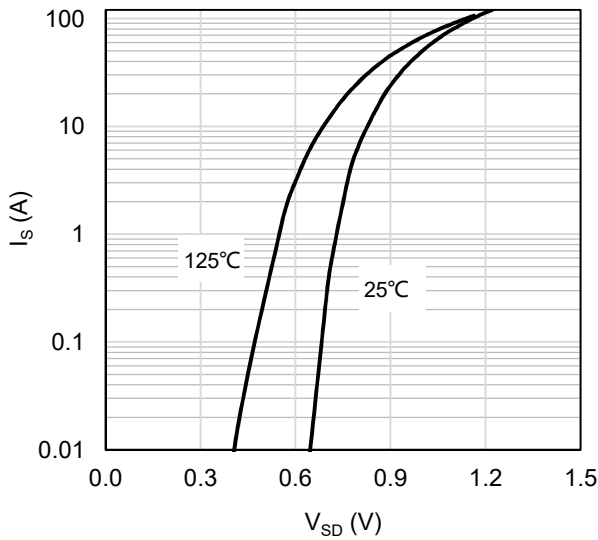

Figure 7: Body-Diode Characteristics

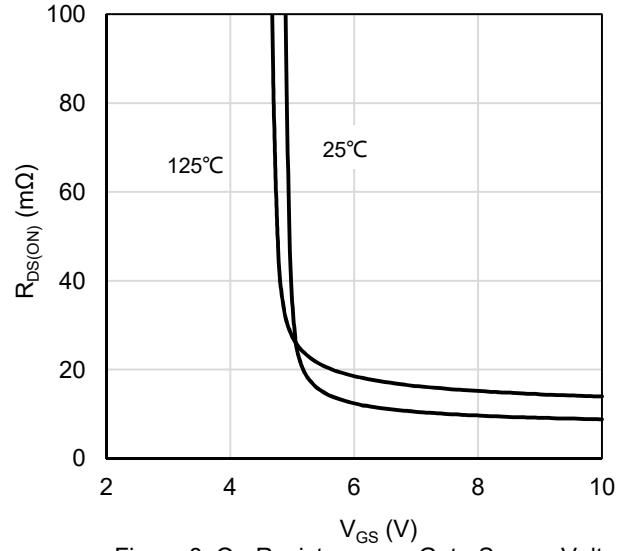

Figure 8: On-Resistance vs. Gate-Source Voltage

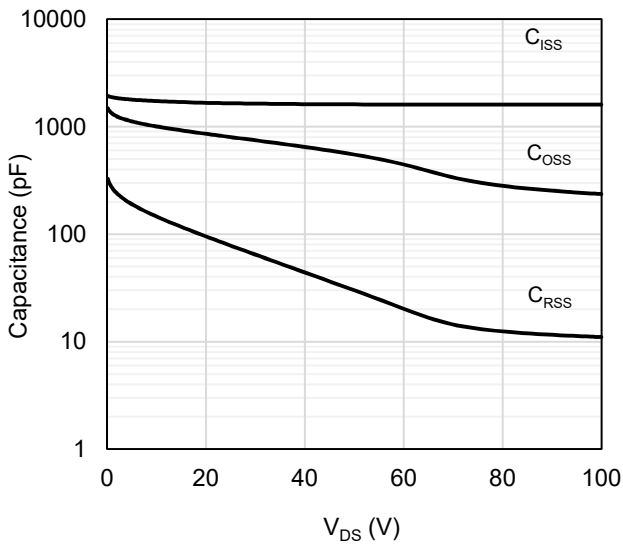

Figure 9: Capacitance Characteristics

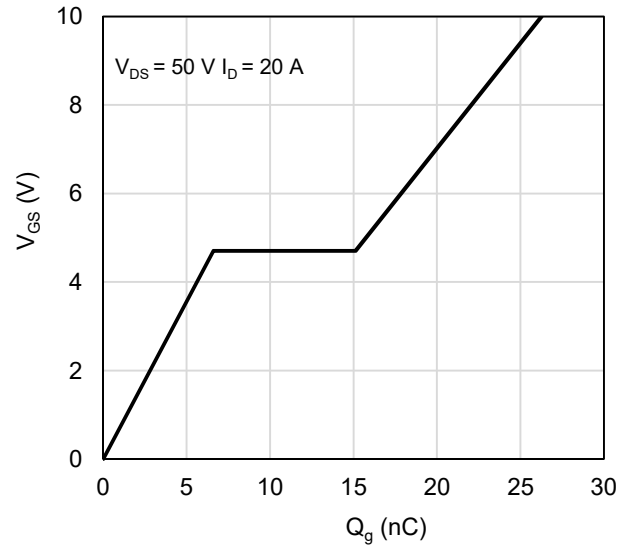

Figure 10: Gate-Charge Characteristics

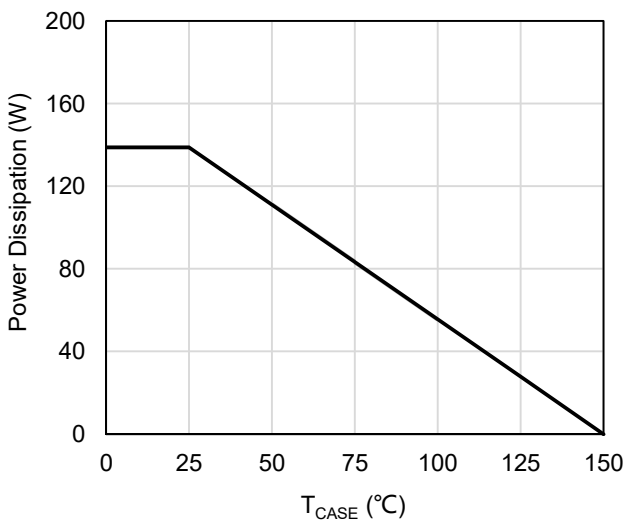

Figure 11: Power De-rating

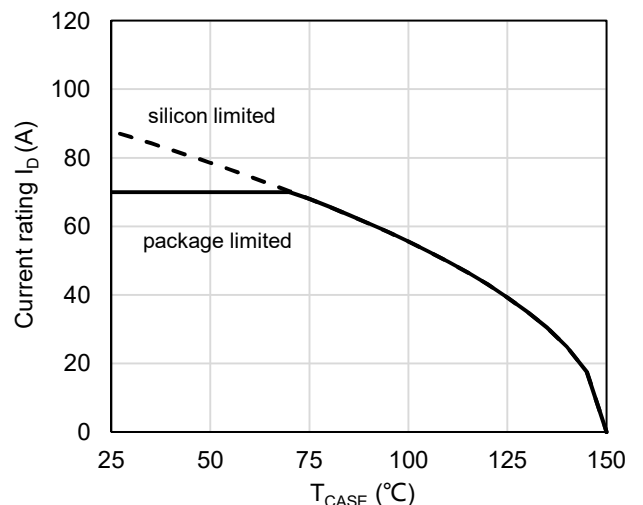

Figure 12: Current De-rating

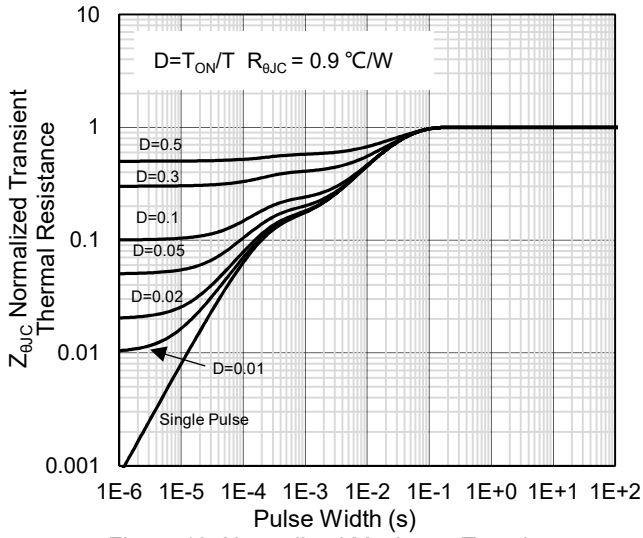

Figure 13: Normalized Maximum Transient Thermal Impedance

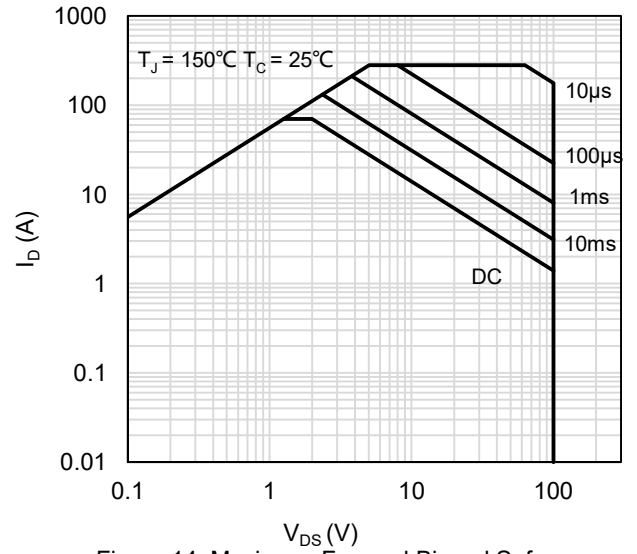
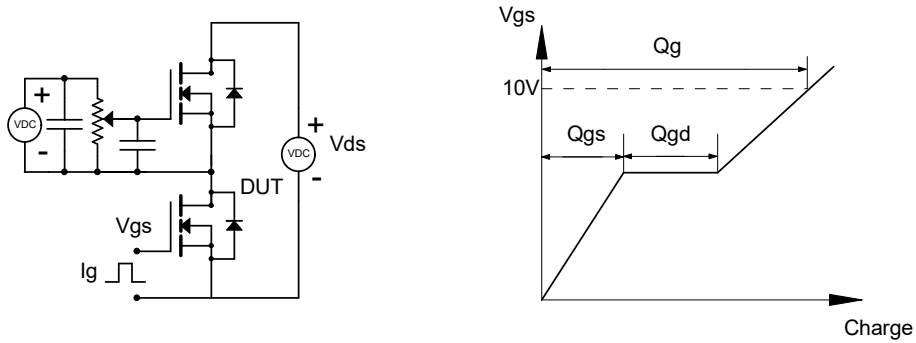

Figure 14: Maximum Forward Biased Safe Operating Area

Test Circuit and Waveform

Gate Charge Test Circuit & Waveform



Resistive Switching Test Circuit & Waveforms

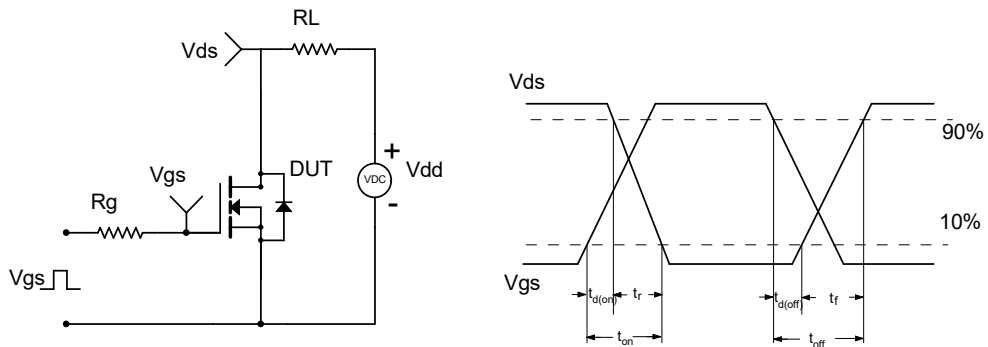

Unclamped Inductive Switching (UIS) Test Circuit & Waveforms

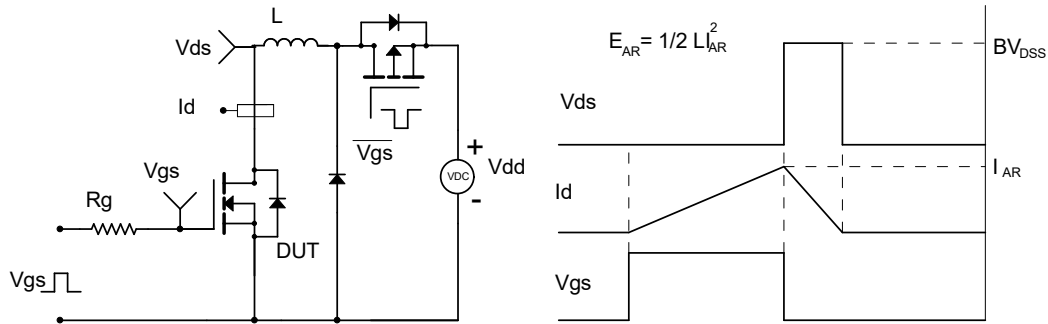

Diode Recovery Test Circuit & Waveforms

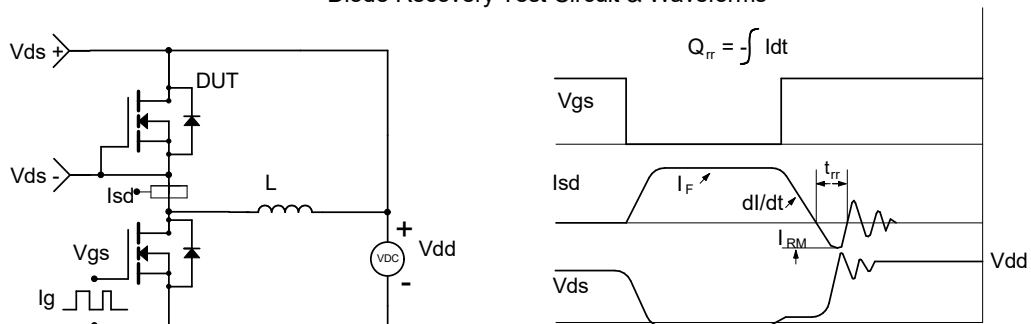

Package Outlines

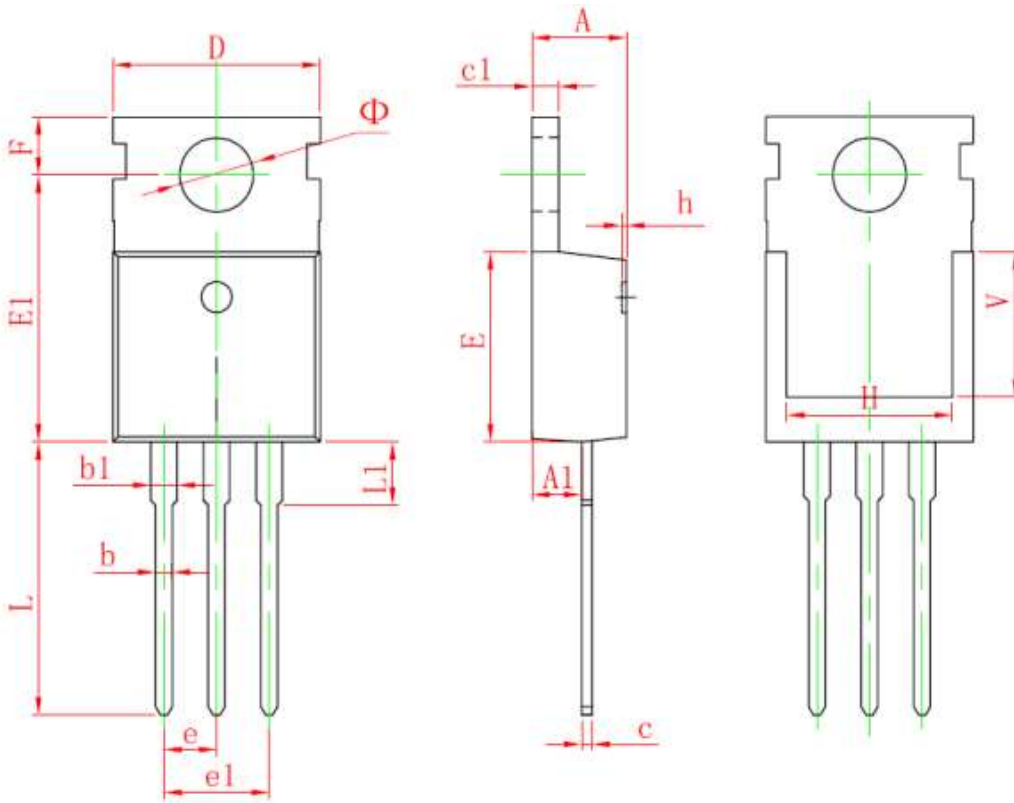

Symbol	Dimensions In Millimeters		Dimensions In Inches	
	Min.	Max.	Min.	Max.
A	4.400	4.600	0.173	0.181
A1	2.250	2.550	0.089	0.100
b	0.710	0.910	0.028	0.036
b1	1.170	1.370	0.046	0.054
c	0.330	0.650	0.013	0.026
c1	1.200	1.400	0.047	0.055
D	9.910	10.250	0.390	0.404
E	8.950	9.750	0.352	0.384
E1	12.650	13.050	0.498	0.514
e	2.540 TYP.		0.100 TYP.	
e1	4.980	5.180	0.196	0.204
F	2.650	2.950	0.104	0.116
H	7.900	8.100	0.311	0.319
h	0.000	0.300	0.000	0.012
L	12.900	13.400	0.508	0.528
L1	2.850	3.250	0.112	0.128
V	6.900 REF.		0.276 REF.	
Φ	3.400	3.800	0.134	0.150

Marking Information



G10N100PM
XXXXXXXX

Note:

G10N100PM = Product Name Code

XXXXXXXX = Date code

Contact ALKAIDSEMI sales for detail information

Revision History

Revision	Release Date	Remark
Rev.1.0	2022/12/9	Initial Release

Disclaimer

The information given in this document describes the independent performance of the product, but similar performance is not guaranteed under other working conditions, and cannot be guaranteed when installed with other products or equipment. To achieve the required performance of the product in actual scenarios, the customer should conduct a complete application test to assess the functionality of the product.

Alkaidsemi assumes no responsibility for equipment failures result from using products at values that exceed the ratings, operating conditions, or other parameters listed in the product specifications.

The product described in this specification is not applicable for aerospace or other applications which requires high reliability. Customers using or selling these products for use in medical, life-saving, or life-sustaining applications do so at their own risk and agree to fully indemnify.

Due to product or technical improvements, the information described or contained herein may be changed without prior notice.