

150V 9.9mohm N-channel SGT MOSFET

AKG15N099GM

Description:

This N channel SGT MOSFET has been designed to very low on-state resistance and superior UIS performance, especially for Motor Drivers application.

Features:

- LOW $R_{DS(ON)}$
- RoHS compliant ^(Note 1)
- Halogen-free ^(Note 1)
- 100% UIS tested

Applications:

- Battery Management System
- Motor Drivers
- DC-DC Converter

Key Performance Parameters:

Parameter	Value	Unit
V_{DS}	150	V
$R_{DS(ON), max} @ V_{GS} = 10 V$	9.9	m Ω
I_D	65	A

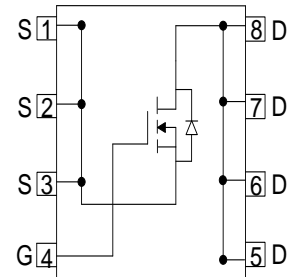
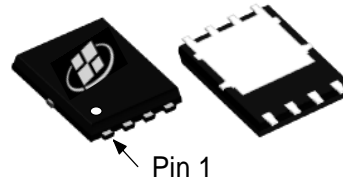

Ordering Information:

Ordering Code	Package Type	Marking Code	Form	Packing
AKG15N099GM	PDFN5X6	G15N099GM	Tape Reel	5000PCS

Notes:

1. Contact ALKAIDSEMI sales for detail information

Maximum Ratings ($T_A = 25^\circ\text{C}$ unless otherwise noted)

Symbol	Parameter	Value	Units
V_{DS}	Drain-Source Voltage	150	V
I_D	Drain Current - Continuous ($T_C = 25^\circ\text{C}$) ^(Note 1)	65	A
	Drain Current - Continuous ($T_C = 100^\circ\text{C}$)	41	A
I_{DM}	Drain Current - Pulsed ^(Note 2)	260	A
V_{GS}	Gate-Source Voltage	± 20	V
E_{AS}	Single Pulsed Avalanche Energy ^(Note 3)	324	mJ
P_D	Power Dissipation ($T_C = 25^\circ\text{C}$)	104	W
T_J, T_{STG}	Operating and Storage Temperature Range	-55 to +150	$^\circ\text{C}$

Thermal Characteristics

Symbol	Parameter	Value	Units
$R_{\theta JC}$	Thermal Resistance, Junction-to-Case, Steady-State	1.2	$^\circ\text{C/W}$
$R_{\theta JA}$	Thermal Resistance, Junction-to-Ambient, Steady State ^(Note 4)	45	$^\circ\text{C/W}$

Notes:

1. The max drain current rating is silicon limited
2. Repetitive Rating: Pulse width limited by maximum junction temperature
3. $L = 0.5 \text{ mH}$, $V_{DD} = 50 \text{ V}$, $I_{AS} = 36 \text{ A}$, $R_G = 25 \Omega$, Starting $T_J = 25 \text{ }^\circ\text{C}$
4. Mount on minimum PCB layout

Electrical Characteristics ($T_J = 25^\circ\text{C}$ unless otherwise noted)						
Symbol	Parameter	Test Conditions	Min	Typ	Max	Units
Static Characteristics						
BV_{DSS}	Drain-Source Breakdown Voltage	$V_{GS} = 0\text{ V}, I_D = 250\ \mu\text{A}$	150			V
I_{DSS}	Zero Gate Voltage Drain Current	$V_{DS} = 150\text{ V}, V_{GS} = 0\text{ V}$			1	μA
I_{GSS}	Gate Leakage Current	$V_{GS} = \pm 20\text{ V}, V_{DS} = 0\text{ V}$			± 100	nA
$V_{GS(TH)}$	Gate Threshold voltage	$V_{DS} = V_{GS}, I_D = 250\ \mu\text{A}$	2	3	4	V
$R_{DS(ON)}$	Drain-Source on-state resistance	$V_{GS} = 10\text{ V}, I_D = 20\text{ A}$		8	9.9	m Ω
Dynamic Characteristics						
C_{ISS}	Input Capacitance	$V_{DS} = 75\text{ V}, V_{GS} = 0\text{ V},$ $F = 1\text{ MHz}$		3690		pF
C_{OSS}	Output Capacitance			320		pF
C_{RSS}	Reverse Transfer Capacitance			15		pF
R_G	Gate Resistance	$F = 1\text{ MHz}$		1.2		Ω
Switching Characteristics						
$T_{D(ON)}$	Turn On Delay Time	$V_{DD} = 75\text{ V}, R_L = 3.8\ \Omega,$ $V_{GS} = 10\text{ V}, R_G = 6.8\ \Omega$		23		nS
T_R	Rise Time			40		nS
$T_{D(OFF)}$	Turn Off Delay Time			48		nS
T_F	Fall Time			22		nS
Q_G	Total Gate Charge	$V_{DD} = 75\text{ V}, I_D = 20\text{ A},$ $V_{GS} = 10\text{ V}$		51		nC
Q_{GS}	Gate-Source Charge			18		nC
Q_{GD}	Gate-Drain Charge			10		nC
Drain-Source Diode Characteristics and Maximum Ratings						
I_S	Maximum Continuous Body-Diode Forward Current				65	A
I_{SM}	Maximum Pulsed Body-Diode Forward Current ^(NOTE 1)				260	A
V_{SD}	Diode Forward Voltage	$V_{GS} = 0\text{ V}, I_S = 1\text{ A}$		0.68		V
T_{RR}	Reverse Recovery Time	$V_{DD} = 75\text{ V}, I_D = 20\text{ A},$ $di/dt = 100\text{ A}/\mu\text{S}$		86		nS
Q_{RR}	Reverse Recovery Charge			265		nC
I_{RRM}	Peak Reverse Recovery Current			5		A

Electrical Characteristics Diagrams

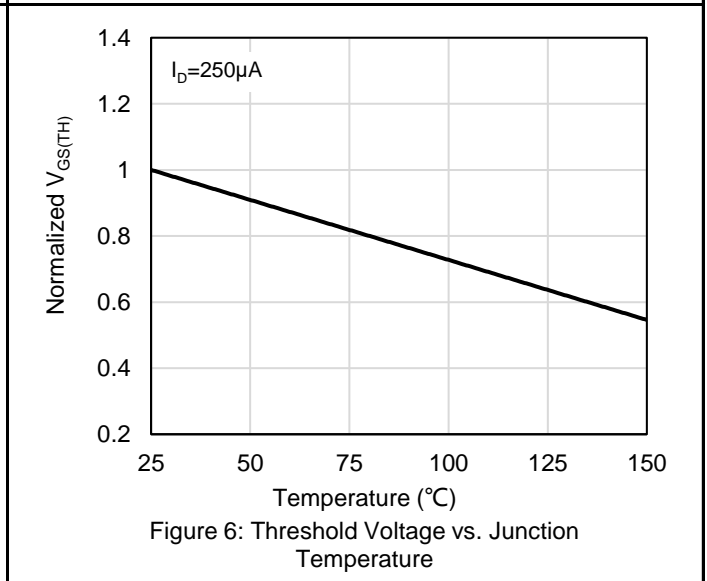
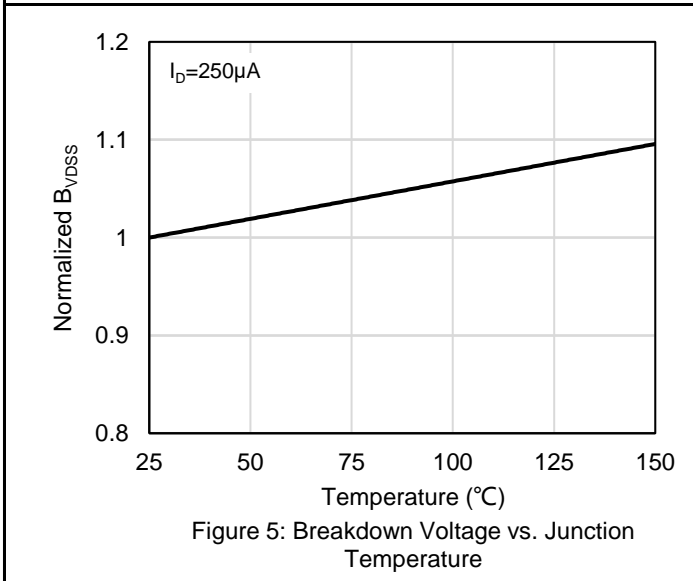
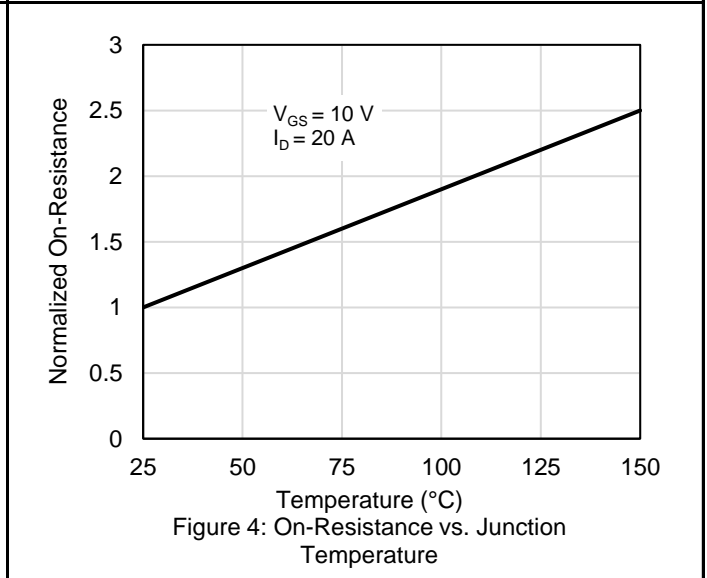
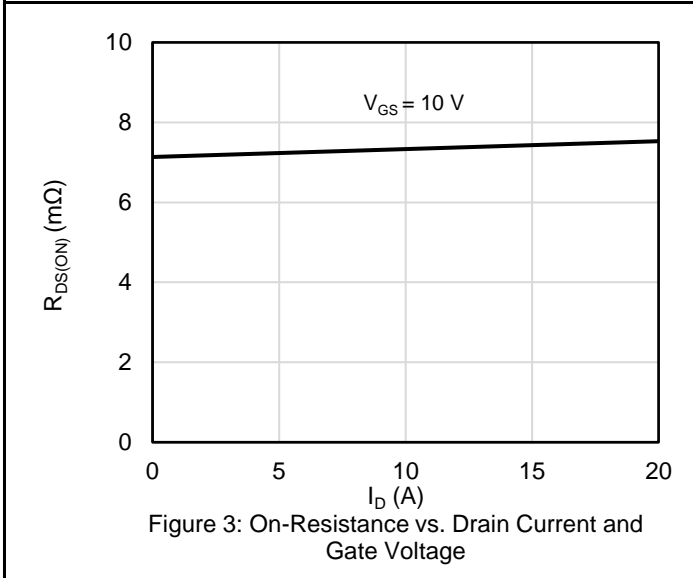
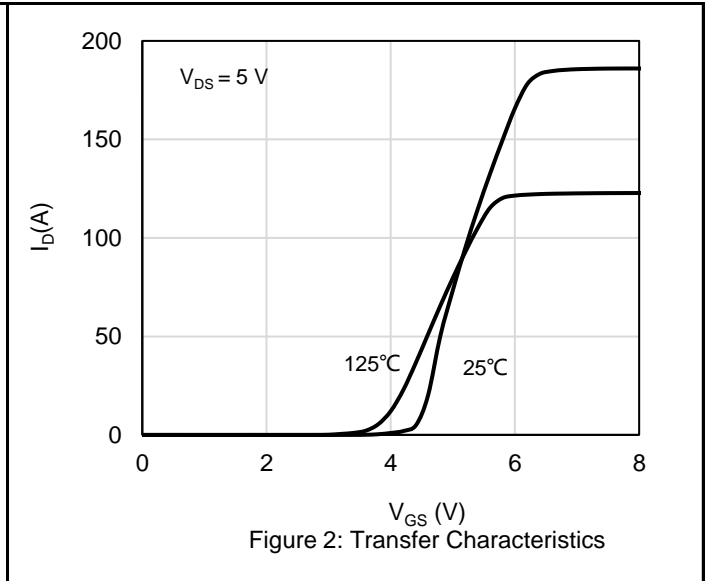
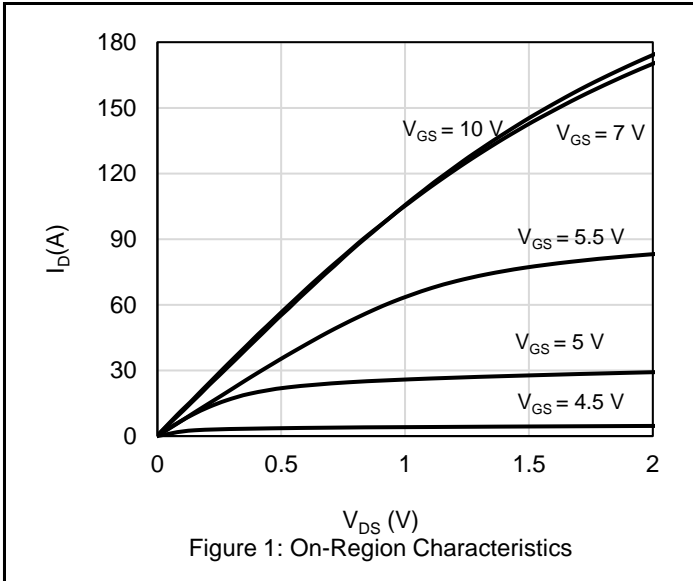

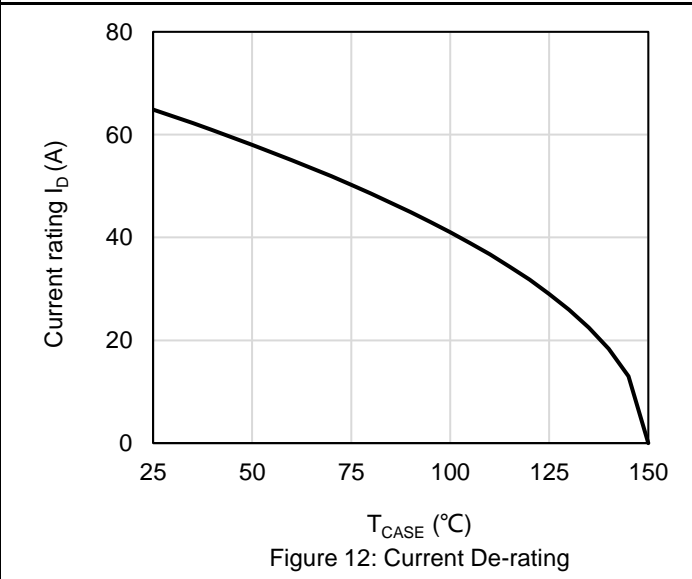
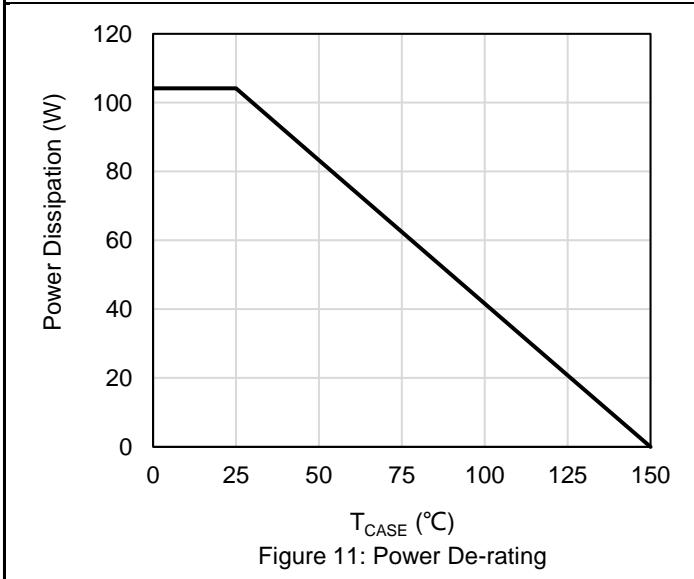
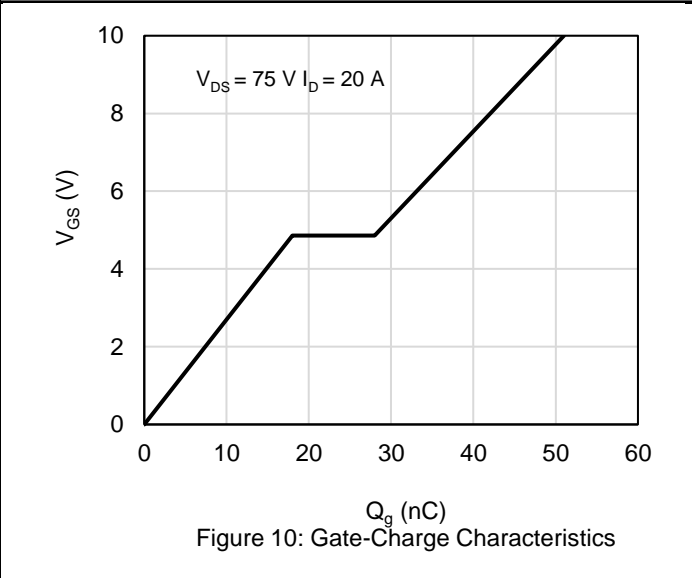
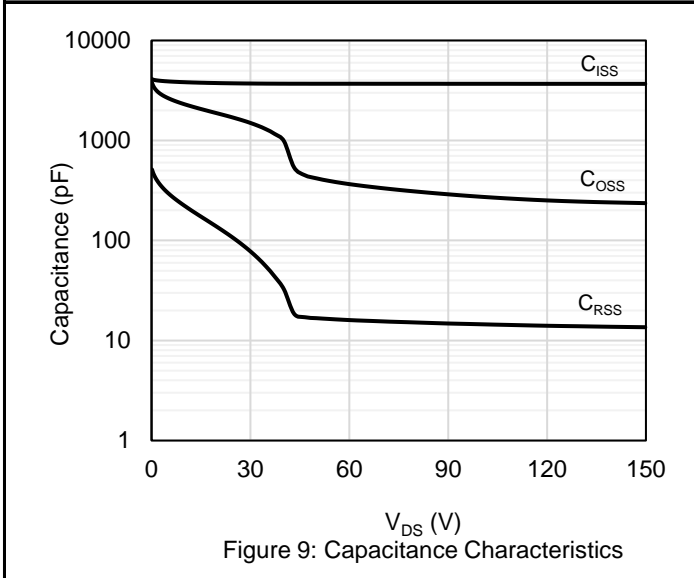
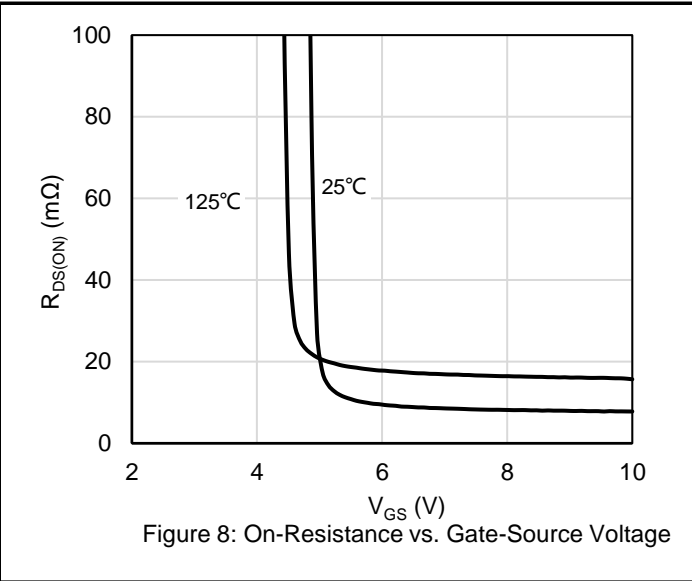
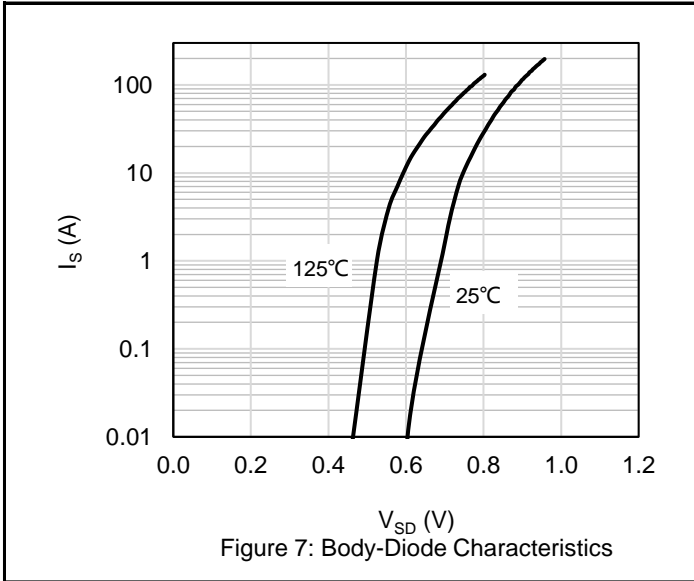

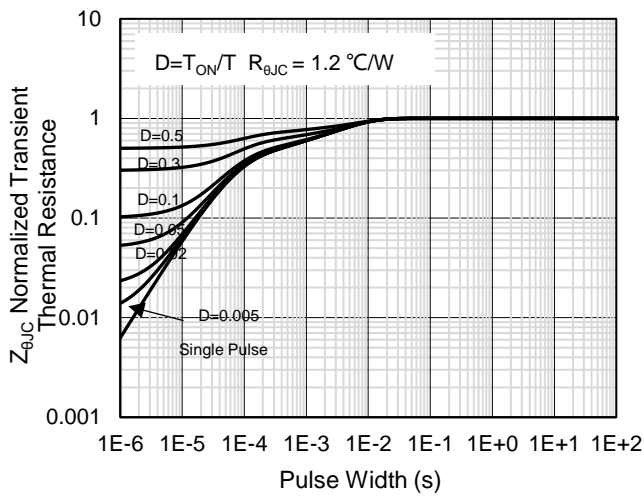

Figure 13: Normalized Maximum Transient Thermal Impedance

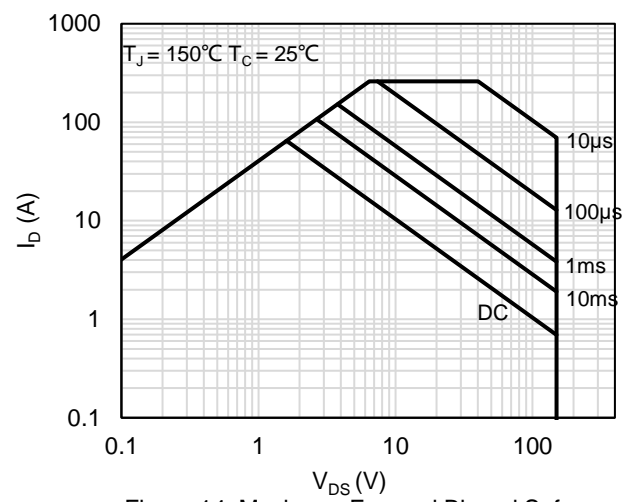
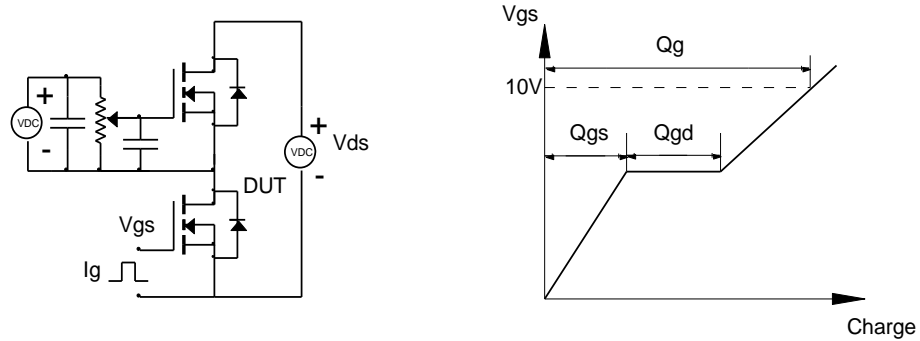

Figure 14: Maximum Forward Biased Safe Operating Area

Test Circuit and Waveform

Gate Charge Test Circuit & Waveform



Resistive Switching Test Circuit & Waveforms

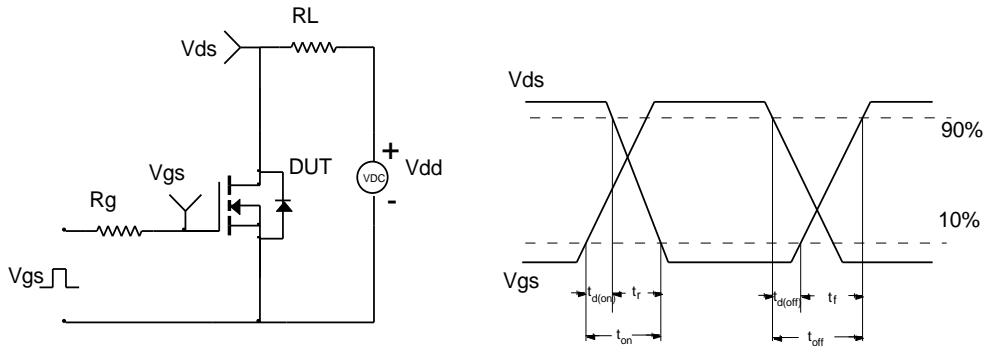

Unclamped Inductive Switching (UIS) Test Circuit & Waveforms

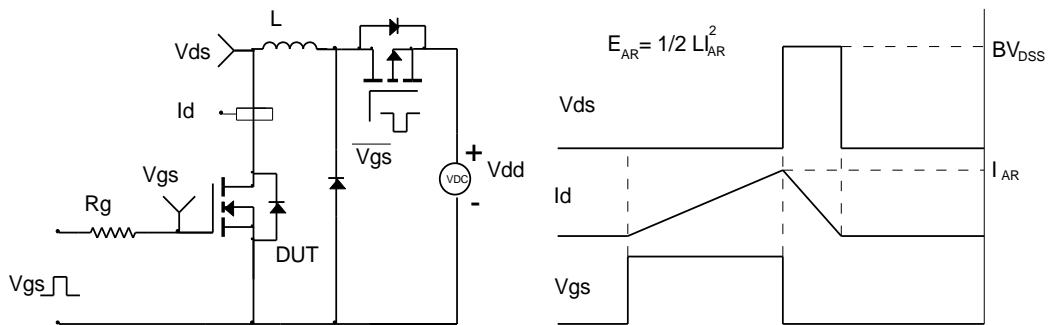

Diode Recovery Test Circuit & Waveforms

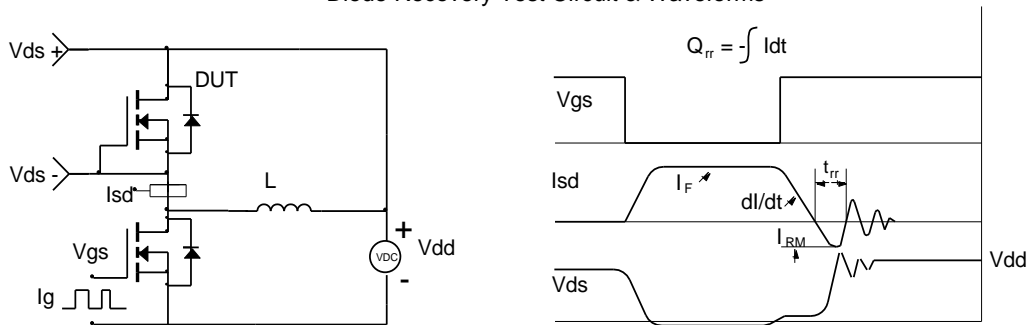

Package Outlines

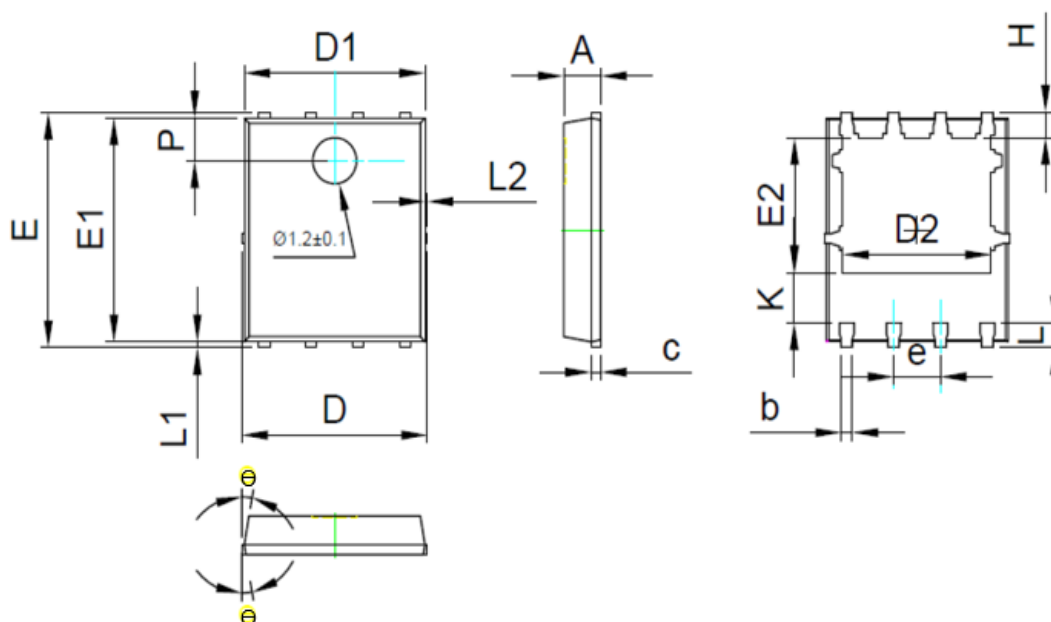

COMMON DIMENSIONS
(UNITS OF MEASURE = MILLIMETER)

SYMBOL	MIN	NOM	MAX
A	0.90	1.00	1.10
b	0.35	0.40	0.45
c	0.21	0.25	0.34
D	-	-	5.1
D1	4.85	4.90	4.95
D2	3.96	4.01	4.06
e	1.27 BSC		
E	5.95	6.00	6.05
E1	5.70	5.75	5.80
E2	3.425	3.475	3.525
H	0.60	0.65	0.70
K	1.29	-	-
L	0.60	0.65	0.70
L1	0.05	0.15	0.25
L2	-	-	0.12
θ	8°	10°	12°
P	1.05	1.10	1.15

Marking Information

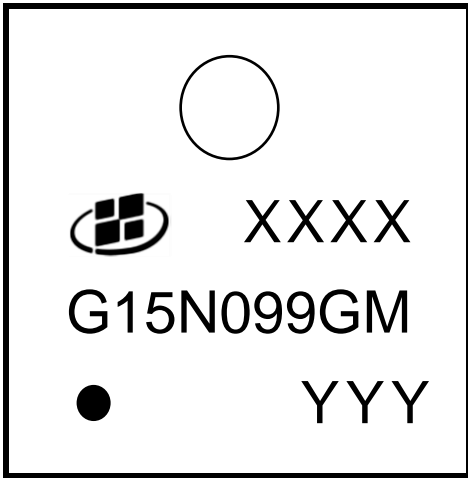

Note:
 G15N099GM = Product Name Code
 XXXX = Date code
 YYY
 Contact ALKAIDSEMI sales for detail information

Reel Information

REEL DIMENSIONS

TAPE DIMENSIONS

A0: Dimension designed to accommodate the component width
 B0: Dimension designed to accommodate the component length
 K0: Dimension designed to accommodate the component thickness
 W: Overall width of the carrier tape
 P0: Pitch between successive cavity centers and sprocket hole
 P1: Pitch between successive cavity centers
 P2: Pitch between sprocket hole
 T: Tape material thickness
 D1: Reel Diameter
 W1: Reel Width

DIMENSIONS										(Unit: mm)
Reel	D1	W1								Material
	330	12.5								Hips
Tape	P0	P1	P2	W	A0	B0	K0	T	Pin 1 Quadrant	Material
	4	8	2	12	6.3	5.3	1.2	0.25	Q1	PC

All dimensions are nominal

Revision History

Revision	Release Date	Remark
Rev.1.0	2022/7/13	Initial Release

Disclaimer

The information given in this document describes the independent performance of the product, but similar performance is not guaranteed under other working conditions, and cannot be guaranteed when installed with other products or equipment. To achieve the required performance of the product in actual scenarios, the customer should conduct a complete application test to assess the functionality of the product.

Alkaidsemi assumes no responsibility for equipment failures result from using products at values that exceed the ratings, operating conditions, or other parameters listed in the product specifications.

The product described in this specification is not applicable for aerospace or other applications which requires high reliability. Customers using or selling these products for use in medical, life-saving, or life-sustaining applications do so at their own risk and agree to fully indemnify.

Due to product or technical improvements, the information described or contained herein may be changed without prior notice.