

40V 1.8mohm SGT Power MOSFET

AKG40N018G

Description:

This N channel SGT MOSFET has been designed to very low on-state resistance ($R_{DS(ON)}$) and yet maintain superior switching performance, especially for high efficiency power management applications

Features:

- N-channel, optimized for high-speed smooth switching
- Excellent Gate Charge $\times R_{DS(ON)}$ (FOM)
- Very low on-resistance
- RoHS compliant ^(Note 1)
- Halogen-free ^(Note 1)

Applications:

- DC-DC Converter
- Power Tools
- Load Switching

Key Performance Parameters:

Parameter	Value	Unit
V_{DS}	40	V
$R_{DS(ON), max}$ @ $V_{GS} = 10V$	1.8	m Ω
I_D	130	A

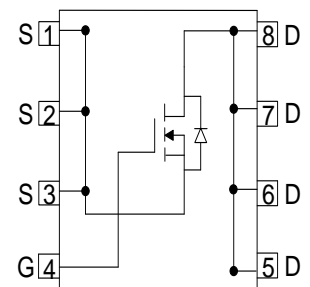
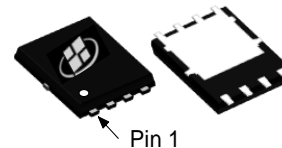

Ordering Information:

Ordering Code	Package Type	Marking Code	Form	Packing
AKG40N018G	PDFN5X6	AKG40N018G	Tape Reel	5000 per reel

Notes:

1. Contact ALKAIDSEMI sales for detail information

Maximum Ratings ($T_A = 25^\circ\text{C}$ unless otherwise noted)

Symbol	Parameter	Value	Units
V_{DS}	Drain-Source Voltage	40	V
I_D	Drain Current - Continuous ($T_C = 25^\circ\text{C}$) ^(Note 1)	130	A
	Drain Current - Continuous ($T_C = 100^\circ\text{C}$)	105	A
I_{DM}	Drain Current - Pulsed ^(Note 2)	400	A
V_{GS}	Gate-Source Voltage	± 20	V
E_{AS}	Single Pulsed Avalanche Energy ^(Note 3)	210	mJ
P_D	Power Dissipation ($T_C = 25^\circ\text{C}$)	89	W
T_J, T_{STG}	Operating and Storage Temperature Range	-55 to +150	$^\circ\text{C}$

Thermal Characteristics

Symbol	Parameter	Value	Units
$R_{\theta JC}$	Thermal Resistance, Junction-to-Case, Steady-State	1.4	$^\circ\text{C}/\text{W}$
$R_{\theta JA}$	Thermal Resistance, Junction-to-Ambient, Steady-State ^(Note 4)	50	$^\circ\text{C}/\text{W}$

Notes:

1. The max drain current rating is package limited
2. Repetitive Rating: Pulse width limited by maximum junction temperature
3. $L = 0.5 \text{ mH}$, $V_{DD} = 20\text{V}$, $I_{AS} = 29 \text{ A}$, $R_G = 50 \Omega$, Starting $T_J = 25^\circ\text{C}$
4. Mount on minimum PCB layout

Electrical Characteristics ($T_J = 25^\circ\text{C}$ unless otherwise noted)						
Symbol	Parameter	Test Conditions	Min	Typ	Max	Units
Static Characteristics						
BV_{DSS}	Drain-Source Breakdown Voltage	$V_{GS} = 0\text{ V}, I_D = 250\ \mu\text{A}$	40			V
I_{DSS}	Zero Gate Voltage Drain Current	$V_{DS} = 40\text{ V}, V_{GS} = 0\text{ V},$			1	μA
I_{GSS}	Gate Leakage Current	$V_{GS} = \pm 20\text{ V}, V_{DS} = 0\text{ V}$			± 100	nA
$V_{GS(TH)}$	Gate Threshold voltage	$V_{DS} = V_{GS}, I_D = 250\ \mu\text{A}$	1	1.8	2.5	V
$R_{DS(ON)}$	Drain-Source on-state resistance	$V_{GS} = 10\text{ V}, I_D = 20\text{ A}$		1.55	1.8	m Ω
		$V_{GS} = 4.5\text{ V}, I_D = 20\text{ A}$		2.3	3.3	
Dynamic Characteristics						
C_{ISS}	Input Capacitance	$V_{DS} = 20\text{ V}, V_{GS} = 0\text{ V},$ $F = 1\text{ MHz}$		2916		pF
C_{OSS}	Output Capacitance			966		pF
C_{RSS}	Reverse Transfer Capacitance			81		pF
R_G	Gate Resistance	$F = 1\text{ MHz}$		6.7		Ω
Switching Characteristics						
$T_{D(ON)}$	Turn On Delay Time	$V_{DD} = 15\text{ V}, I_D = 20\text{ A},$ $V_{GS} = 10\text{ V}, R_G = 3.3\ \Omega$		8.5		nS
T_R	Rise Time			46.5		nS
$T_{D(OFF)}$	Turn Off Delay Time			63.5		nS
T_F	Fall Time			39		nS
Q_G	Total Gate Charge	$V_{DD} = 15\text{ V}, I_D = 20\text{ A},$ $V_{GS} = 10\text{ V}$		40.5		nC
Q_{GS}	Gate-Source Charge			7.9		nC
Q_{GD}	Gate-Drain Charge			6.6		nC
Drain-Source Diode Characteristics and Maximum Ratings						
I_S	Maximum Continuous Body-Diode Forward Current				130	A
I_{SM}	Maximum Pulsed Body-Diode Forward Current ^(NOTE 2)				400	A
V_{SD}	Diode Forward Voltage	$V_{GS} = 0\text{ V}, I_S = 1\text{ A}$		0.7		V
T_{RR}	Reverse recovery time	$V_{DD} = 20\text{ V}, I_D = 20\text{ A},$ $di/dt = 100\text{ A}/\mu\text{s}$		39		ns
Q_{RR}	Reverse recovery charge			30		nC

Electrical Characteristics Diagrams

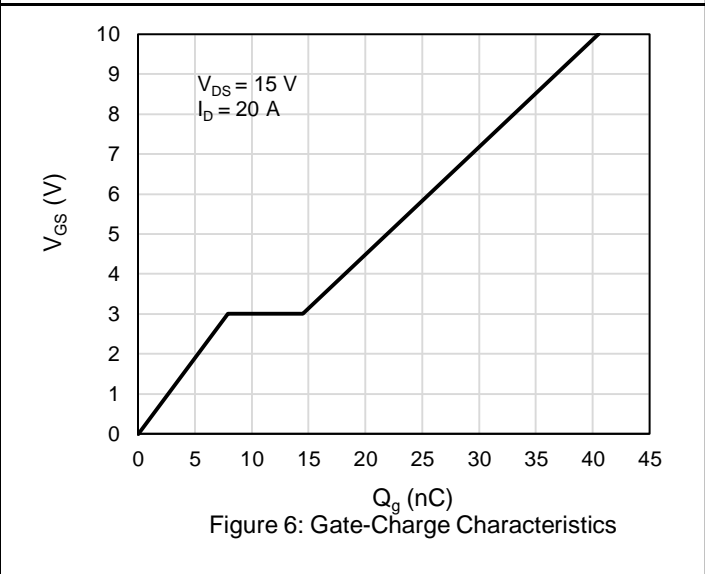
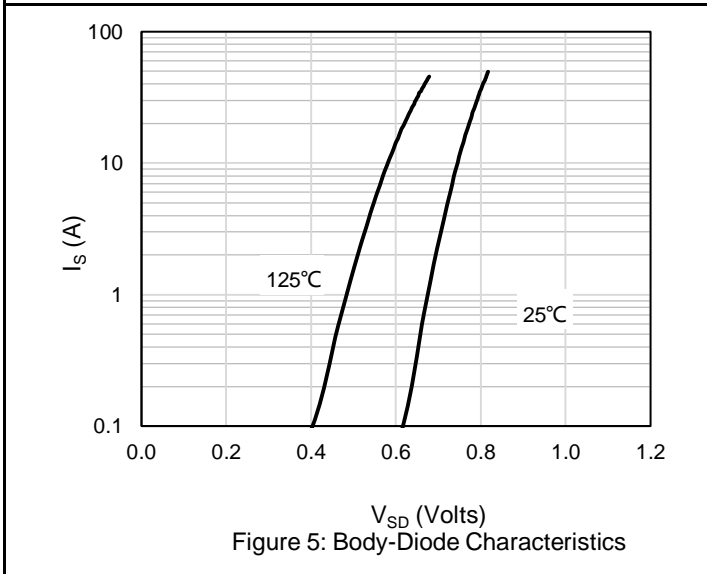
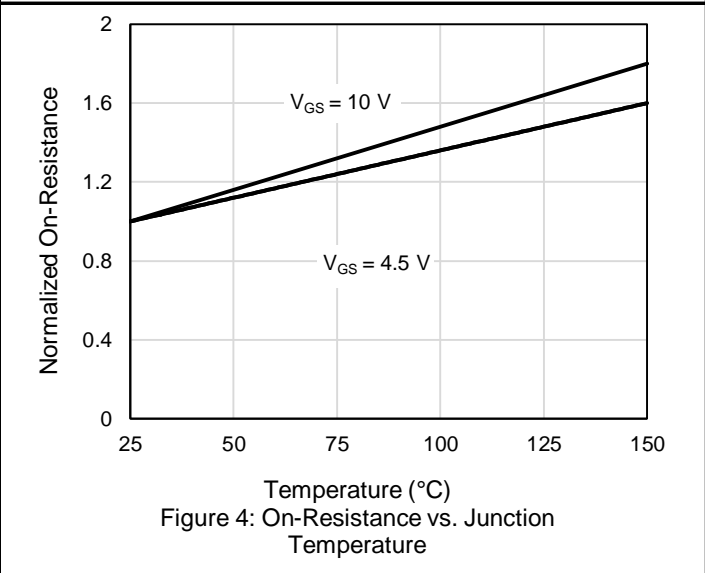
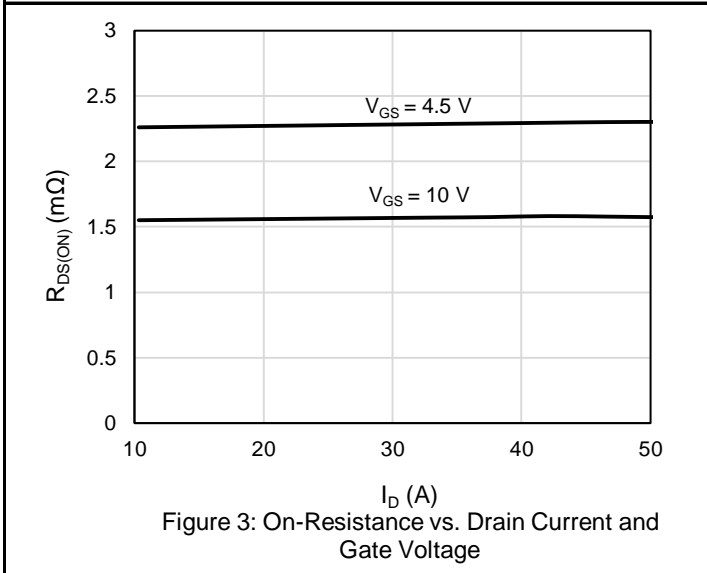
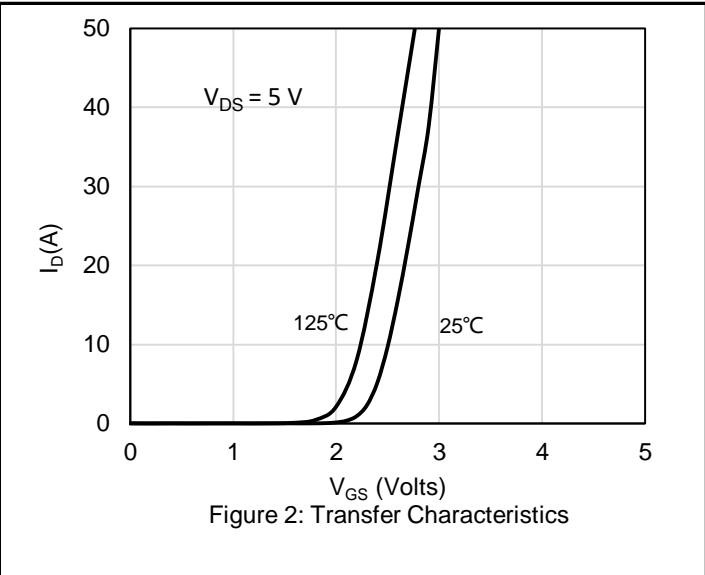
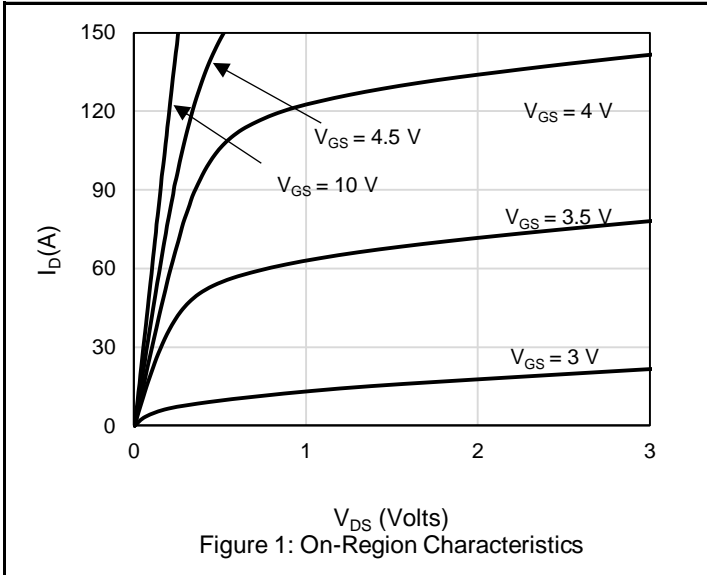

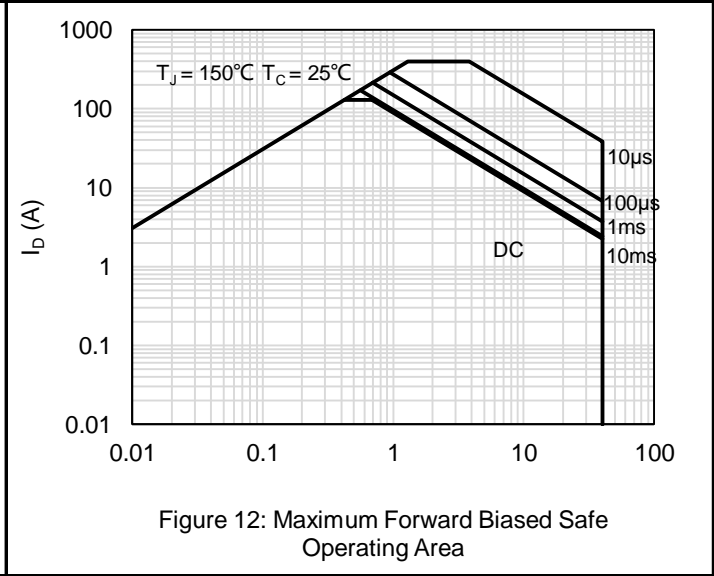
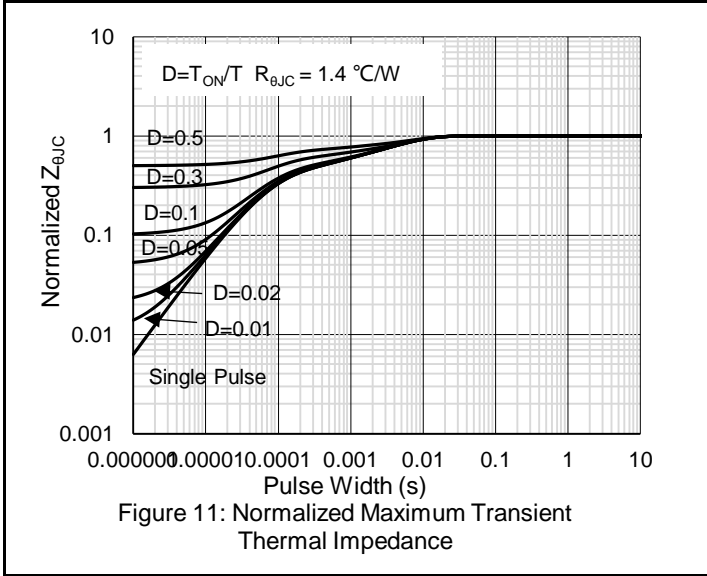
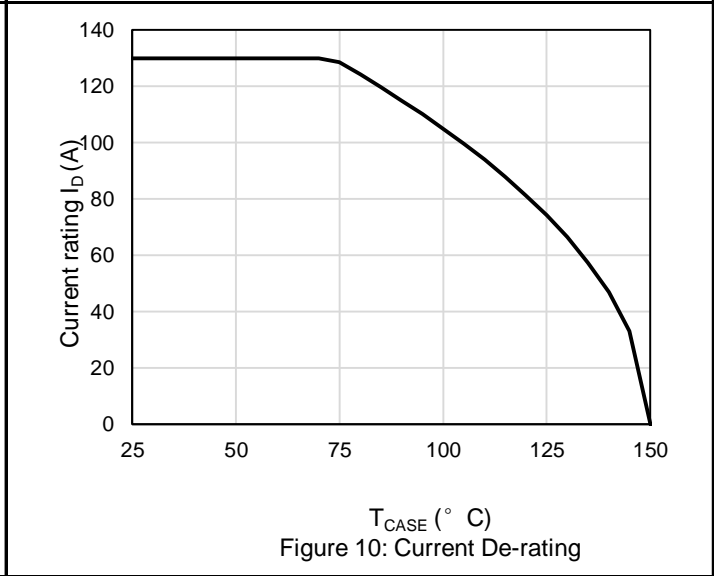
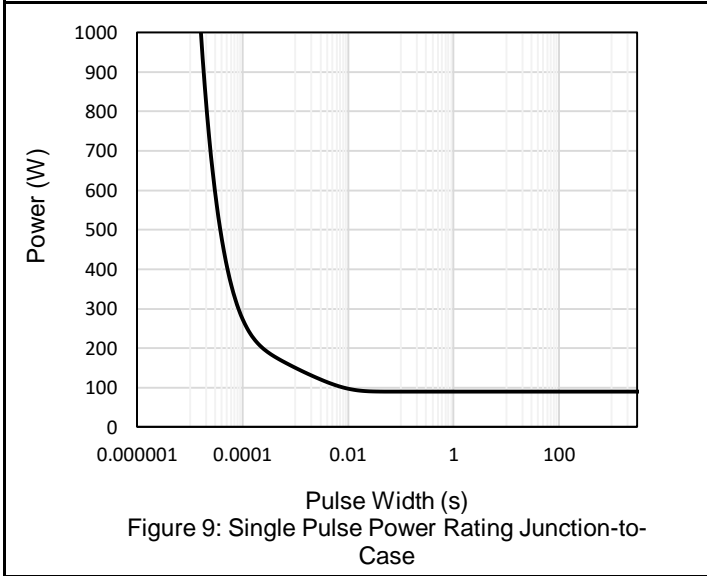
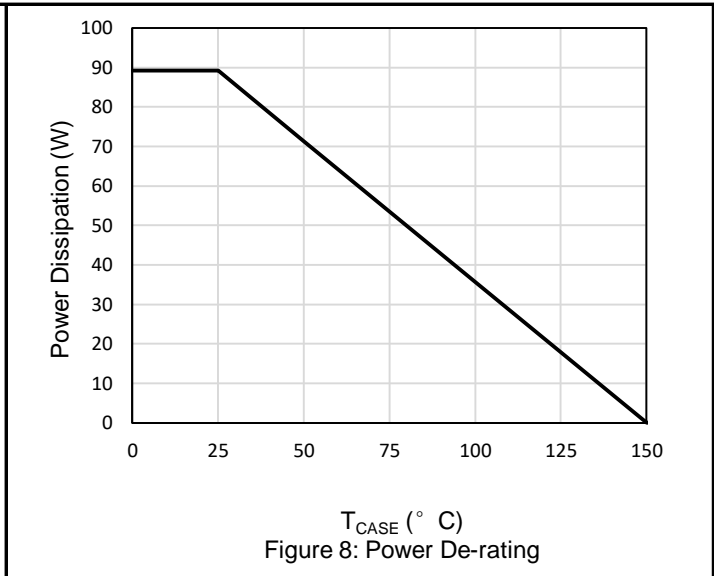
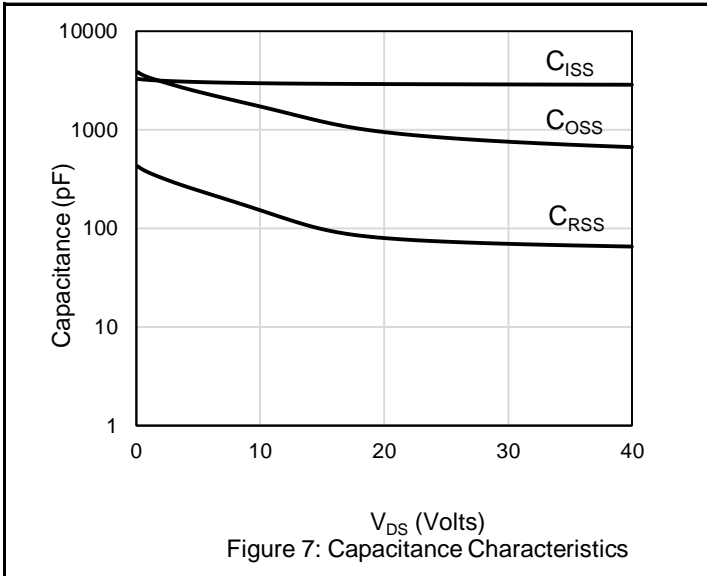

Test Circuit and Waveform

Gate Charge Test Circuit & Waveform

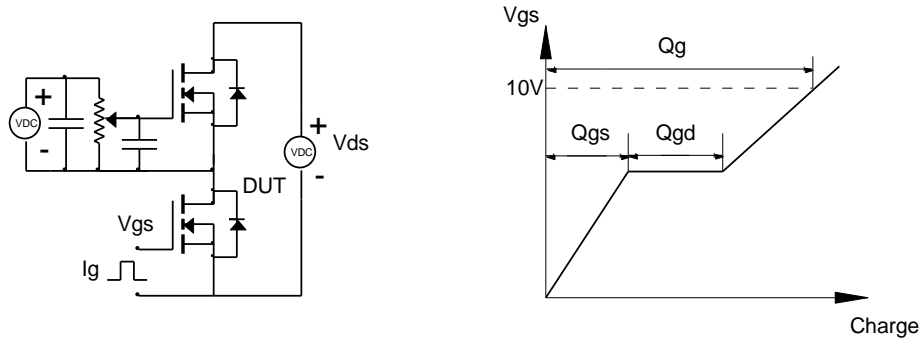

Resistive Switching Test Circuit & Waveforms

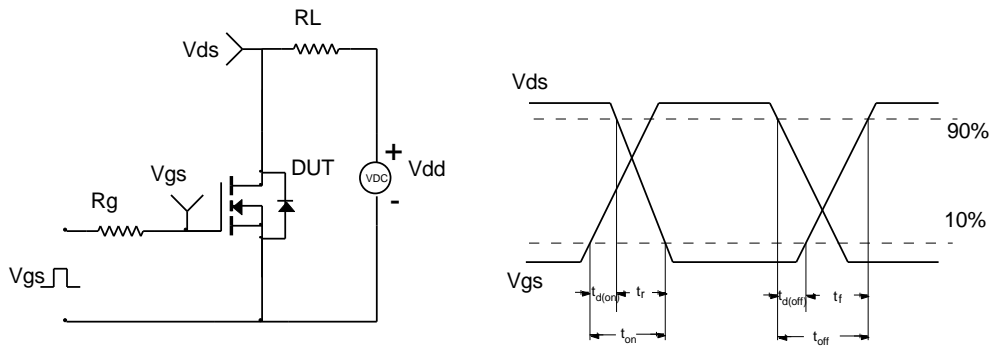

Unclamped Inductive Switching (UIS) Test Circuit & Waveforms

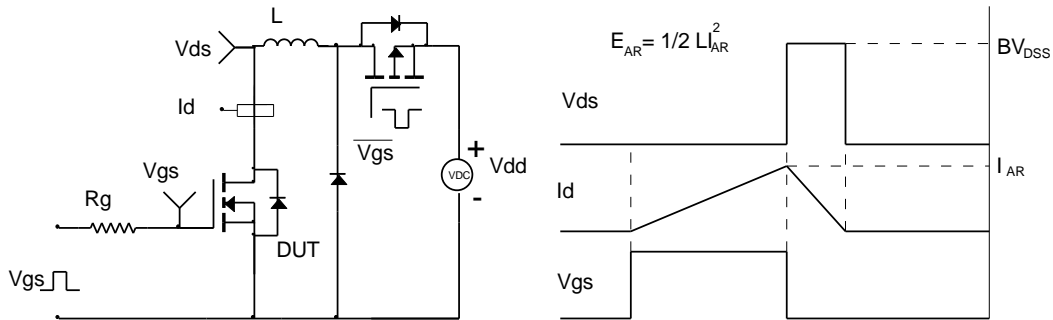

Diode Recovery Test Circuit & Waveforms

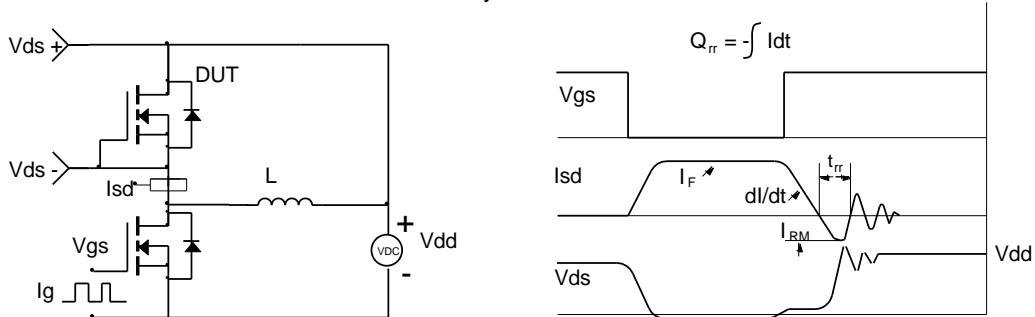

Package Outlines

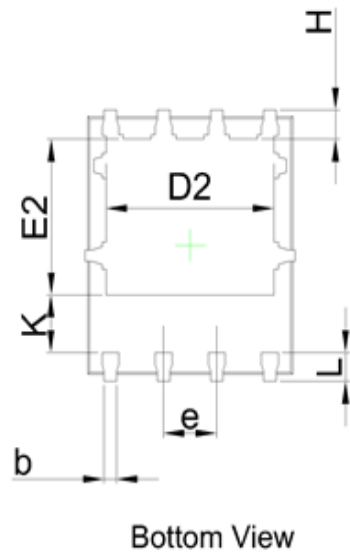
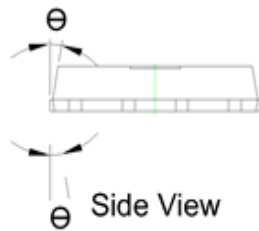
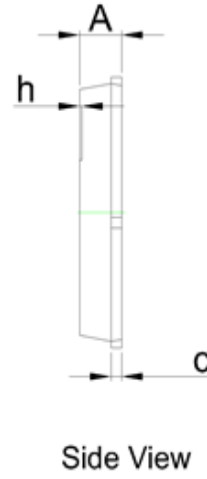
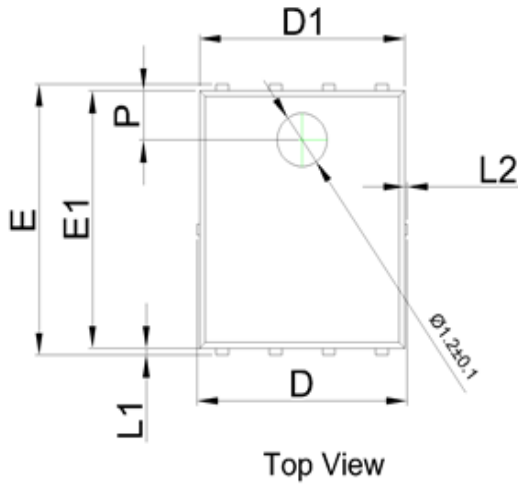

	MIN	NOM	MAX
A	0.90	1.00	1.10
b	0.20	0.30	0.40
c	0.21	0.25	0.34
D	-	-	5.10
D1	4.80	4.90	5.00
D2	3.91	4.01	4.11
e	1.27 BSC		
E	5.90	6.00	6.10
E1	5.65	5.75	5.85
E2	3.375	3.475	3.575
H	0.55	0.65	0.75
h	-	-	0.10
K	1.20	-	-
L	0.55	0.65	0.75
L1	0.05	0.15	0.25
L2	-	-	0.12
Θ	8°	10°	12°
P	1.00	1.10	1.20

Unit in mm

Marking Information

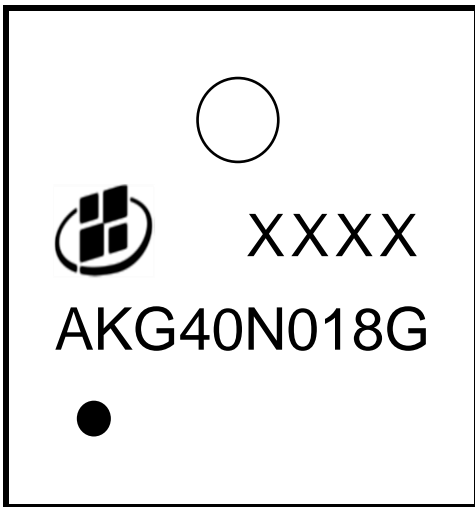

Note:

AKG40N018G = Product Name Code

XXXX = Date code

Contact ALKAIDSEMI sales for detail information

Tape & Reel Information

REEL DIMENSIONS

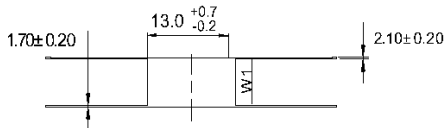
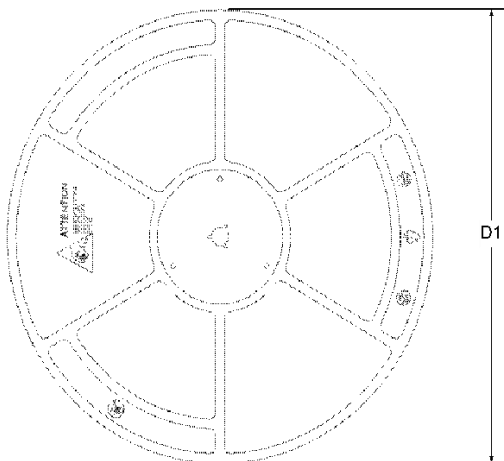

TAPE DIMENSIONS

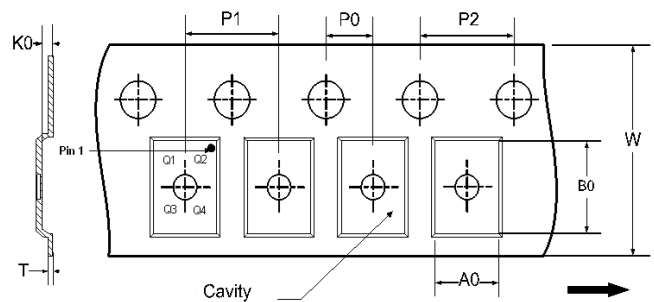

A0: Dimension designed to accommodate the component width

B0: Dimension designed to accommodate the component length

K0: Dimension designed to accommodate the component thickness

W: Overall width of the carrier tape

P0: Pitch between successive cavity centers and sprocket hole

P1: Pitch between successive cavity centers

P2: Pitch between sprocket hole

T: Tape material thickness

D1: Reel Diameter

W1: Reel Width

DIMENSIONS										(Unit: mm)
Reel	D1	W1								Material
	330	12.4								Hips
Tape	P0	P1	P2	W	A0	B0	K0	T	Pin 1 Quadrant	Material
	2	8	4	12	6.3	5.3	1.2	0.25	Q2	PC

All dimensions are nominal

Revision History

Revision	Release Date	Remark
Rev.1.3	2023/7/20	

Disclaimer

The information given in this document describes the independent performance of the product, but similar performance is not guaranteed under other working conditions, and cannot be guaranteed when installed with other products or equipment. To achieve the required performance of the product in actual scenarios, the customer should conduct a complete application test to assess the functionality of the product.

Alkaidsemi assumes no responsibility for equipment failures result from using products at values that exceed the ratings, operating conditions, or other parameters listed in the product specifications.

The product described in this specification is not applicable for aerospace or other applications which requires high reliability. Customers using or selling these products for use in medical, life-saving, or life-sustaining applications do so at their own risk and agree to fully indemnify.

Due to product or technical improvements, the information described or contained herein may be changed without prior notice.