

650V 2.2ohm N-channel SGT MOSFET AKS65N2M2KMF

Description:

This SJ device provides good FOM performance, better EMI for customer application.

Features:

- Low $R_{DS(ON)}$
- RoHS compliant ^(Note 1)
- Halogen-free ^(Note 1)
- 100% UIS tested

Applications:

- High Frequency Switching
- Quick Charging and Adapter

Key Performance Parameters:

Parameter	Value	Unit
V_{DS}	650	V
$R_{DS(ON), max}$ @ $V_{GS} = 10$ V	2.2	Ω
I_D	2	A

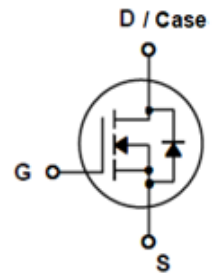
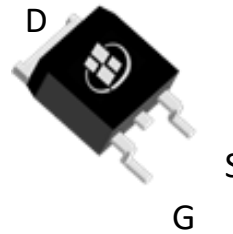

Ordering Information:

Ordering Code	Package Type	Marking Code	Form	Packing
AKS65N2M2KMF	TO-252	S65N2M2KMF	Tape Reel	2500PCS

Notes:

1. Contact ALKAIDSEMI sales for detail information

Maximum Ratings ($T_A = 25^\circ\text{C}$ unless otherwise noted)

Symbol	Parameter	Value	Units
V_{DS}	Drain-Source Voltage	650	V
I_D	Drain Current - Continuous ($T_C = 25^\circ\text{C}$) ^(Note 1)	2	A
	Drain Current - Continuous ($T_C = 100^\circ\text{C}$)	1.8	A
I_{DM}	Drain Current - Pulsed ^(Note 2)	6	A
V_{GS}	Gate-Source Voltage	± 30	V
E_{AS}	Single Pulsed Avalanche Energy ^(Note 3)	6	mJ
P_D	Power Dissipation ($T_C = 25^\circ\text{C}$)	36	W
dV/dT	MOSFET dv/dt ruggedness	50	V/ns
	Reverse diode dv/dt	15	
T_J, T_{STG}	Operating and Storage Temperature Range	-55 to +150	$^\circ\text{C}$

Thermal Characteristics

Symbol	Parameter	Value	Units
$R_{\theta JC}$	Thermal Resistance, Junction-to-Case, Steady-State	3.5	$^\circ\text{C}/\text{W}$
$R_{\theta JA}$	Thermal Resistance, Junction-to-Ambient, Steady State ^(Note 4)	55	$^\circ\text{C}/\text{W}$

Notes:

1. The max drain current rating is silicon limited
2. Repetitive Rating: Pulse width limited by maximum junction temperature
3. $L = 22.5 \text{ mH}$, $V_{DD} = 50 \text{ V}$, $I_{AS} = 1 \text{ A}$, $R_g = 50 \text{ } \Omega$, Starting $T_J = 25 \text{ } ^\circ\text{C}$
4. Mount on minimum PCB layout

Electrical Characteristics (T _J = 25°C unless otherwise noted)						
Symbol	Parameter	Test Conditions	Min	Typ	Max	Units
Static Characteristics						
V _{(BR)DSS}	Drain-Source Breakdown Voltage	V _{GS} = 0 V, I _D = 250 μA	650			V
I _{DSS}	Zero Gate Voltage Drain Current	V _{DS} = 650 V, V _{GS} = 0 V			1	μA
I _{GSS}	Gate Leakage Current	V _{GS} = ± 30 V, V _{DS} = 0 V			±100	nA
V _{GS(th)}	Gate Threshold voltage	V _{DS} = V _{GS} , I _D = 250 μA	2.5	3.7	4.5	V
R _{DS(ON)}	Drain-Source on-state resistance	V _{GS} = 10 V, I _D = 1 A		1.8	2.2	Ω
Dynamic Characteristics						
C _{iss}	Input Capacitance	V _{DS} = 50 V, V _{GS} = 0 V, f = 1 MHz		159		pF
C _{oss}	Output Capacitance			22		pF
C _{rss}	Reverse Transfer Capacitance			2.5		pF
R _g	Gate Resistance	f = 1 MHz		9.2		Ω
Switching Characteristics						
t _{d(on)}	Turn On Delay Time	V _{DD} = 400 V, R _L = 400 Ω, V _{GS} = 10 V, R _G = 50 Ω		28		ns
t _r	Rise Time			13		ns
t _{d(off)}	Turn Off Delay Time			63		ns
t _f	Fall Time			58		ns
Q _g	Total Gate Charge	V _{DD} = 400 V, I _D = 1 A, V _{GS} = 10 V		8.1		nC
Q _{gs}	Gate-Source Charge			6.9		nC
Q _{gd}	Gate-Drain Charge			0.7		nC
Drain-Source Diode Characteristics and Maximum Ratings						
I _S	Maximum Continuous Body-Diode Forward Current				2	A
I _{SM}	Maximum Pulsed Body-Diode Forward Current ^(NOTE 1)				6	A
V _{SD}	Diode Forward Voltage	V _{GS} = 0 V, I _S = 1 A		0.87	1.4	V
t _{rr}	Reverse recovery time	V _{DD} = 400 V, I _D = 1 A, di/dt = 100 A/μS		51		ns
Q _{rr}	Reverse recovery charge			114		nC
I _{rrm}	Peak Reverse Recovery Current			4.2		A

Electrical Characteristics Diagrams

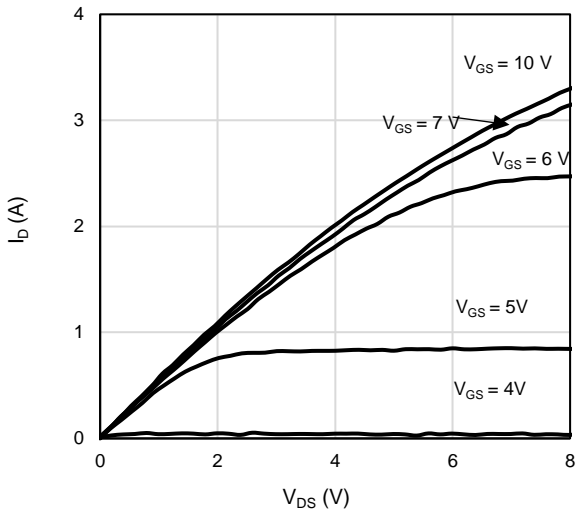

Figure 1: On-Region Characteristics

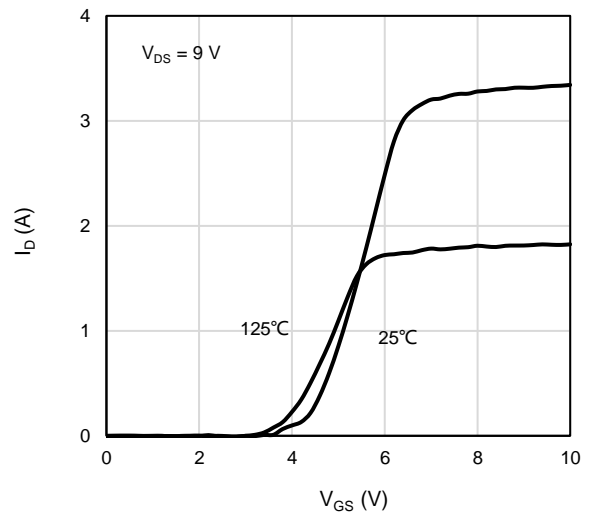

Figure 2: Transfer Characteristics

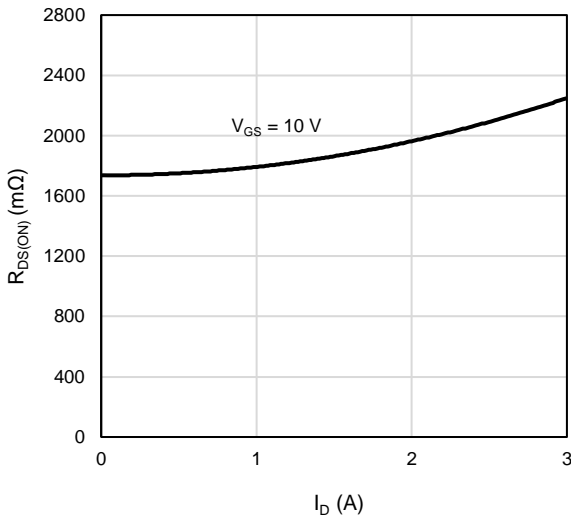

Figure 3: On-Resistance vs. Drain Current and Gate Voltage

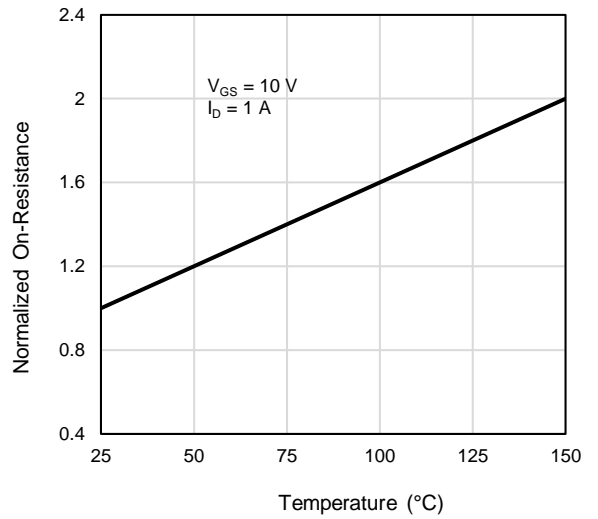

Figure 4: On-Resistance vs. Junction Temperature

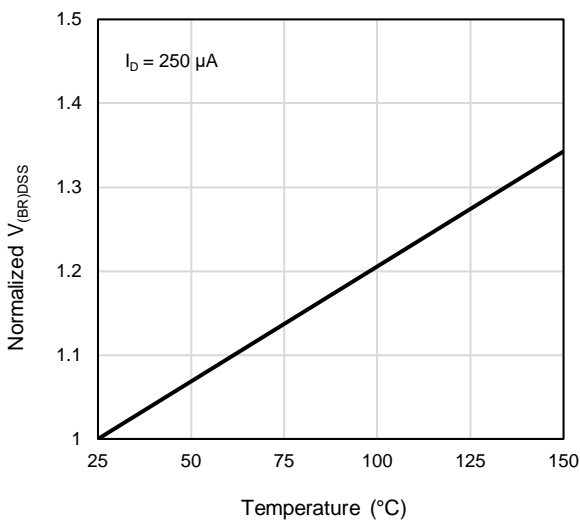

Figure 5: Breakdown Voltage vs. Junction Temperature

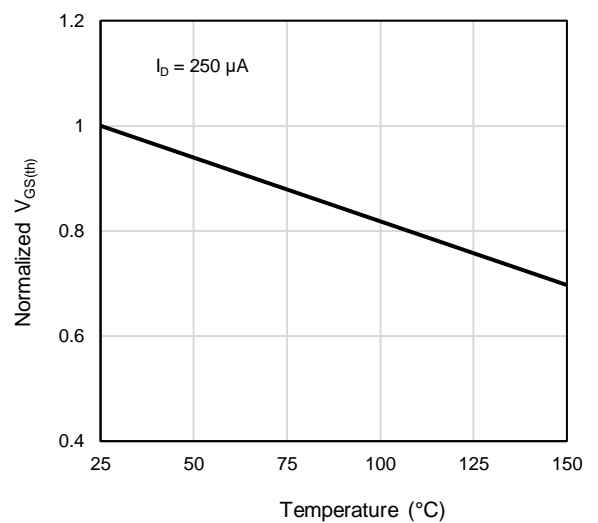

Figure 6: Threshold Voltage vs. Junction Temperature

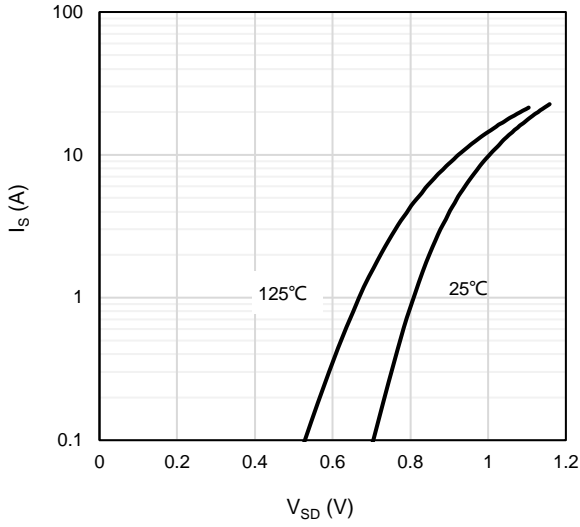

Figure 7: Body-Diode Characteristics

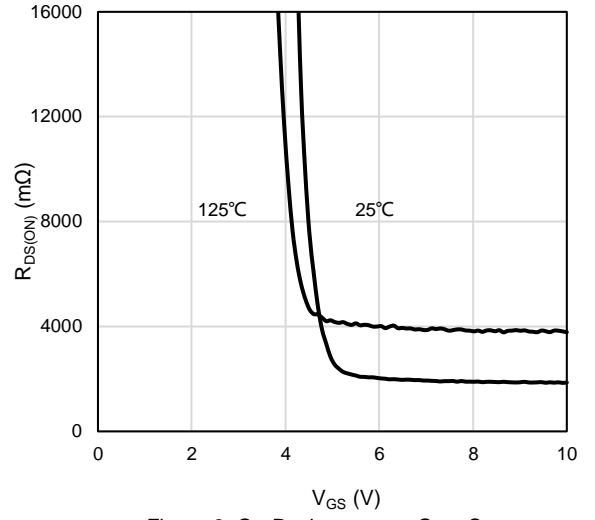

Figure 8: On-Resistance vs. Gate-Source Voltage

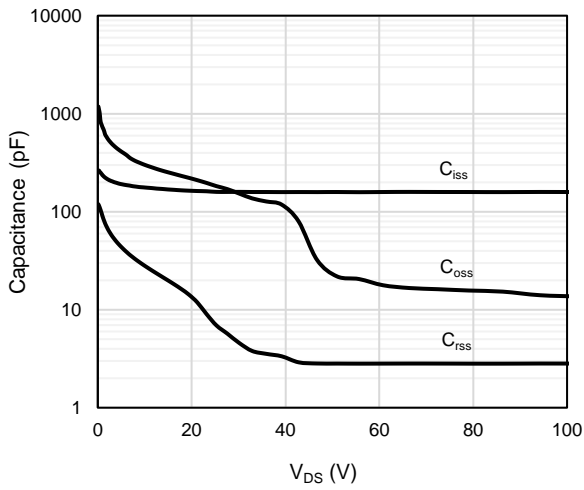

Figure 9: Capacitance Characteristics

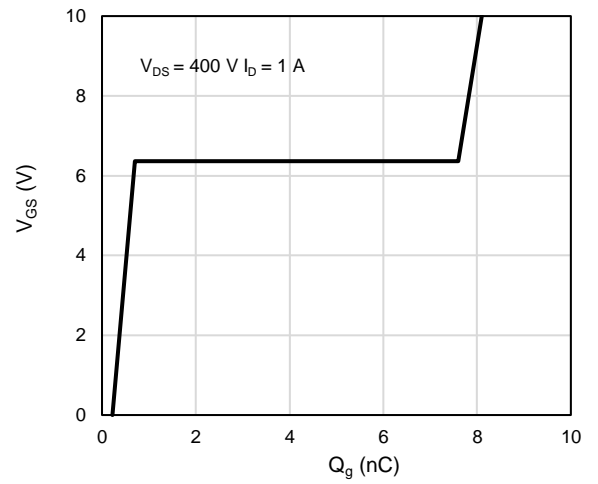

Figure 10: Gate-Charge Characteristics

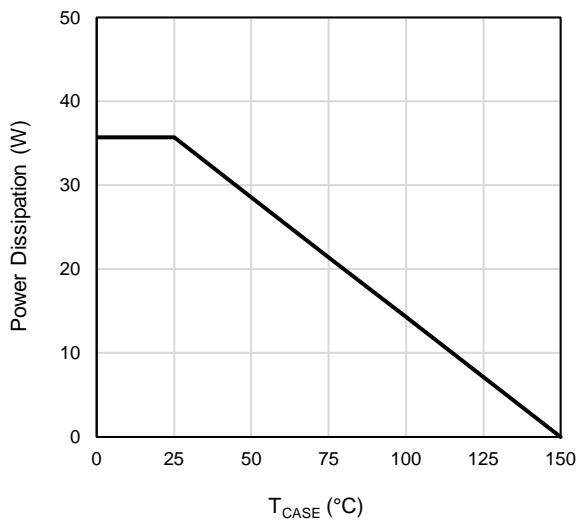

Figure 11: Power De-rating

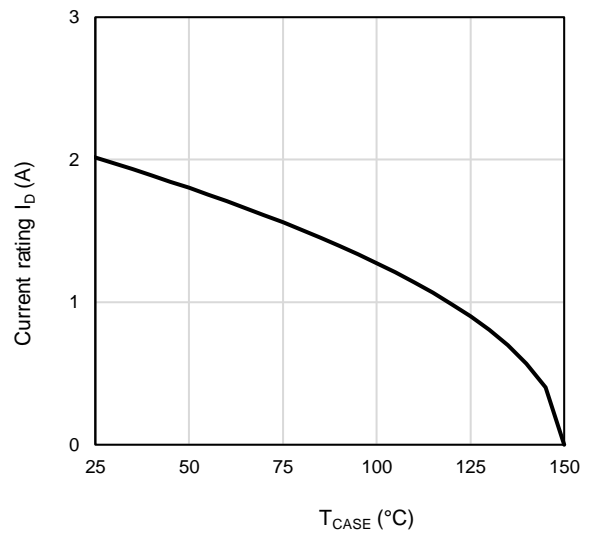

Figure 12: Current De-rating

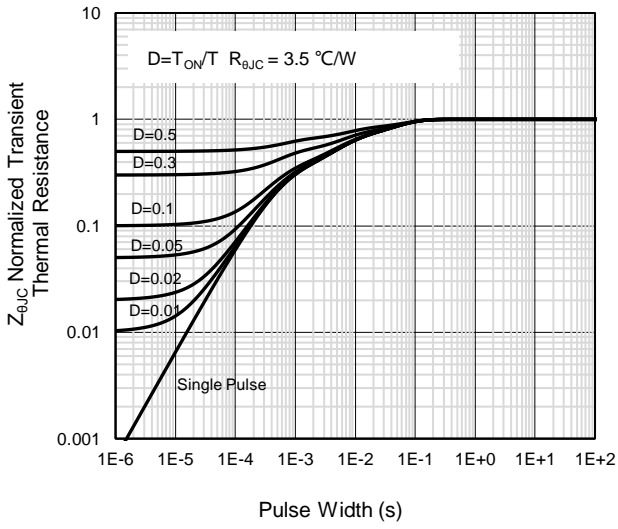

Figure 13: Normalized Maximum Transient Thermal Impedance

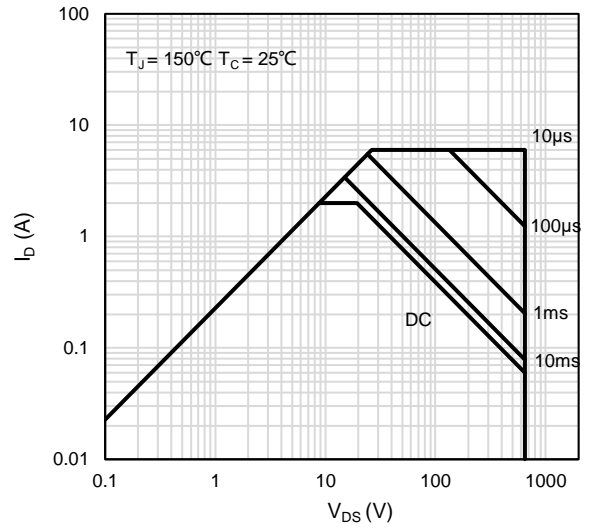
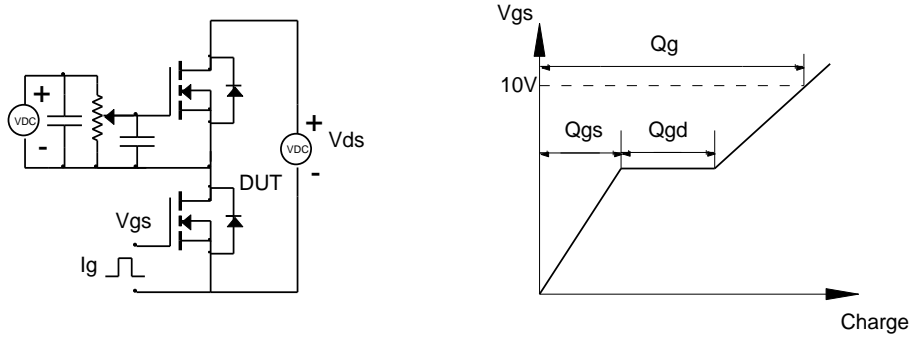

Figure 14: Maximum Forward Biased Safe Operating Area

Test Circuit and Waveform

Gate Charge Test Circuit & Waveform



Resistive Switching Test Circuit & Waveforms

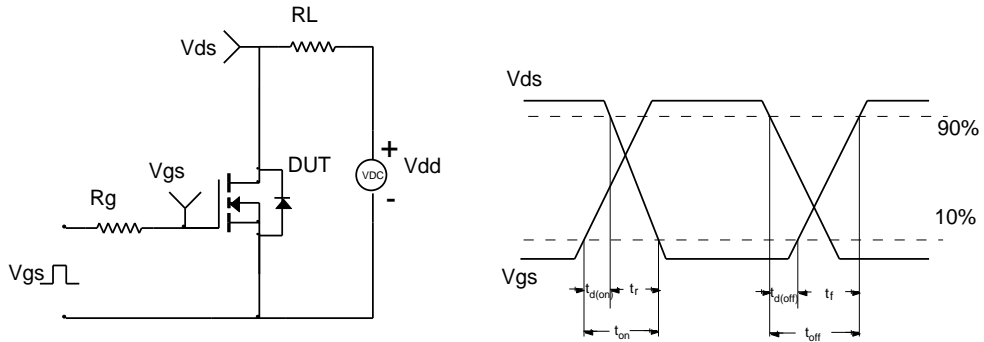

Unclamped Inductive Switching (UIS) Test Circuit & Waveforms

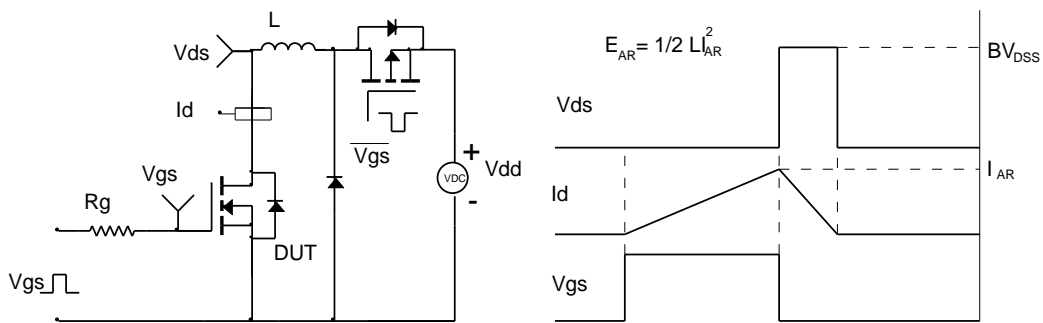

Diode Recovery Test Circuit & Waveforms

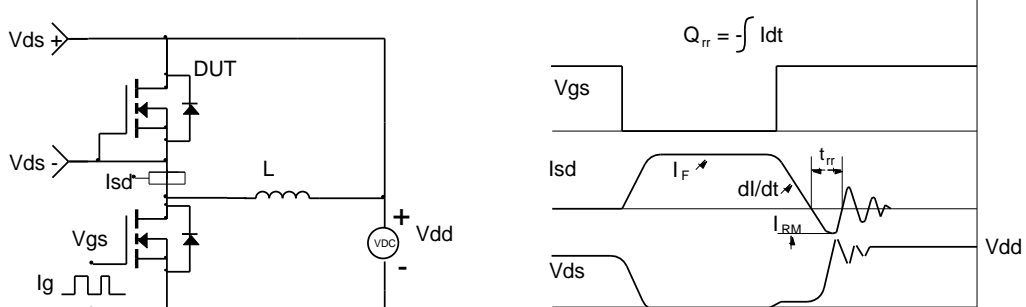

Package Outlines

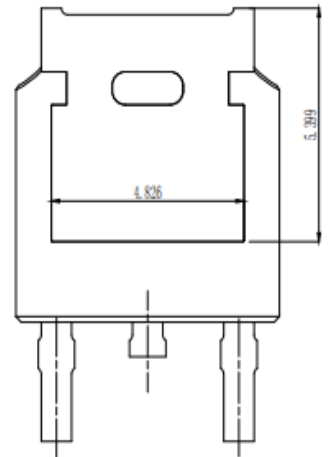
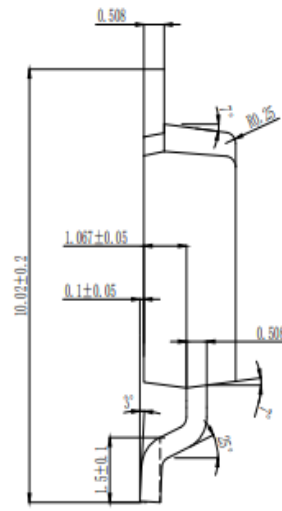
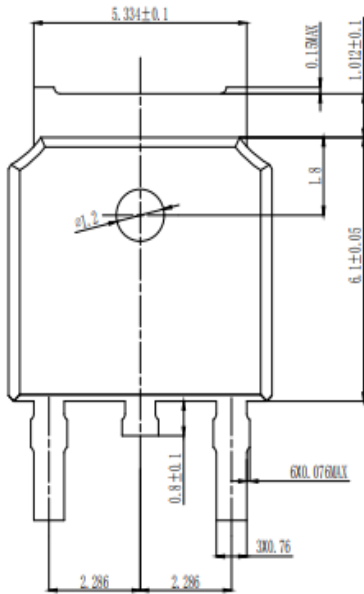
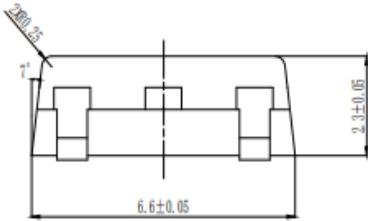

Marking Information



Note:

S65N2M2KMF = Product Name Code

XXXXXXX = Date code

Contact ALKAIDSEMI sales for detail information

Tape & Reel Information

REEL DIMENSIONS

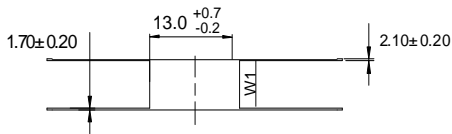
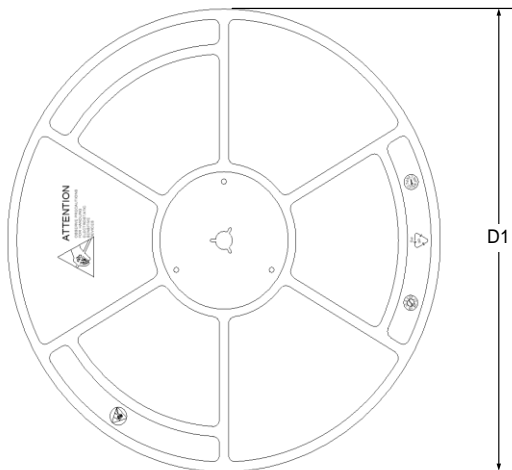

TAPE DIMENSIONS

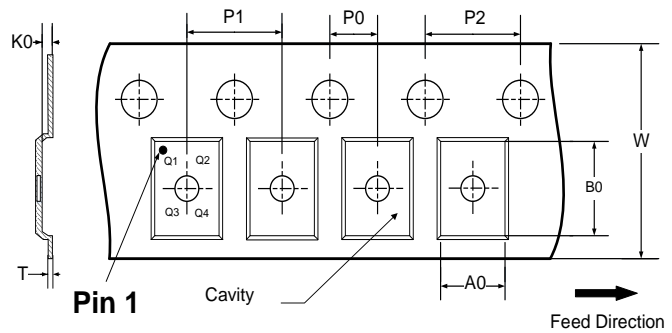

- A0: Dimension designed to accommodate the component width
- B0: Dimension designed to accommodate the component length
- K0: Dimension designed to accommodate the component thickness
- W: Overall width of the carrier tape
- P0: Pitch between successive cavity centers and sprocket hole
- P1: Pitch between successive cavity centers
- P2: Pitch between sprocket hole
- T: Tape material thickness
- D1: Reel Diameter
- W1: Reel Width

DIMENSIONS										(Unit: mm)
Reel	D1	W1								Material
	330	20.5								Hips
Tape	P0	P1	P2	W	A0	B0	K0	T	Pin 1 Quadrant	Material
	4	8	2	16	6.9	10.5	2.9	0.27	Q1	PC
All dimensions are nominal										

Revision History

Revision	Released	Remark
Rev.1.0	2023	Initial Release

Disclaimer

The information given in this document describes the independent performance of the product, but similar performance is not guaranteed under other working conditions, and cannot be guaranteed when installed with other products or equipment. To achieve the required performance of the product in actual scenarios, the customer should conduct a complete application test to assess the functionality of the product.

Alkaidsemi assumes no responsibility for equipment failures result from using products at values that exceed the ratings, operating conditions, or other parameters listed in the product specifications.

The product described in this specification is not applicable for aerospace or other applications which requires high reliability. Customers using or selling these products for use in medical, life-saving, or life-sustaining applications do so at their own risk and agree to fully indemnify.

Due to product or technical improvements, the information described or contained herein may be changed without prior notice.