

650V 50A Insulated Gate Bipolar Transistor AKB65A050WHS

Description:

Gen 3 IGBT with soft, fast recovery full current rated anti-parallel Emitter Controlled diode, providing ultra-low conduction loss. They are designed for applications such as UPS, inverters, etc.

Features:

- Easy paralleling capability due to positive temperature coefficient in V_{CESAT}
- Low EMI
- Low Gate Charge
- Very soft, fast recovery full current anti-parallel diode
- Maximum junction temperature $T_{VJmax}=175^{\circ}C$
- RoHS compliant ^(Note 1)
- Halogen-free ^(Note 1)

Applications:

- Industrial UPS
- Charger
- Energy Storage
- Three-Phase Solar String Inverter

Key Performance Parameters:

Parameter	Value	Unit
V_{CE}	650	V
$V_{CESAT}, T_{VJ} = 25^{\circ}C$	1.35	V
I_C	50	A

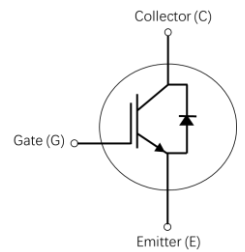
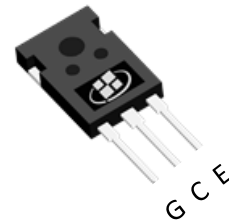

Ordering Information:

Ordering Code	Package Type	Marking Code	Form	Packing
AKB65A050WHS	TO247-3L	B65A050WHS	Tube	300PCS

Notes:

1. Contact ALKAIDSEMI sales for detail information

Maximum Ratings ($T_{VJ} = 25^{\circ}\text{C}$ unless otherwise noted)

Symbol	Parameter	Value	Units
V_{CE}	Collector-Emitter Voltage	650	V
I_C	Collector Current - Continuous ($T_{VJ} = 25^{\circ}\text{C}$) ^(Note 1)	80	A
	Collector Current - Continuous ($T_{VJ} = 100^{\circ}\text{C}$)	50	A
I_{CM}	Collector Current - Pulsed ^(Note 2)	200	A
I_F	Diode Forward Current, Limited by T_{VJmax} ($T_{VJ} = 25^{\circ}\text{C}$)	80	A
	Diode Forward Current, Limited by T_{VJmax} ($T_{VJ} = 100^{\circ}\text{C}$)	50	A
I_{FM}	Diode Pulsed Current, - Pulsed ^(Note 2)	200	A
V_{GE}	Gate-Emitter Voltage	± 20	V
	Transient Gate-Emitter Voltage ($t_p \leq 10\mu\text{s}$, $D < 0.010$)	± 30	
P_D	Power Dissipation ($T_{VJ} = 25^{\circ}\text{C}$)	258	W
	Power Dissipation ($T_{VJ} = 100^{\circ}\text{C}$)	129	W
T_J	Operating Junction Temperature Range	-40 to +175	$^{\circ}\text{C}$
T_{STG}	Storage Temperature Range	-55 to +150	$^{\circ}\text{C}$

Thermal Characteristics

Symbol	Parameter	Value	Units
$R_{\theta JC}$	IGBT Thermal Resistance, Junction-to-Case, Steady-State	0.58	$^{\circ}\text{C}/\text{W}$
$R_{\theta JC}$	Diode Thermal Resistance, Junction-to-Case, Steady-State	0.65	$^{\circ}\text{C}/\text{W}$
$R_{\theta JA}$	Thermal Resistance, Junction-to-Ambient Steady State	40	$^{\circ}\text{C}/\text{W}$

Notes:

1. The max collector current rating is package limited
2. Repetitive rating: pulse width limited by maximum junction temperature

Electrical Characteristics ($T_{VJ} = 25^{\circ}\text{C}$ unless otherwise noted)

Symbol	Parameter	Test Conditions	Min	Typ	Max	Units
Static Characteristics						
$V_{(BR)CES}$	Collector-Emitter Breakdown Voltage	$V_{GE} = 0\text{ V}, I_C = 0.2\text{ mA}$	650			V
V_{CESAT}	Collector-Emitter Saturation Voltage	$V_{GE} = 15\text{ V}, I_C = 50\text{ A}$		1.35	1.70	V
		$V_{GE} = 15\text{ V}, I_C = 50\text{ A}, T_{VJ} = 125^{\circ}\text{C}$		1.53		
		$V_{GE} = 15\text{ V}, I_C = 50\text{ A}, T_{VJ} = 175^{\circ}\text{C}$		1.65		
V_F	Diode Forward Voltage	$V_{GE} = 0\text{ V}, I_F = 50\text{ A}$		1.45	1.85	V
		$V_{GE} = 0\text{ V}, I_F = 50\text{ A}, T_{VJ} = 125^{\circ}\text{C}$		1.50		
		$V_{GE} = 0\text{ V}, I_F = 50\text{ A}, T_{VJ} = 175^{\circ}\text{C}$		1.53		
$V_{GE(TH)}$	Gate-Emitter Threshold Voltage	$V_{CE} = V_{GE}, I_C = 0.5\text{ mA}$	3.2	4.0	4.8	V
I_{CES}	Zero Gate Voltage Collector Current	$V_{CE} = 650\text{ V}, V_{GE} = 0\text{ V}$			50	μA
		$V_{CE} = 650\text{ V}, V_{GE} = 0\text{ V}, T_{VJ} = 175^{\circ}\text{C}$		2000		
I_{GES}	Gate-Emitter Leakage Current	$V_{GE} = \pm 20\text{ V}, V_{CE} = 0\text{ V}$			100	nA
G_{FS}	Transconductance	$V_{GE} = 20\text{ V}, I_C = 50\text{ A}$		52		S
Dynamic Characteristics						
C_{IES}	Input Capacitance	$V_{CE} = 25\text{ V}, V_{GE} = 0\text{ V},$ $F = 1\text{ MHz}$		2925		pF
C_{OES}	Output Capacitance			144		pF
C_{RES}	Reverse Transfer Capacitance			17		pF
Q_G	Total Gate Charge	$V_{CC} = 520\text{ V}, I_C = 50\text{ A},$ $V_{GE} = 15\text{ V}$		112		nC
Q_{GE}	Gate-Emitter Charge			16		nC
Q_{GC}	Gate-Collector Charge			40		nC
L_E	Internal Emitter Inductance			8		nH
Switching Characteristics, Inductive Load ($T_{VJ} = 25^{\circ}\text{C}$)						
$T_{D(ON)}$	Turn On Delay Time	$V_{CC} = 400\text{ V}$ $I_C = 50\text{ A}$ $V_{GE} = 15\text{ V}$ $R_{Gon} = 8\ \Omega$ $R_{Goff} = 8\ \Omega$		25		ns
T_R	Rise Time			31		ns
$T_{D(OFF)}$	Turn Off Delay Time			151		ns
T_F	Fall Time			37		ns
E_{ON}	Turn On Energy			1.32		mJ
E_{OFF}	Turn Off Energy			0.67		mJ
E_{TOTAL}	Total Switching Energy			1.99		mJ

$T_{D(ON)}$	Turn On Delay Time	$V_{CC} = 400\text{ V}$ $I_C = 25\text{ A}$ $V_{GE} = 15\text{ V}$ $R_{Gon} = 8\ \Omega$ $R_{Goff} = 8\ \Omega$		21		ns
T_R	Rise Time			11		ns
$T_{D(OFF)}$	Turn Off Delay Time			174		ns
T_F	Fall Time			9		ns
E_{ON}	Turn On Energy			0.57		mJ
E_{OFF}	Turn Off Energy			0.32		mJ
E_{TOTAL}	Total Switching Energy			0.88		mJ

Diode Characteristics ($T_{VJ} = 25^\circ\text{C}$)

T_{RR}	Reverse Recovery Time	$V_R = 400\text{ V}, I_F = 50\text{ A},$ $di/dt = 1150\text{ A}/\mu\text{s}$		106		ns
Q_{RR}	Reverse Recovery Charge			1.7		μC
I_{RRM}	Peak Reverse Recovery Current			30		A
dI_{RR}/dt	Diode Peak Rate of Fall of Reverse Recovery Current			-184		$\text{A}/\mu\text{s}$

T_{RR}	Reverse Recovery Time	$V_R = 400\text{ V}, I_F = 25\text{ A},$ $di/dt = 1370\text{ A}/\mu\text{s}$		93		ns
Q_{RR}	Reverse Recovery Charge			1.2		μC
I_{RRM}	Peak Reverse Recovery Current			26		A
dI_{RR}/dt	Diode Peak Rate of Fall of Reverse Recovery Current			-314		$\text{A}/\mu\text{s}$

Switching Characteristics, Inductive Load ($T_{VJ} = 150^\circ\text{C}$)

$T_{D(ON)}$	Turn On Delay Time	$V_{CC} = 400\text{ V}$ $I_C = 50\text{ A}$ $V_{GE} = 15\text{ V}$ $R_{Gon} = 8\ \Omega$ $R_{Goff} = 8\ \Omega$		23		ns
T_R	Rise Time			29		ns
$T_{D(OFF)}$	Turn Off Delay Time			160		ns
T_F	Fall Time			46		ns
E_{ON}	Turn On Energy			1.56		mJ
E_{OFF}	Turn Off Energy			0.85		mJ
E_{TOTAL}	Total Switching Energy			2.41		mJ

$T_{D(ON)}$	Turn On Delay Time	$V_{CC} = 400\text{ V}$ $I_C = 25\text{ A}$ $V_{GE} = 15\text{ V}$ $R_{Gon} = 8\ \Omega$ $R_{Goff} = 8\ \Omega$		22		ns
T_R	Rise Time			13		ns
$T_{D(OFF)}$	Turn Off Delay Time			205		ns
T_F	Fall Time			32		ns
E_{ON}	Turn On Energy			0.75		mJ
E_{OFF}	Turn Off Energy			0.44		mJ
E_{TOTAL}	Total Switching Energy			1.19		mJ

Diode Characteristics ($T_{VJ} = 150^\circ\text{C}$)

T_{RR}	Reverse Recovery Time	$V_R = 400\text{ V}, I_F = 50\text{ A},$ $di/dt = 1150\text{ A}/\mu\text{s}$		154		ns
Q_{RR}	Reverse Recovery Charge			2.8		μC
I_{RRM}	Peak Reverse Recovery Current			36		A
$dirr/dt$	Diode Peak Rate of Fall of Reverse Recovery Current			-166		$\text{A}/\mu\text{s}$

T_{RR}	Reverse Recovery Time	$V_R = 400\text{ V}, I_F = 25\text{ A},$ $di/dt = 1370\text{ A}/\mu\text{s}$		131		ns
Q_{RR}	Reverse Recovery Charge			2.2		μC
I_{RRM}	Peak Reverse Recovery Current			33		A
$dirr/dt$	Diode Peak Rate of Fall of Reverse Recovery Current			-306		$\text{A}/\mu\text{s}$

Electrical Characteristics Diagrams

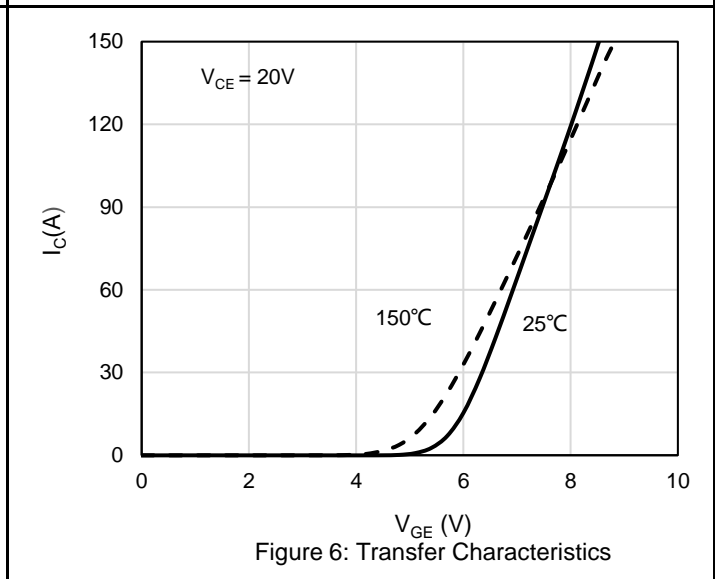
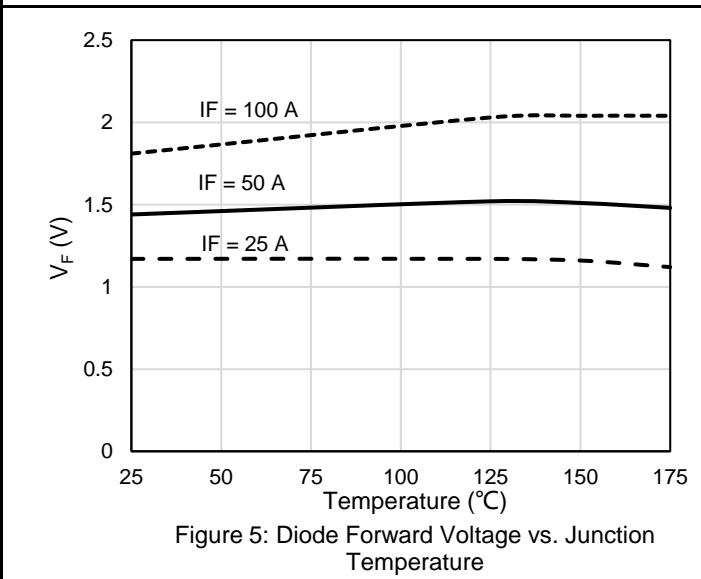
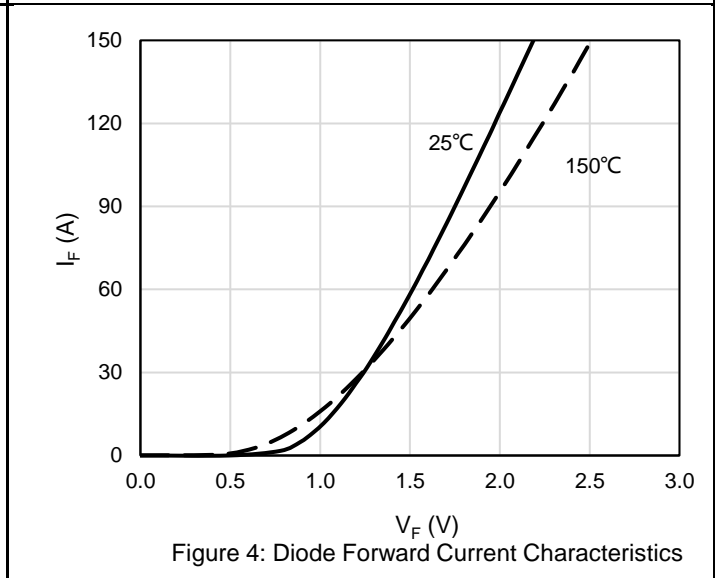
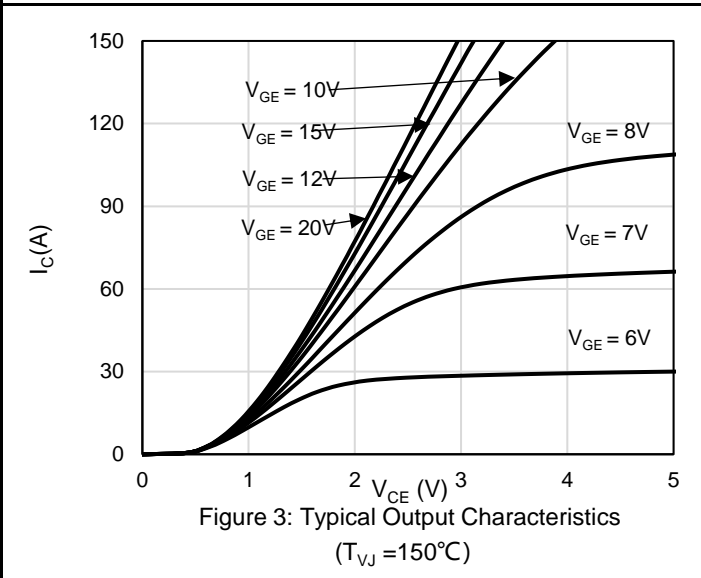
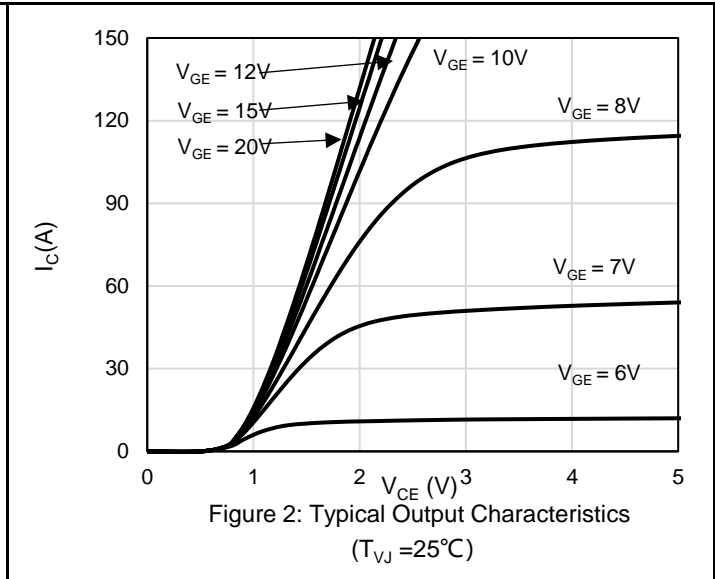
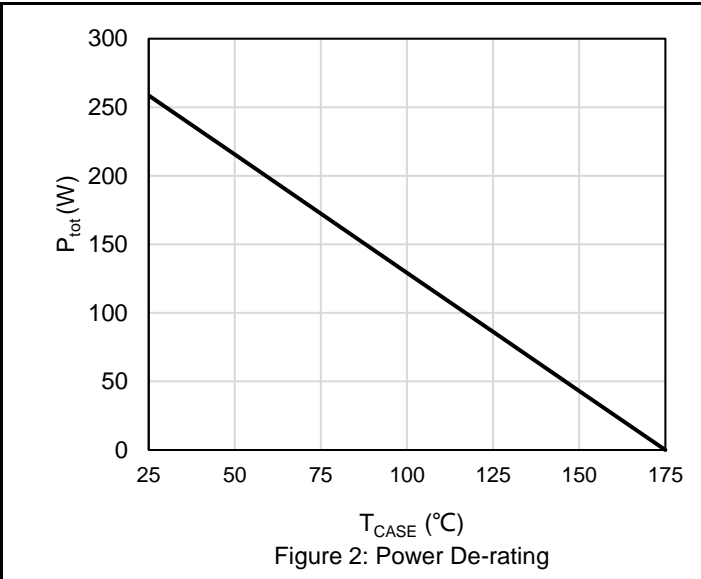

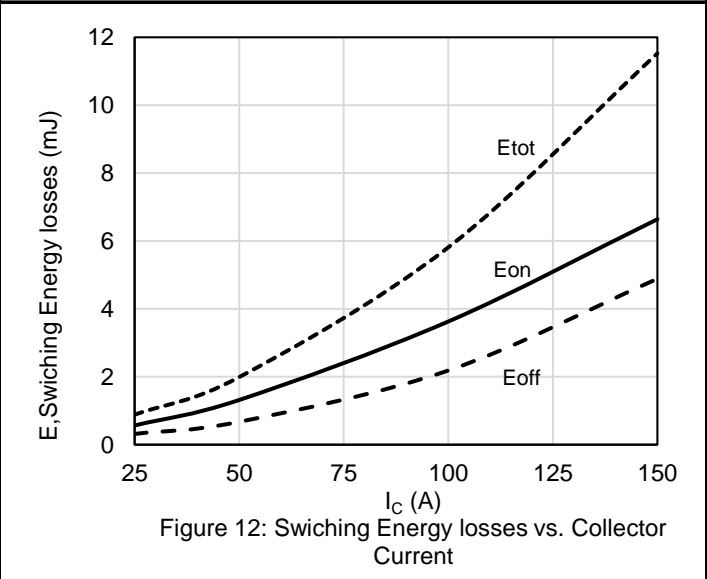
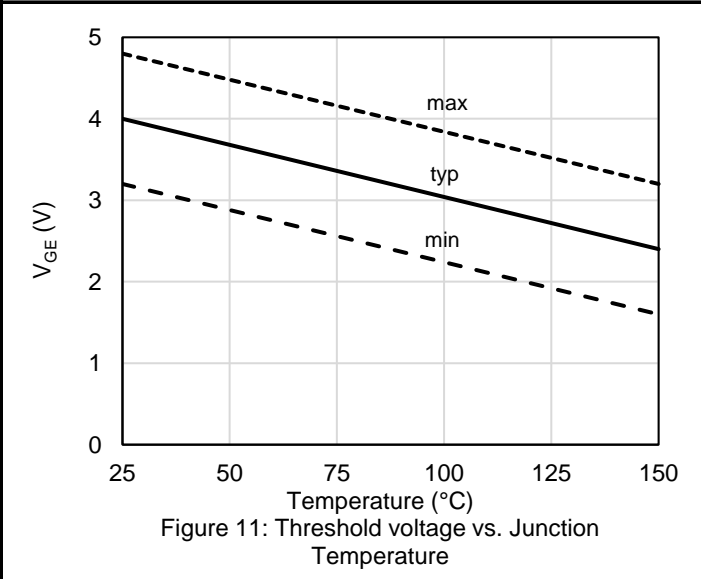
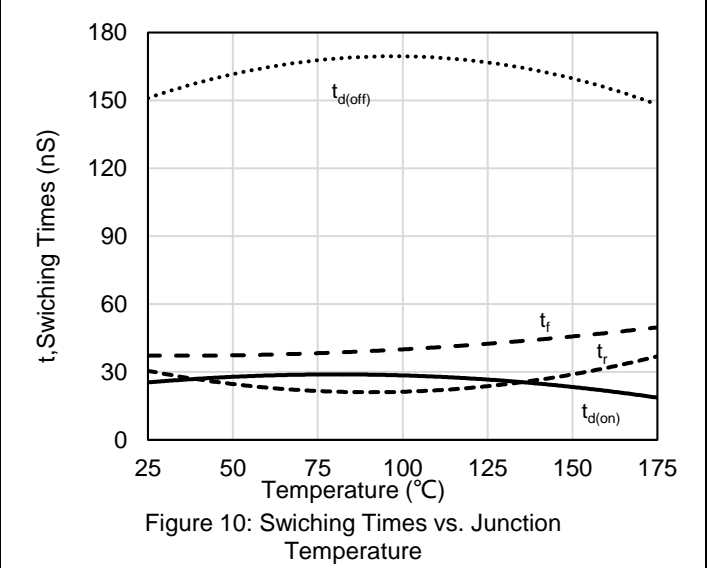
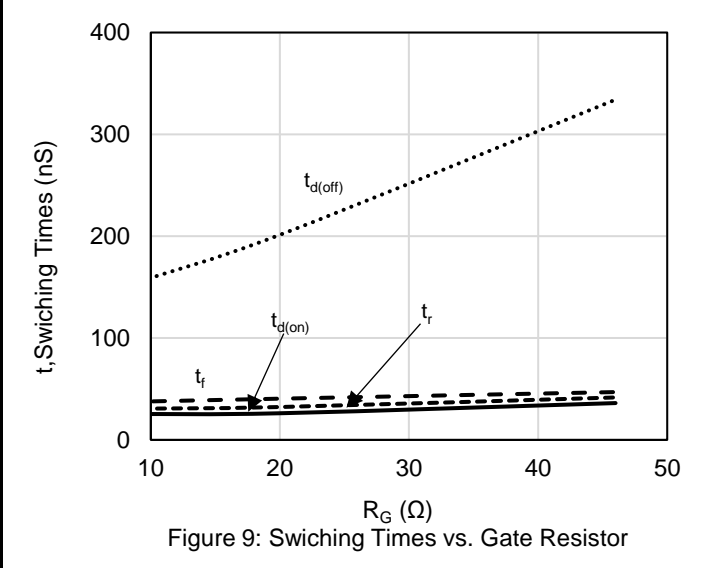
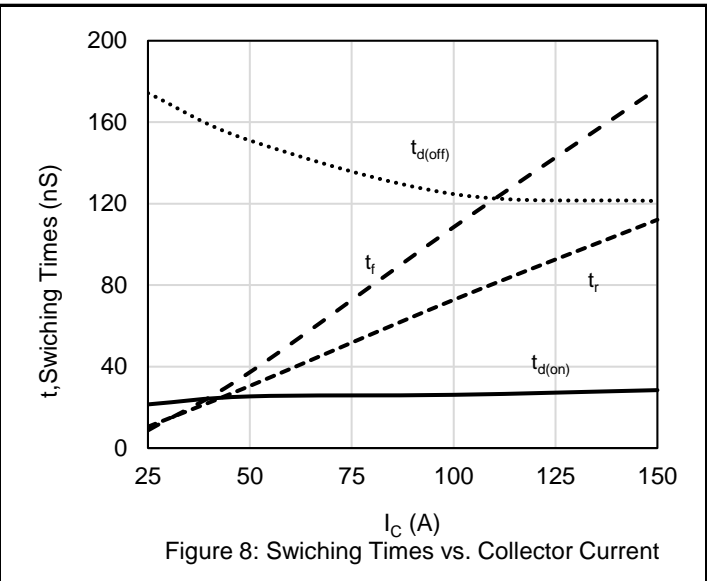
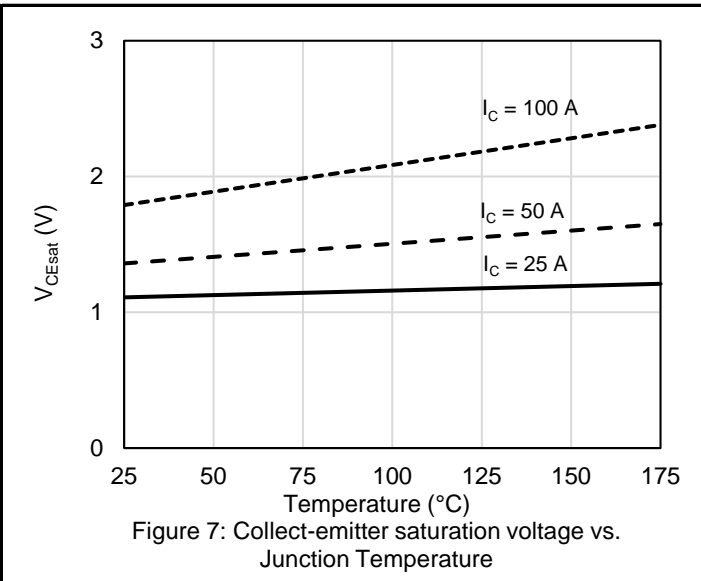

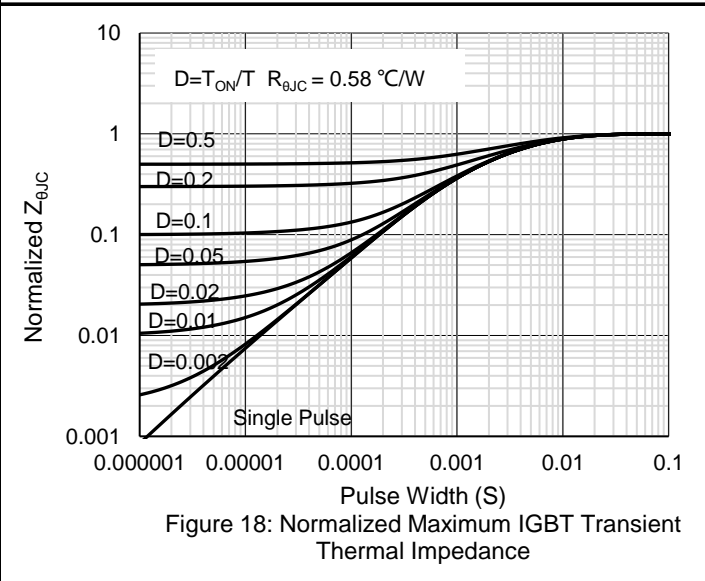
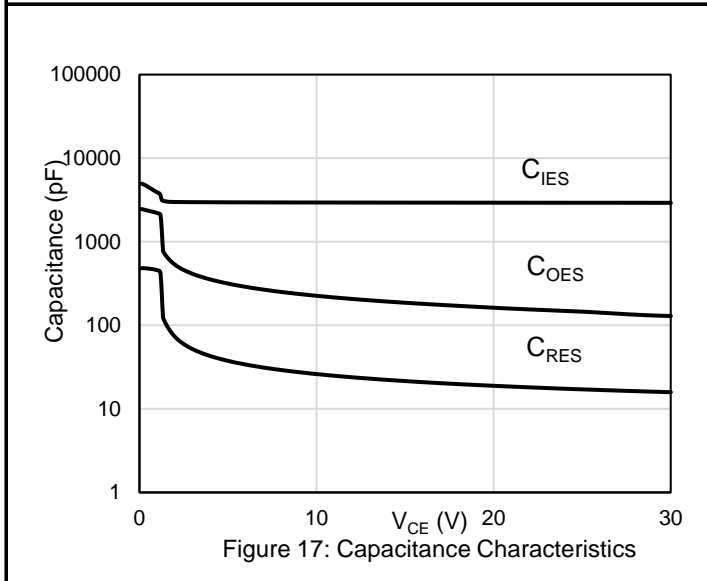
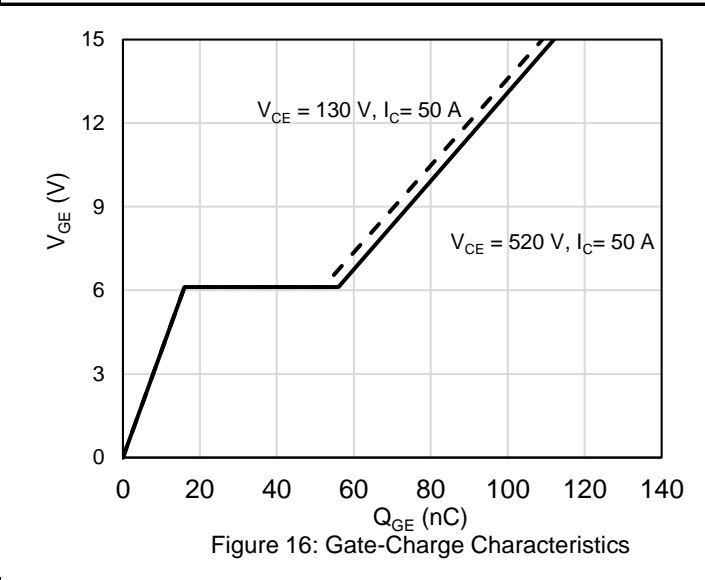
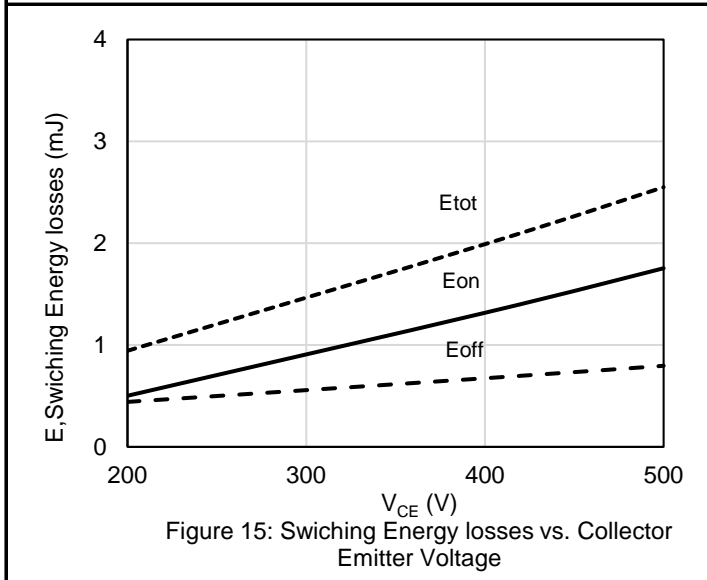
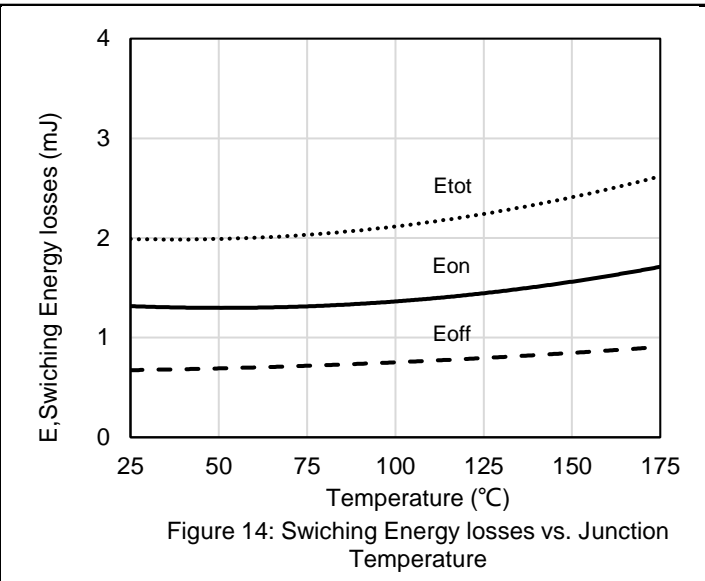
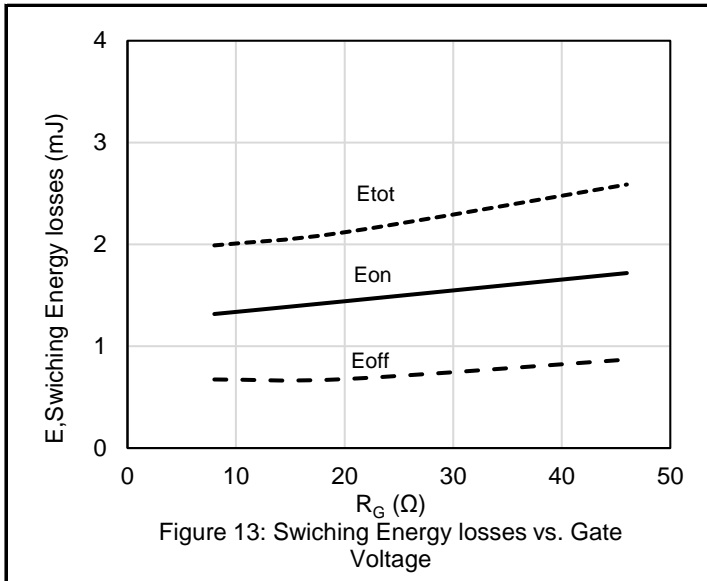

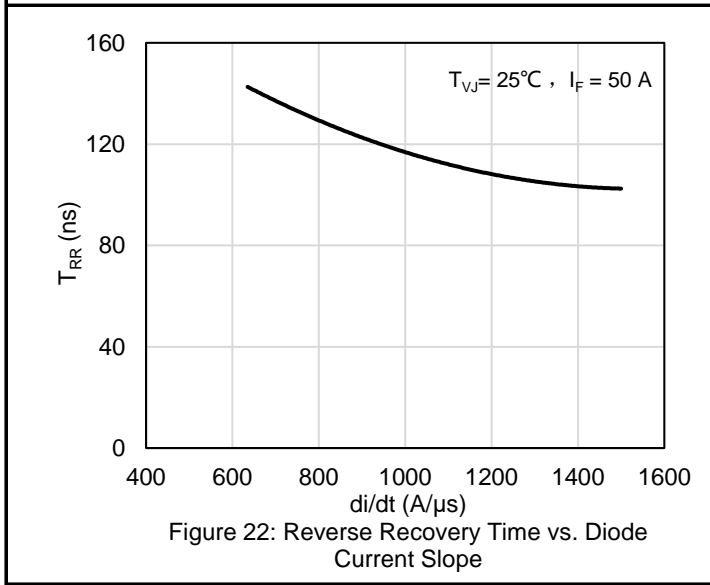
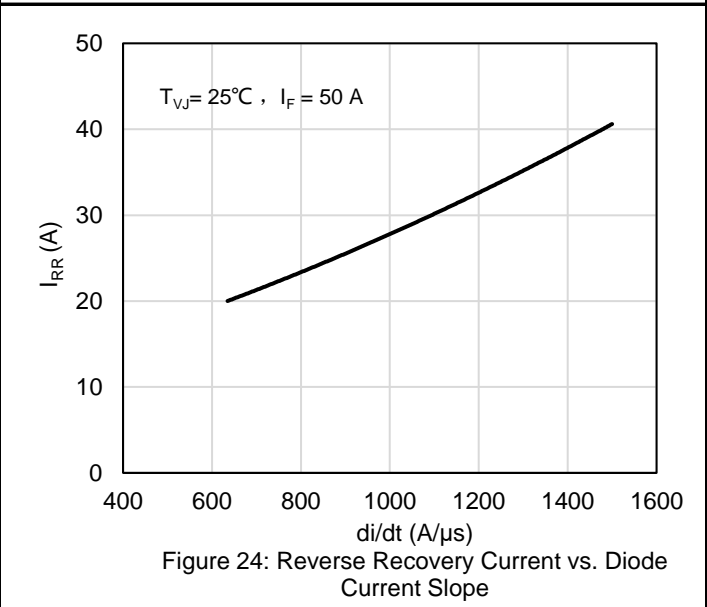
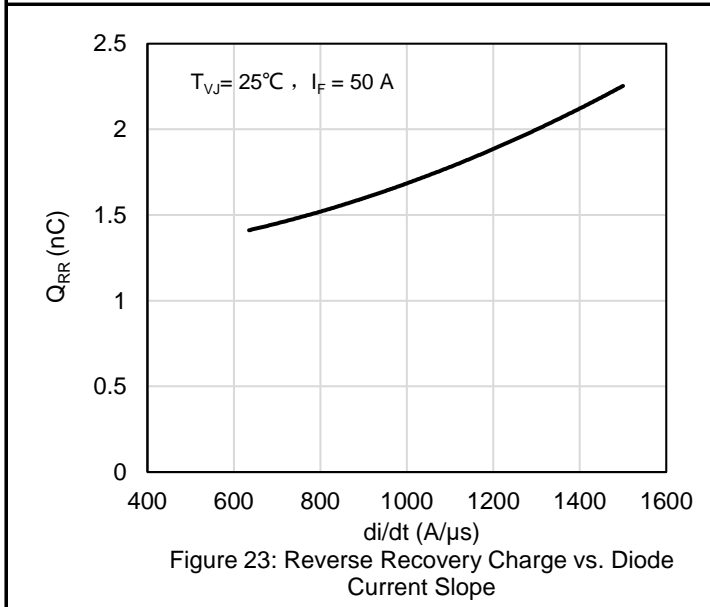
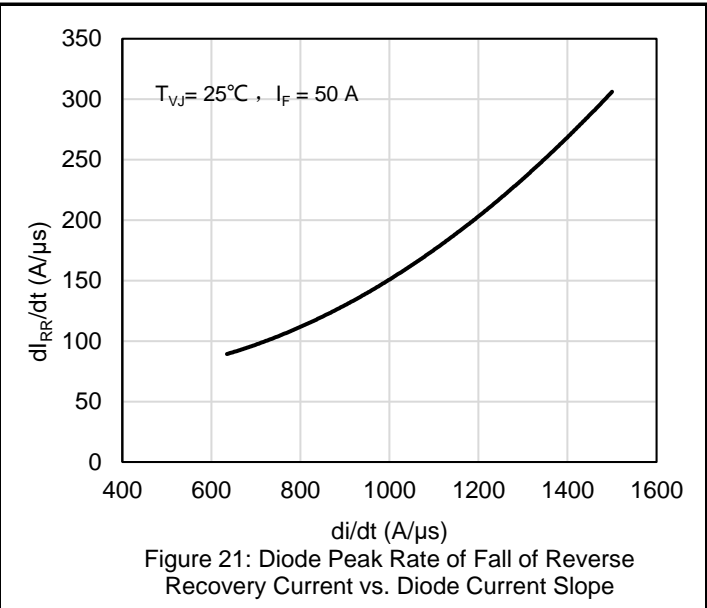
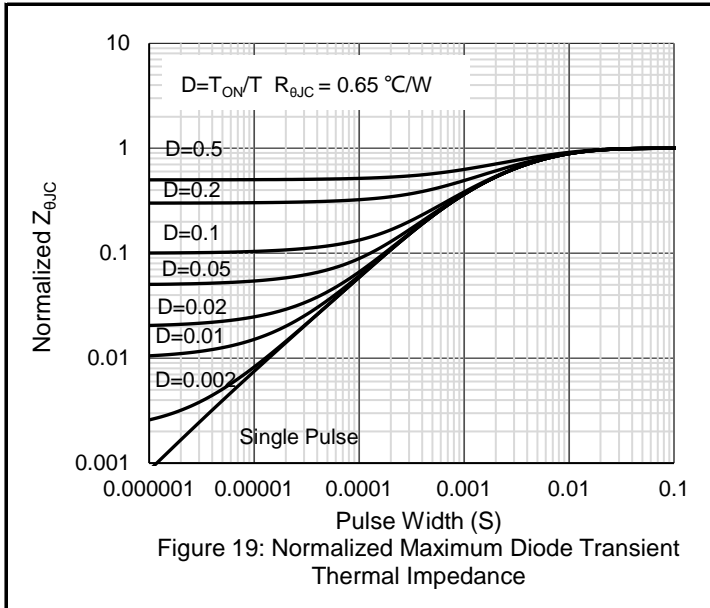

Test Circuit and Waveform

Switching Test Circuit & Waveforms

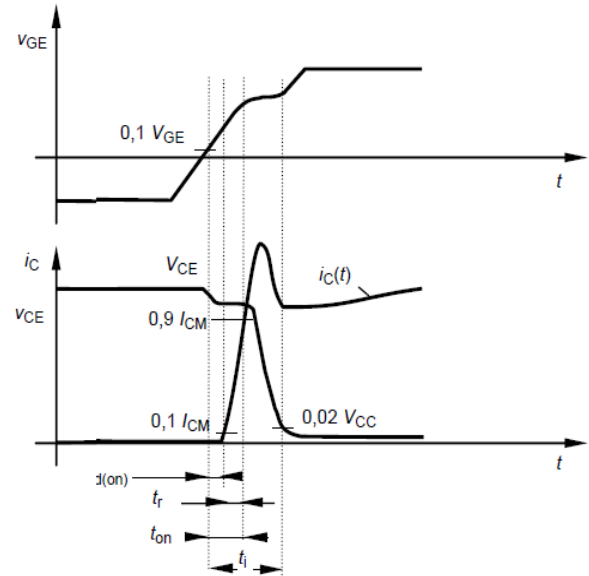
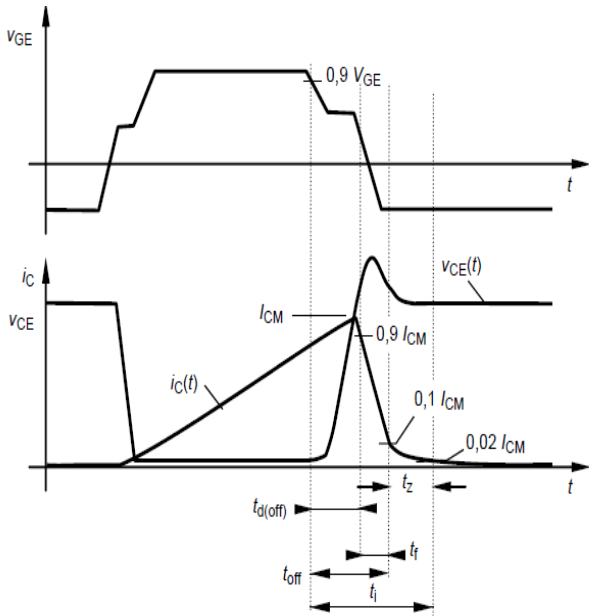

Diode Recovery Test Circuit & Waveforms

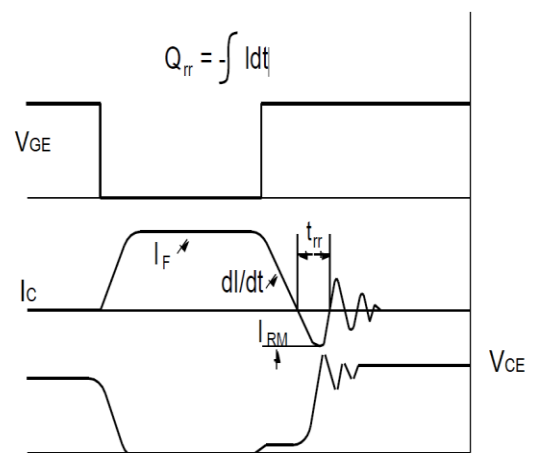
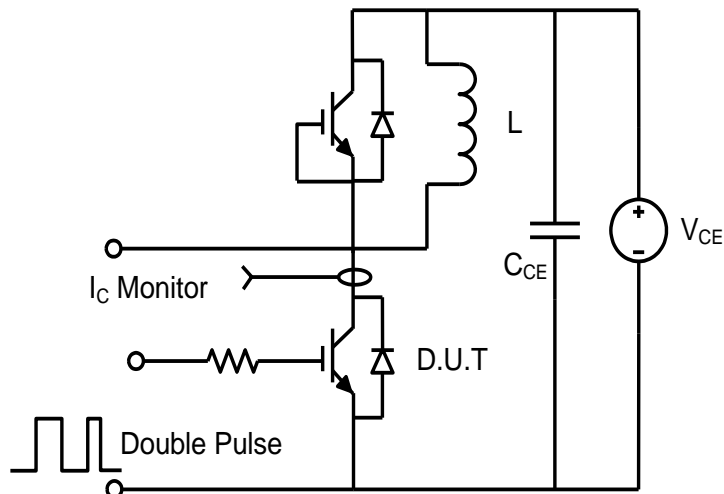

Package Outlines

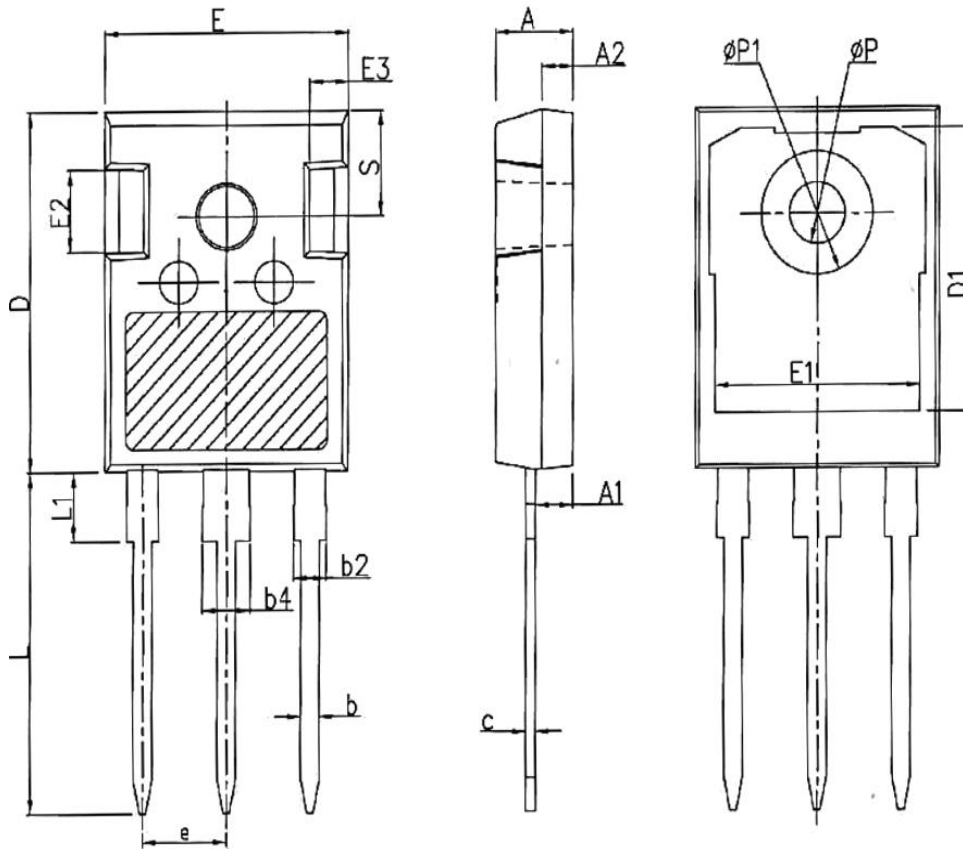

SYMBOL	mm		
	MIN	NOM	MAX
A	4.80	5.00	5.20
A1	2.21	2.41	2.59
A2	1.85	2.00	2.15
b	1.11	1.21	1.36
b2	1.91	2.01	2.21
b4	2.91	3.01	3.21
c	0.51	0.61	0.75
D	20.70	21.00	21.30
D1	16.25	16.55	16.85
E	15.50	15.80	16.10
E1	13.00	13.30	13.60
E2	4.80	5.00	5.20
E3	2.30	2.50	2.70
e	5.44BSC		
L	19.62	19.92	20.22
L1	-	-	4.30
ΦP	3.40	3.60	3.80
$\Phi P1$	-	-	7.30
S	6.15BSC		

Marking Information



B65A050WHS

XXXXXXXX

Note:

B65A050WHS = Product Name Code

XXXXXXXX = Date code

Contact ALKAIDSEMI sales for detail information

Revision History

Revision	Release Date	Remark
Rev.1.0	2023/3/10	Initial Release

Disclaimer

The information given in this document describes the independent performance of the product, but similar performance is not guaranteed under other working conditions, and cannot be guaranteed when installed with other products or equipment. To achieve the required performance of the product in actual scenarios, the customer should conduct a complete application test to assess the functionality of the product.

Alkaidsemi assumes no responsibility for equipment failures result from using products at values that exceed the ratings, operating conditions, or other parameters listed in the product specifications.

The product described in this specification is not applicable for aerospace or other applications which requires high reliability. Customers using or selling these products for use in medical, life-saving, or life-sustaining applications do so at their own risk and agree to fully indemnify.

Due to product or technical improvements, the information described or contained herein may be changed without prior notice.