

# 40V 0.7mohm N-channel SGT MOSFET

## AK1G4N007GAL

### Description:

This N channel SGT MOSFET has been designed to very low on-state resistance and maintain superior switching performance, especial for high efficiency power management applications.

### Features:

- Low  $R_{DS(ON)}$
- RoHS compliant
- Halogen-free

### Applications:

- Battery Management System
- Motor Drivers
- DC-DC Converter

### Key Performance Parameters:

Parameter	Value	Unit
$V_{DS}$	40	V
$R_{DS(ON), max} @ V_{GS} = 10 V$	0.7	m $\Omega$
$I_D$	345	A

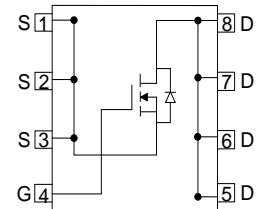
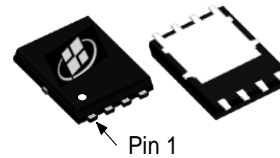

### Ordering Information:

Ordering Code	Package Type	Marking Code	Form	Packing
AK1G4N007GAL	PDFN5X6	1G4N007GAL	Tape Reel	5000 per reel

## Maximum Ratings ( $T_A = 25^\circ\text{C}$ unless otherwise noted)

Symbol	Parameter	Value	Units
$V_{DS}$	Drain-Source Voltage	40	V
$I_D$	Drain Current - Continuous ( $T_C = 25^\circ\text{C}$ ) <sup>(Note 1)</sup>	345	A
	Drain Current - Continuous ( $T_C = 100^\circ\text{C}$ )	218	A
$I_{DM}$	Drain Current - Pulsed <sup>(Note 2)</sup>	1380	A
$V_{GS}$	Gate-Source Voltage	$\pm 20$	V
$E_{AS}$	Single Pulsed Avalanche Energy <sup>(Note 3)</sup>	702	mJ
$P_D$	Power Dissipation ( $T_C = 25^\circ\text{C}$ )	139	W
$T_J, T_{STG}$	Operating and Storage Temperature Range	-55 to +150	$^\circ\text{C}$

## Thermal Characteristics

Symbol	Parameter	Value	Units
$R_{\theta JC}$	Thermal Resistance, Junction-to-Case, Steady-State	0.9	$^\circ\text{C}/\text{W}$
$R_{\theta JA}$	Thermal Resistance, Junction-to-Ambient, Steady State <sup>(Note 4)</sup>	45	$^\circ\text{C}/\text{W}$

### Notes:

1. The max drain current rating is silicon limited
2. Repetitive Rating: Pulse width limited by maximum junction temperature
3.  $L = 0.5 \text{ mH}$ ,  $V_{DD} = 20 \text{ V}$ ,  $I_{AS} = 53 \text{ A}$ ,  $R_g = 50 \Omega$ , Starting  $T_J = 25^\circ\text{C}$
4. Mount on minimum PCB layout

Electrical Characteristics ( $T_J = 25^\circ\text{C}$ unless otherwise noted)						
Symbol	Parameter	Test Conditions	Min	Typ	Max	Units
<b>Static Characteristics</b>						
$V_{(BR)DSS}$	Drain-Source Breakdown Voltage	$V_{GS} = 0\text{ V}, I_D = 250\ \mu\text{A}$	40			V
$I_{DSS}$	Zero Gate Voltage Drain Current	$V_{DS} = 40\text{ V}, V_{GS} = 0\text{ V},$			1	$\mu\text{A}$
$I_{GSS}$	Gate Leakage Current	$V_{GS} = \pm 20\text{ V}, V_{DS} = 0\text{ V}$			$\pm 100$	nA
$V_{GS(th)}$	Gate Threshold voltage	$V_{DS} = V_{GS}, I_D = 250\ \mu\text{A}$	1	1.85	3	V
$R_{DS(ON)}$	Drain-Source on-state resistance	$V_{GS} = 10\text{ V}, I_D = 50\text{ A}$		0.6	0.7	m $\Omega$
		$V_{GS} = 4.5\text{ V}, I_D = 50\text{ A}$		1.1	1.45	
<b>Dynamic Characteristics</b>						
$C_{iss}$	Input Capacitance	$V_{DS} = 20\text{ V}, V_{GS} = 0\text{ V},$ $f = 1\text{ MHz}$		6900		pF
$C_{oss}$	Output Capacitance			2800		pF
$C_{rss}$	Reverse Transfer Capacitance			48		pF
$R_g$	Gate Resistance	$f = 1\text{ MHz}$		1.5		$\Omega$
<b>Switching Characteristics</b>						
$t_{d(on)}$	Turn On Delay Time	$V_{DD} = 20\text{ V}, R_L = 1\ \Omega,$ $V_{GS} = 10\text{ V}, R_G = 1.1\ \Omega$		17		ns
$t_r$	Rise Time			35		ns
$t_{d(off)}$	Turn Off Delay Time			45		ns
$t_f$	Fall Time			20		ns
$Q_g$	Total Gate Charge	$V_{DD} = 20\text{ V}, I_D = 20\text{ A},$ $V_{GS} = 10\text{ V}$		98		nC
$Q_{gs}$	Gate-Source Charge			22		nC
$Q_{gd}$	Gate-Drain Charge			16		nC
<b>Drain-Source Diode Characteristics and Maximum Ratings</b>						
$I_S$	Maximum Continuous Body-Diode Forward Current				139	A
$I_{SM}$	Maximum Pulsed Body-Diode Forward Current				1380	A
$V_{SD}$	Diode Forward Voltage	$V_{GS} = 0\text{ V}, I_S = 1\text{ A}$		0.65	1	V
$t_{rr}$	Reverse recovery time	$V_{DD} = 20\text{ V}, I_D = 20\text{ A},$ $di/dt = 100\text{ A}/\mu\text{S}$		100		ns
$Q_{rr}$	Reverse recovery charge			150		nC
$I_{rrm}$	Peak Reverse Recovery Current			2.5		A

# Electrical Characteristics Diagrams

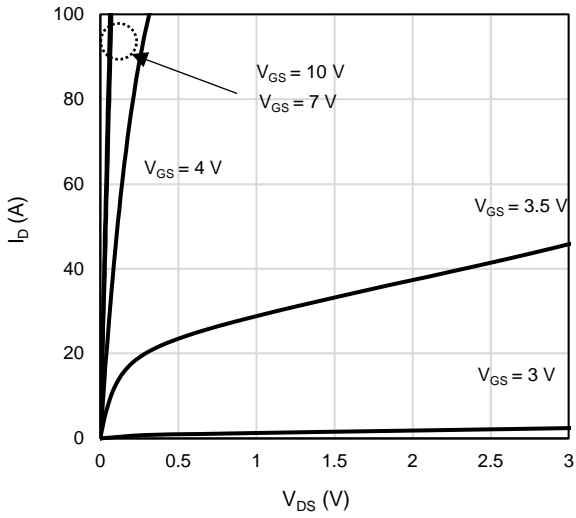

Figure 1: On-Region Characteristics

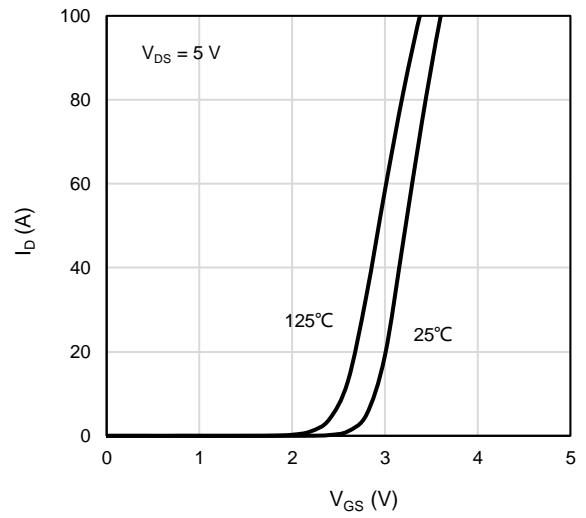

Figure 2: Transfer Characteristics

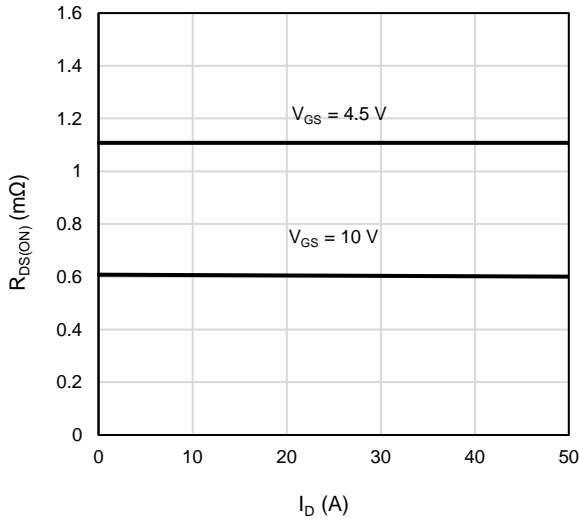

Figure 3: On-Resistance vs. Drain Current and Gate Voltage

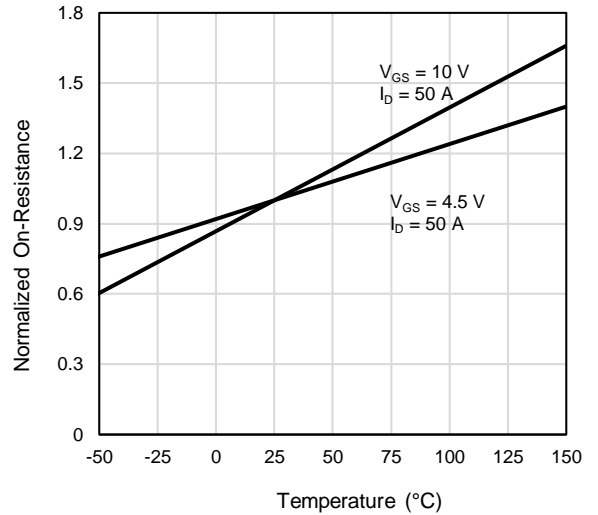

Figure 4: On-Resistance vs. Junction Temperature

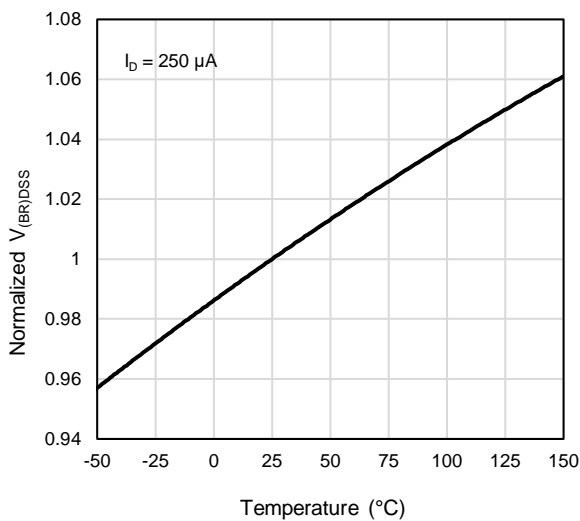

Figure 5: Breakdown Voltage vs. Junction Temperature

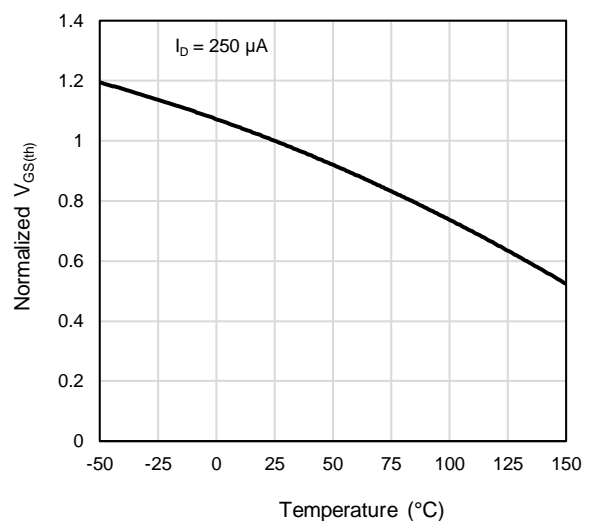

Figure 6: Threshold Voltage vs. Junction Temperature

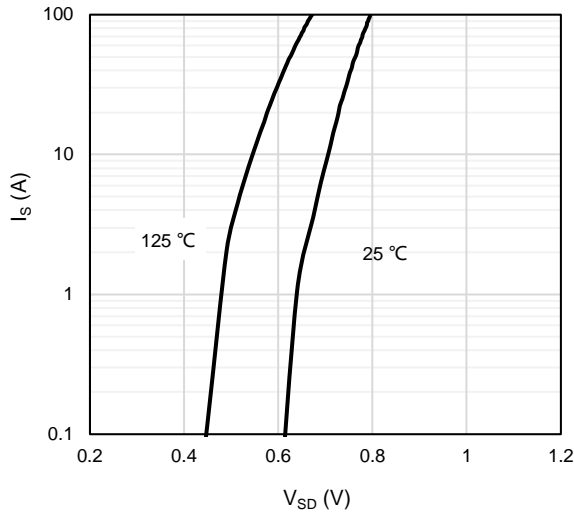

Figure 7: Body-Diode Characteristics

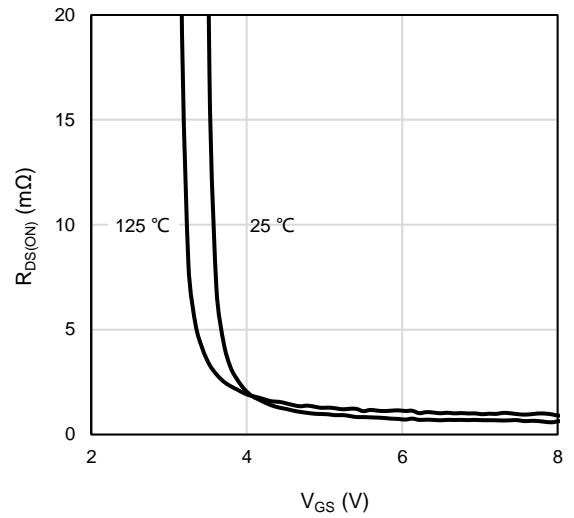

Figure 8: On-Resistance vs. Gate-Source Voltage

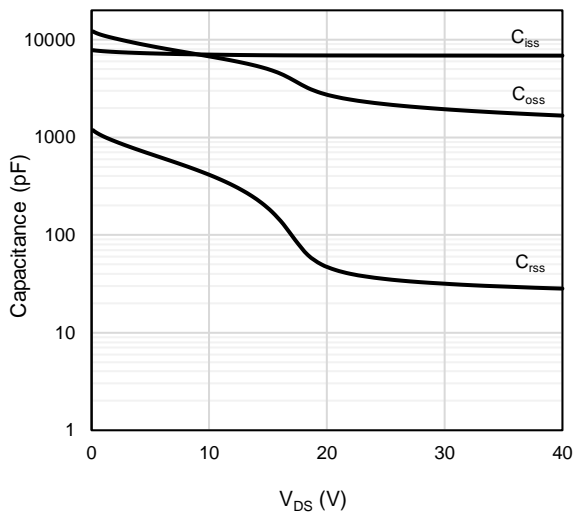

Figure 9: Capacitance Characteristics

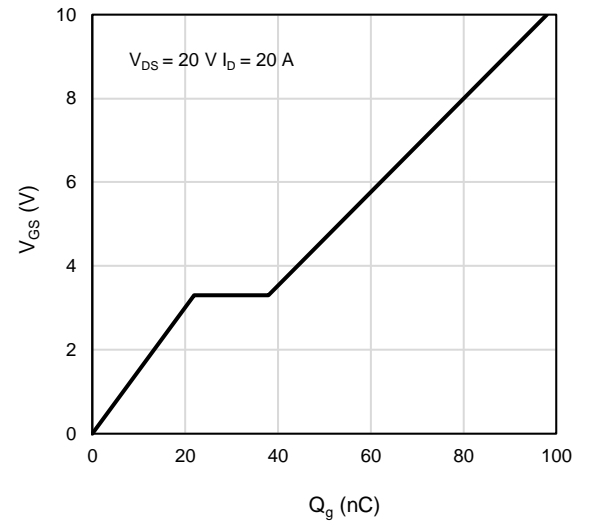

Figure 10: Gate-Charge Characteristics

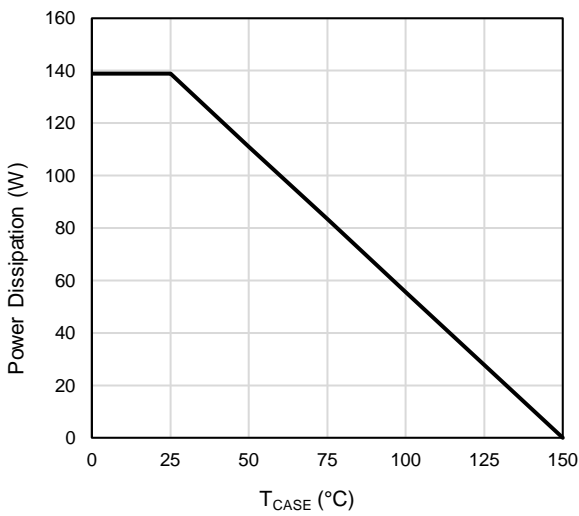

Figure 11: Power De-rating

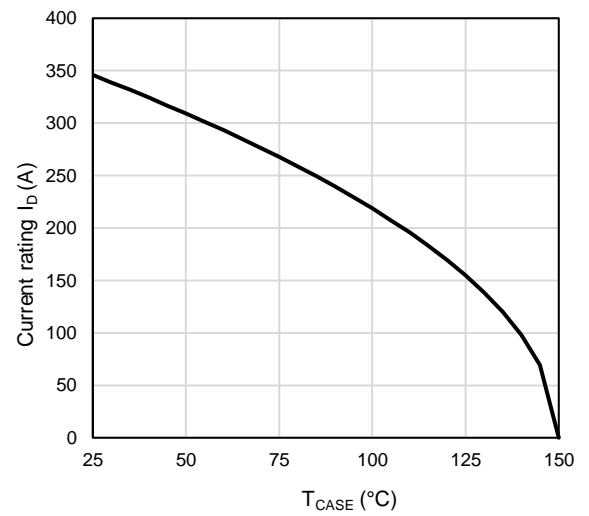

Figure 12: Current De-rating

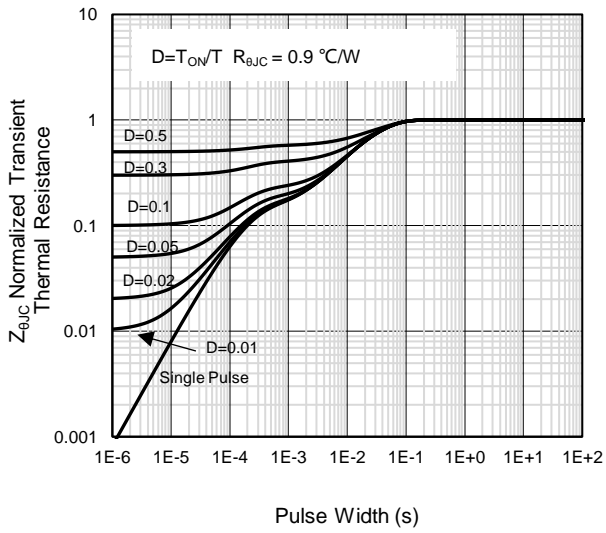

Figure 13: Normalized Maximum Transient Thermal Impedance

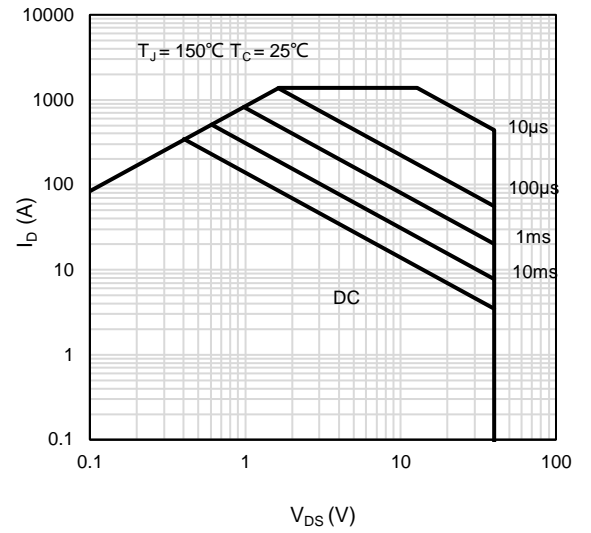
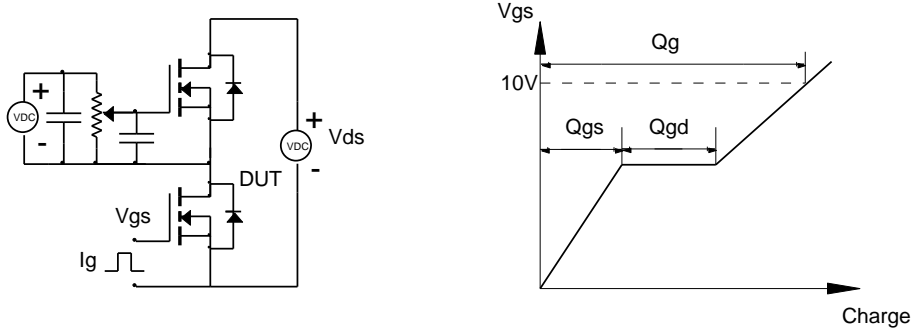

Figure 14: Maximum Forward Biased Safe Operating Area

# Test Circuit and Waveform

Gate Charge Test Circuit & Waveform



Resistive Switching Test Circuit & Waveforms

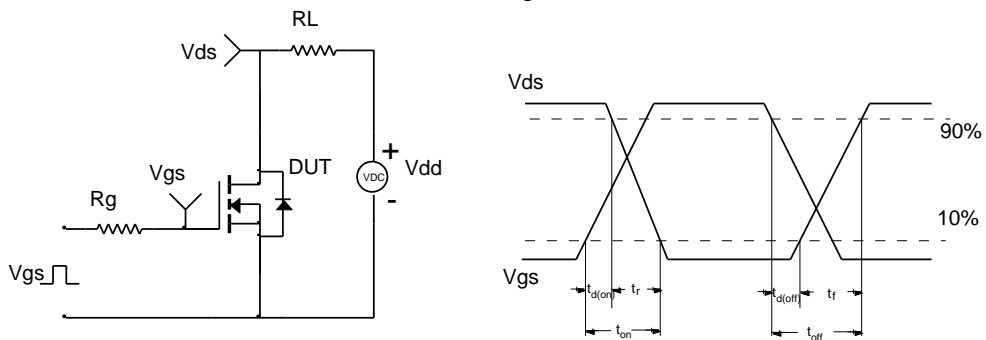

Unclamped Inductive Switching (UIS) Test Circuit & Waveforms

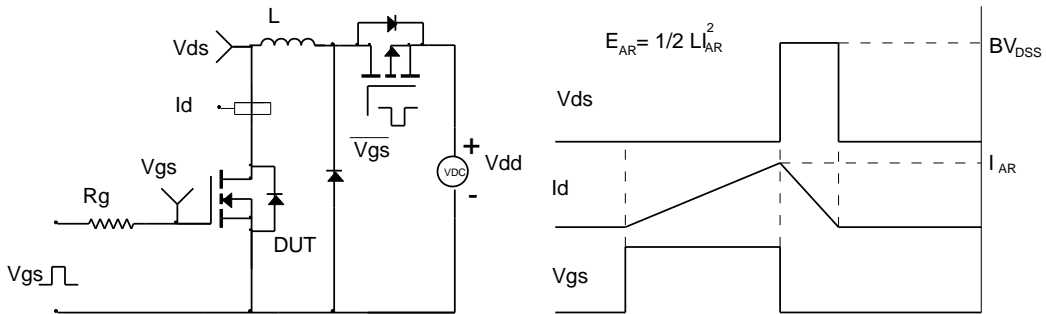

Diode Recovery Test Circuit & Waveforms

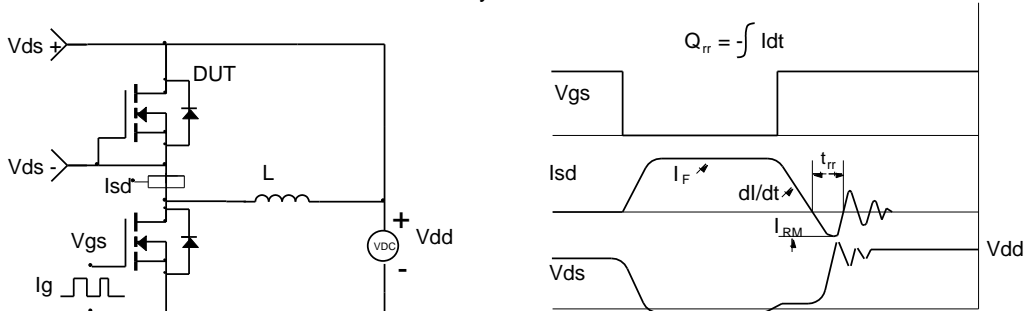

Package Outlines

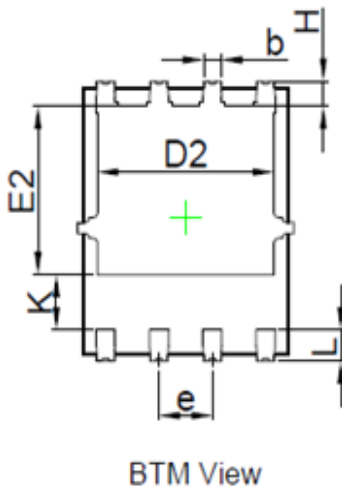
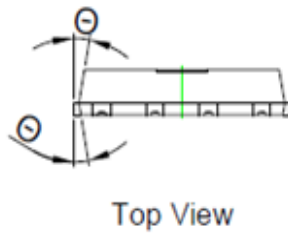
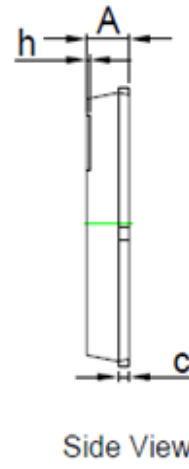
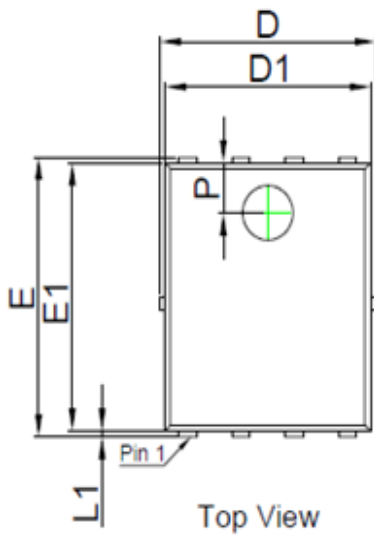

SYMBOL	MIN	NOM	MAX
A	0.90	1.00	1.10
b	0.32	0.42	0.52
c	0.21	0.25	0.34
D	5.00	5.15	5.30
D1	4.80	4.90	5.00
D2	4.10	4.20	4.30
e	1.27BSC		
E	6.00	6.15	6.30
E1	5.80	5.90	6.00
E2	3.60	3.70	3.80
H	0.45	0.55	0.65
h	-	-	0.10
K	1.17	-	-
L	0.58	0.68	0.78
L1	0.05	0.13	0.21
θ	8°	10°	12°
P	1.05	1.10	1.15

Unit in mm



### Marking Information

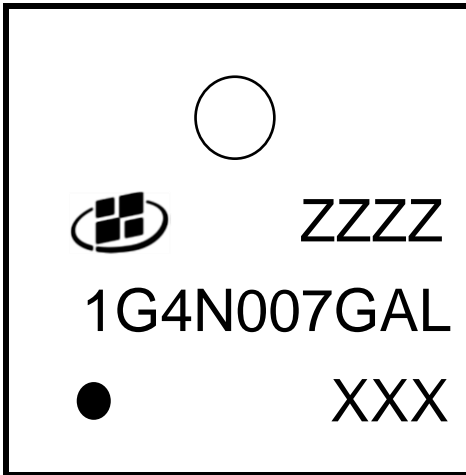

**Note:**

1G4N007GAL = Product Name Code

ZZZZ = Date code

XXX = Date code

Contact ALKAIDSEMI sales for detail information

### Tape & Reel Information

**REEL DIMENSIONS**

**TAPE DIMENSIONS**

A0: Dimension designed to accommodate the component width  
 B0: Dimension designed to accommodate the component length  
 K0: Dimension designed to accommodate the component thickness  
 W: Overall width of the carrier tape  
 P0: Pitch between successive cavity centers and sprocket hole  
 P1: Pitch between successive cavity centers  
 P2: Pitch between sprocket hole  
 T: Tape material thickness  
 D1: Reel Diameter  
 W1: Reel Width

DIMENSIONS										(Unit: mm)	
Reel	D1	W1								Material	
	330	12.5								Hips	
Tape	P0	P1	P2	W	A0	B0	K0	T	Pin 1 Quadrant	Material	
	4	8	2	12	6.3	5.3	1.2	0.25	Q1	PC	

All dimensions are nominal

---

## Revision History

Revision	Released	Remark
Rev.1.0	2023	preliminary

### Disclaimer

The information given in this document describes the independent performance of the product, but similar performance is not guaranteed under other working conditions, and cannot be guaranteed when installed with other products or equipment. To achieve the required performance of the product in actual scenarios, the customer should conduct a complete application test to assess the functionality of the product.

Alkaidsemi assumes no responsibility for equipment failures result from using products at values that exceed the ratings, operating conditions, or other parameters listed in the product specifications.

The product described in this specification is not applicable for aerospace or other applications which requires high reliability. Customers using or selling these products for use in medical, life-saving, or life-sustaining applications do so at their own risk and agree to fully indemnify.

Due to product or technical improvements, the information described or contained herein may be changed without prior notice.