

1200V 40mohm Silicon Carbide Power MOSFET AKCK2M040WAM

Features:

- Low on-resistance
- Fast switching speed with low capacitances
- Fast intrinsic diode with low reverse recovery (Q_{RR})
- Halogen-free, RoHS compliant ^(Note 1)

Applications:

- Motor drives
- DC/DC converters
- Switched mode power supplies
- Solar inverters

Key Performance Parameters:

Parameter	Value	Unit
V_{DS}	1200	V
$R_{DSON, TYP} @ V_{GS} = 15 V$	40	m Ω
$R_{DSON, TYP} @ V_{GS} = 18 V$	34	m Ω
I_D	65	A
P_D	375	W

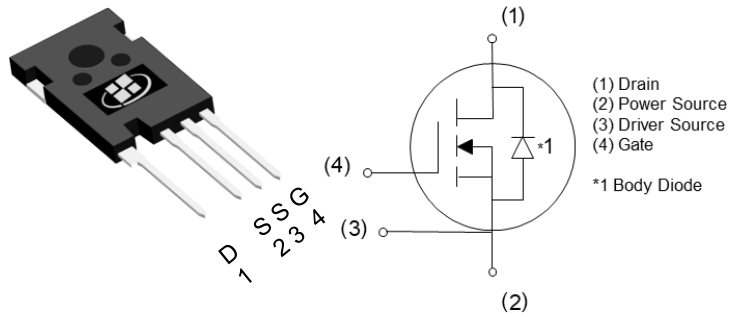

Ordering Information:

Ordering Code	Package Type	Marking Code	Form	Packing
AKCK2M040WAM	TO-247-4L	CK2M040WAM	Tube	300 per box

Notes:

1. Contact ALKAIDSEMI sales for detail information

Maximum Ratings ($T_A = 25^\circ\text{C}$ unless otherwise noted)

Symbol	Parameter	Value	Units
V_{DS}	Drain-Source Voltage	1200	V
I_D	Drain Current - Continuous ($T_C = 25^\circ\text{C}$) ^(Note 1)	65	A
	Drain Current - Continuous ($T_C = 100^\circ\text{C}$) ^(Note 1)	48	A
I_{DM}	Drain Current - Pulsed ^(Note 2)	162	A
V_{GS}	Gate-Source Voltage (dynamic)	-10/+22	V
V_{GS}	Gate-Source Voltage (static)	-6/+18	V
P_D	Power Dissipation ($T_C = 25^\circ\text{C}$)	375	W
T_J, T_{STG}	Operating and Storage Temperature Range	-55 to +175	$^\circ\text{C}$

Thermal Characteristics

Symbol	Parameter	Value	Units
$R_{\theta JC}$	Thermal Resistance, Junction-to-Case, Steady-State	0.4	$^\circ\text{C}/\text{W}$
$R_{\theta JA}$	Thermal Resistance, Junction-to-Ambient, Steady-State	40	$^\circ\text{C}/\text{W}$

Notes:

1. The max drain current limited by maximum junction temperature
2. Pulse width is limited by safe operating area

Electrical Characteristics ($T_J = 25^\circ\text{C}$ unless otherwise noted)						
Symbol	Parameter	Test Conditions	Min	Typ	Max	Units
Static Characteristics						
BV_{DSS}	Drain-Source Breakdown Voltage	$V_{GS} = 0\text{ V}, I_D = 100\ \mu\text{A}$	1200			V
I_{DSS}	Zero Gate Voltage Drain Current	$V_{DS} = 1200\text{ V}, V_{GS} = 0\text{ V}$		5	50	μA
I_{GSS}	Gate Leakage Current	$V_{GS} = +15\text{ V}, V_{DS} = 0\text{ V}$			100	nA
		$V_{GS} = -4\text{ V}, V_{DS} = 0\text{ V}$			-100	nA
$V_{GS(TH)}$	Gate Threshold voltage	$V_{DS} = V_{GS}, I_D = 9.5\text{ mA}$	2	2.8	4	V
		$V_{DS} = V_{GS}, I_D = 9.5\text{ mA}, T_J = 175^\circ\text{C}$		1.9		V
$R_{DS(ON)}$	Drain-Source on-state resistance	$V_{GS} = 15\text{ V}, I_D = 33.3\text{ A}$		40	54	m Ω
		$V_{GS} = 15\text{ V}, I_D = 33.3\text{ A}, T_J = 175^\circ\text{C}$		64		m Ω
		$V_{GS} = 18\text{ V}, I_D = 33.3\text{ A}$		34	40	m Ω
		$V_{GS} = 18\text{ V}, I_D = 33.3\text{ A}, T_J = 175^\circ\text{C}$		60		m Ω
G_{FS}	Forward Transconductance	$V_{DS} = 20\text{ V}, I_D = 33.3\text{ A}$		16		S
		$V_{DS} = 20\text{ V}, I_D = 33.3\text{ A}, T_J = 175^\circ\text{C}$		17		S
Dynamic Characteristics						
C_{ISS}	Input Capacitance	$V_{DS} = 800\text{ V}, V_{GS} = 0\text{ V}, F = 100\text{ kHz}, V_{AC} = 25\text{ mV}$		2540		pF
C_{OSS}	Output Capacitance			105		pF
C_{RSS}	Reverse Transfer Capacitance			11		pF
E_{OSS}	C_{OSS} Stored Energy			45		μJ
R_G	Gate Resistance	$F = 1\text{ MHz}, V_{AC} = 25\text{ mV}$		1.6		Ω
Q_{GS}	Gate-Source Charge	$V_{DS} = 800\text{ V}, I_D = 33.3\text{ A}, V_{GS} = -4/+15\text{ V}$		34		nC
Q_{GD}	Gate-Drain Charge			52		nC
Q_G	Total Gate Charge			138		nC

Switching Characteristics

Symbol	Parameter	Test Conditions	Min	Typ	Max	Units	
$T_{D(ON)}$	Turn On Delay Time	$V_{DD} = 800\text{ V}$, $I_D = 33.3\text{ A}$, $V_{GS} = -4/+15\text{ V}$, $R_{G,EXT} = 2.5\ \Omega$ $L = 99\ \mu\text{H}$ Diode: Body Diode at $V_{GS} = -5\text{ V}$		36		ns	
T_R	Rise Time			16		ns	
$T_{D(OFF)}$	Turn Off Delay Time			11.5		ns	
T_F	Fall Time			11.5		ns	
E_{ON}	Turn On Energy				563		μJ
E_{OFF}	Turn Off Energy				83.3		μJ
$T_{D(ON)}$	Turn On Delay Time	$V_{DD} = 800\text{ V}$, $I_D = 33.3\text{ A}$, $V_{GS} = -4/+15\text{ V}$, $R_{G,EXT} = 2.5\ \Omega$ $L = 99\ \mu\text{H}$ Diode: SiC Diode at $V_{GS} = -5\text{ V}$		36.5		ns	
T_R	Rise Time			15		ns	
$T_{D(OFF)}$	Turn Off Delay Time			11.5		ns	
T_F	Fall Time			10.5		ns	
E_{ON}	Turn On Energy				470		μJ
E_{OFF}	Turn Off Energy				90		μJ

Drain-Source Diode Characteristics ($T_J = 25\text{ }^\circ\text{C}$ unless otherwise noted)

I_S	Maximum Continuous Drain-Source Diode Forward Current				65	A
I_{SM}	Maximum Pulsed Drain-Source Diode Forward Current				162	A
V_{SD}	Diode Forward Voltage	$V_{GS} = -4\text{ V}$, $I_{SD} = 20\text{ A}$		4.1		V
		$V_{GS} = -4\text{ V}$, $I_{SD} = 20\text{ A}$, $T_J = 175\text{ }^\circ\text{C}$		3.6		V
I_{RM}	Peak Reverse Recovery Current	$V_{GS} = -4\text{ V}$, $I_{SD} = 33.3\text{ A}$, $V_R = 800\text{ V}$, $di/dt = 650\text{ A}/\mu\text{S}$		6.5		A
T_{RR}	Reverse Recovery Time			22.5		ns
Q_{RR}	Reverse Recovery Charge				79	

Electrical Characteristics Diagrams

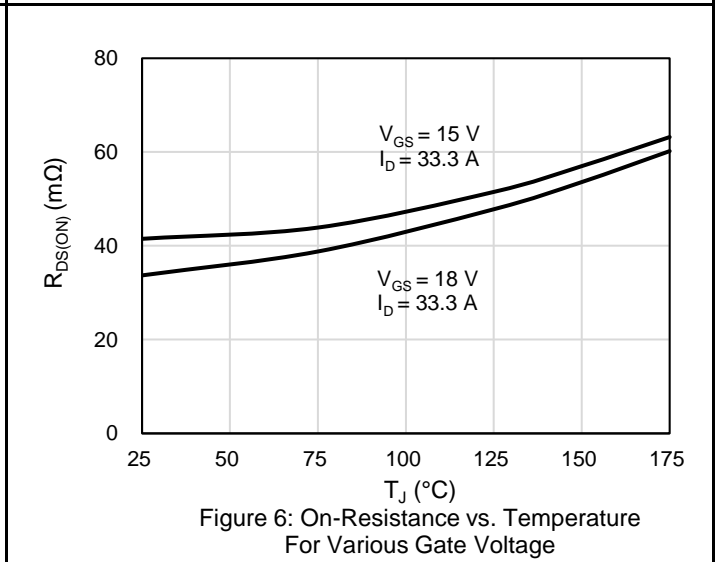
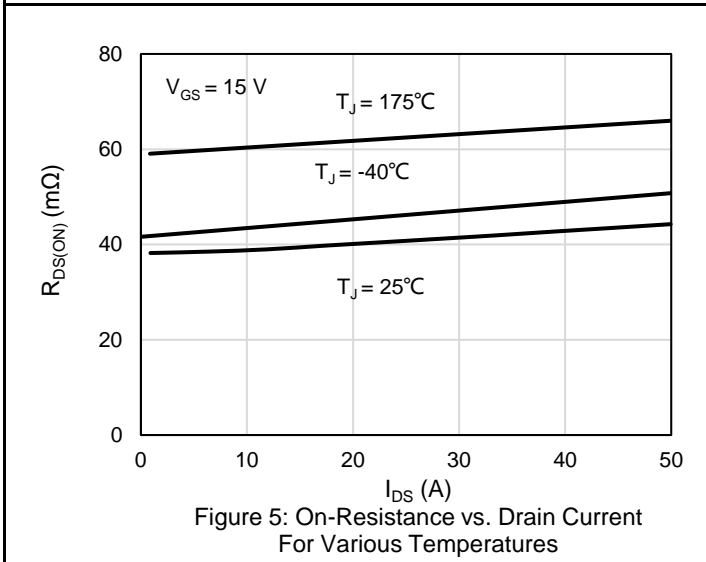
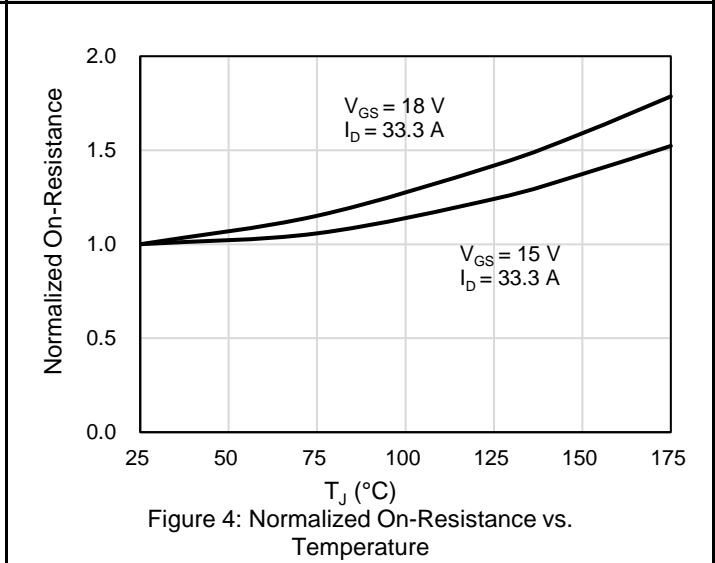
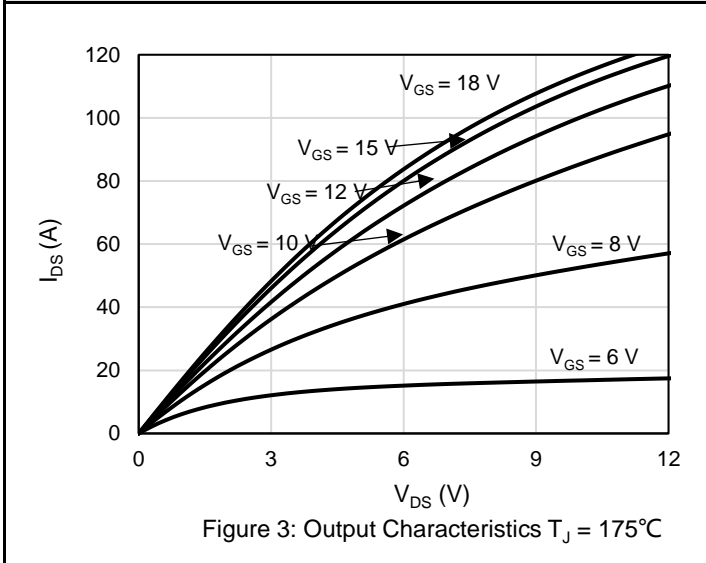
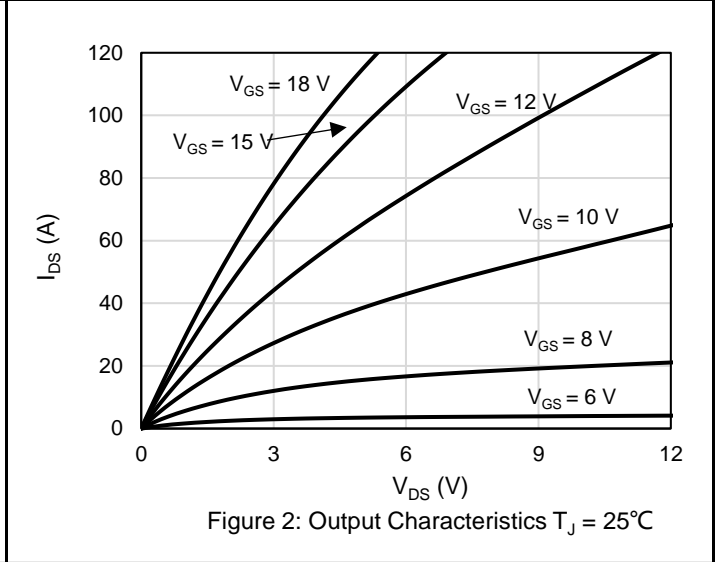
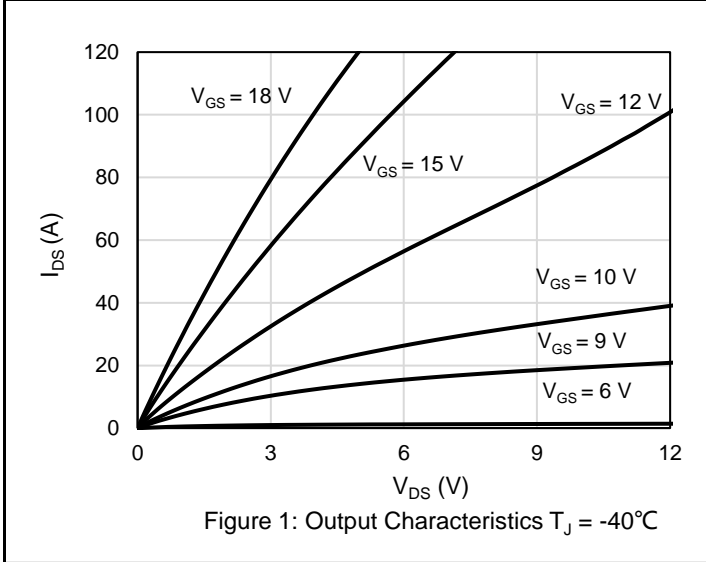

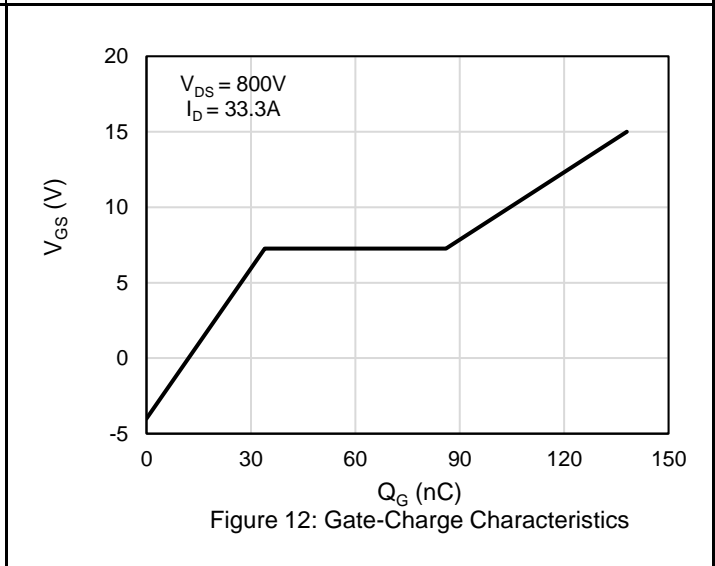
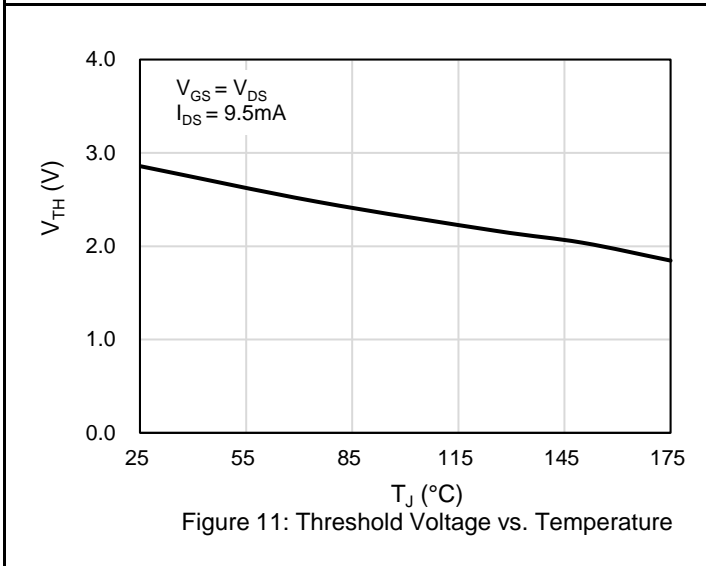
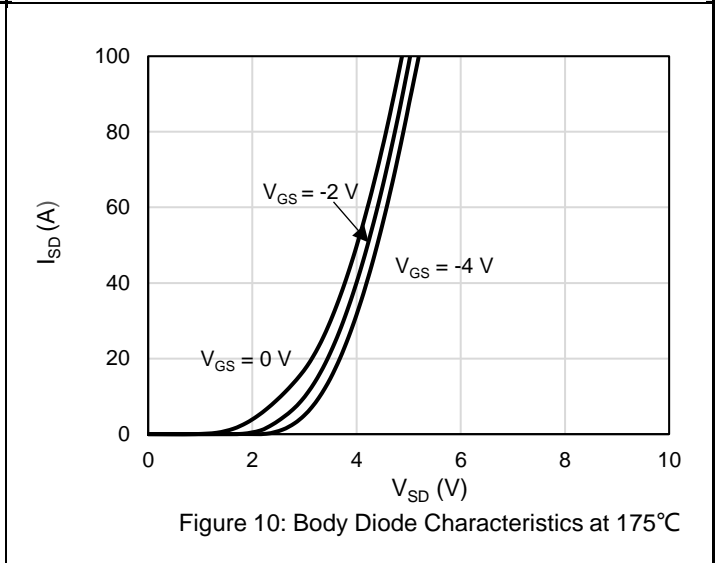
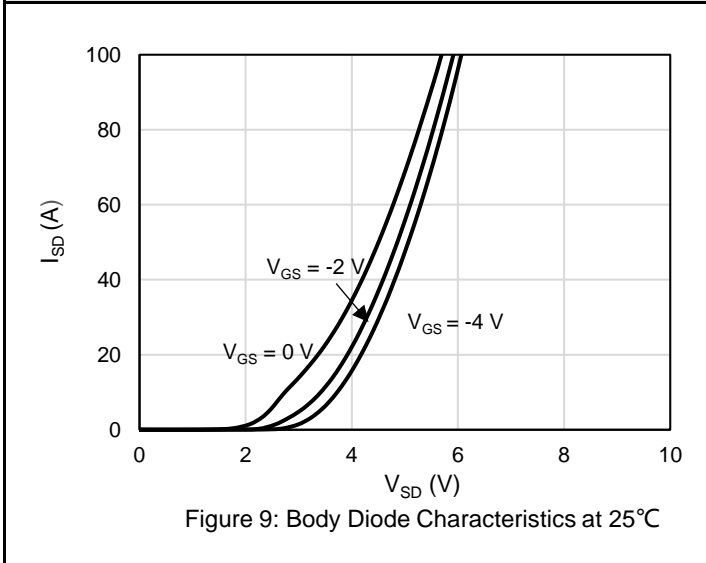
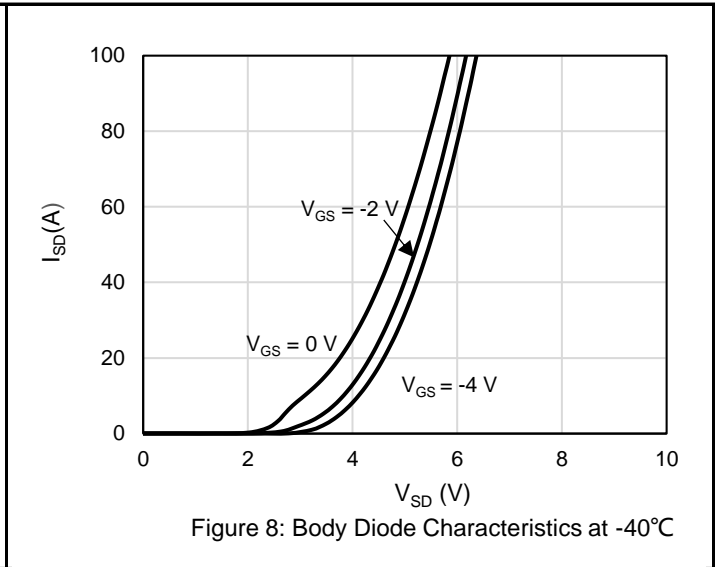
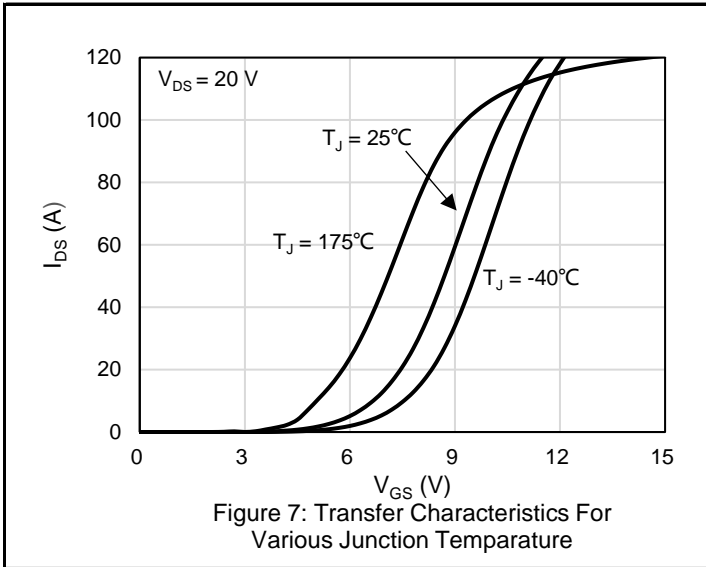

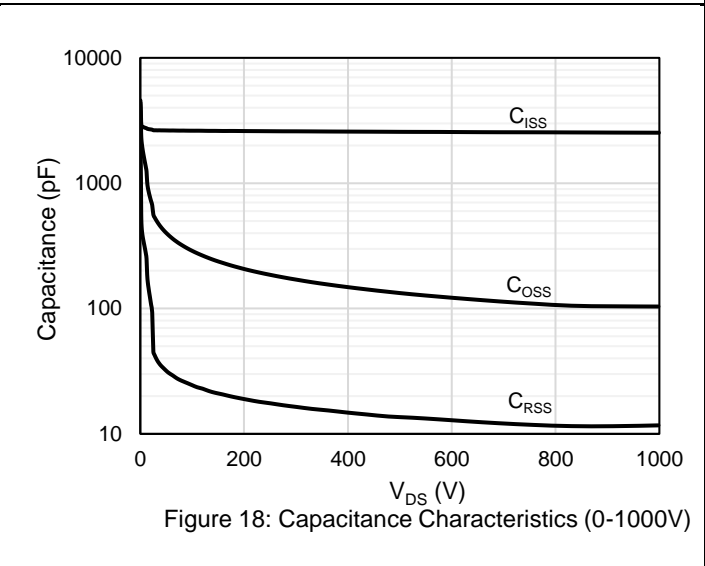
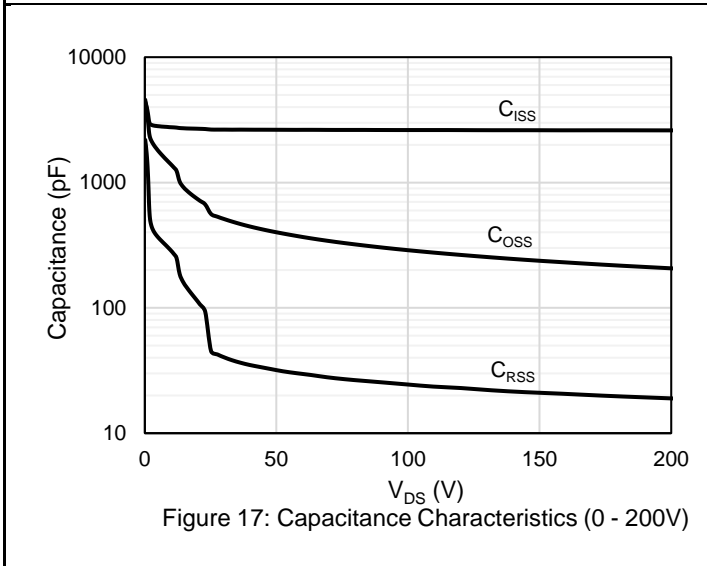
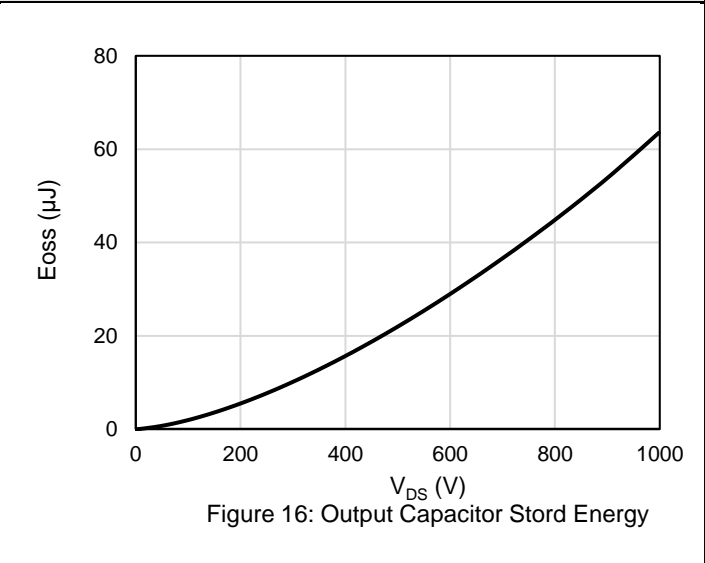
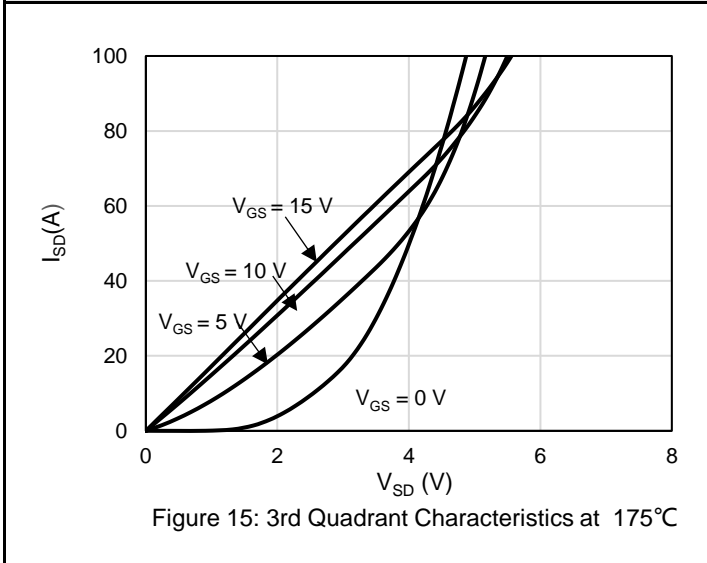
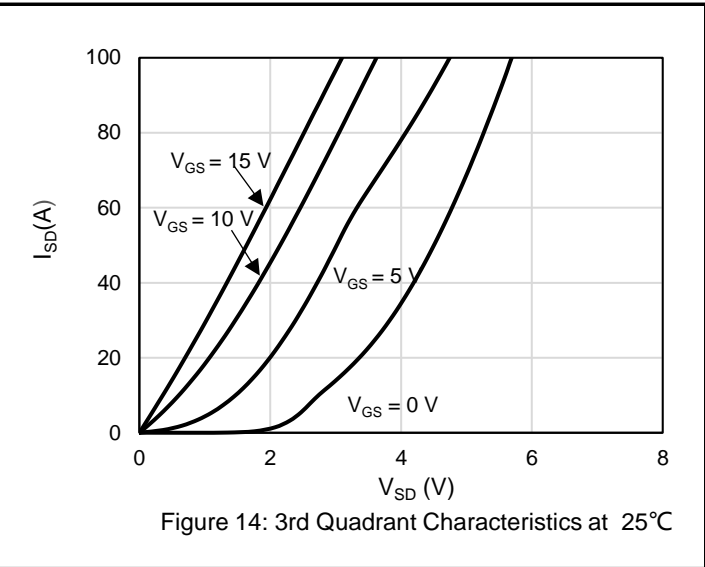
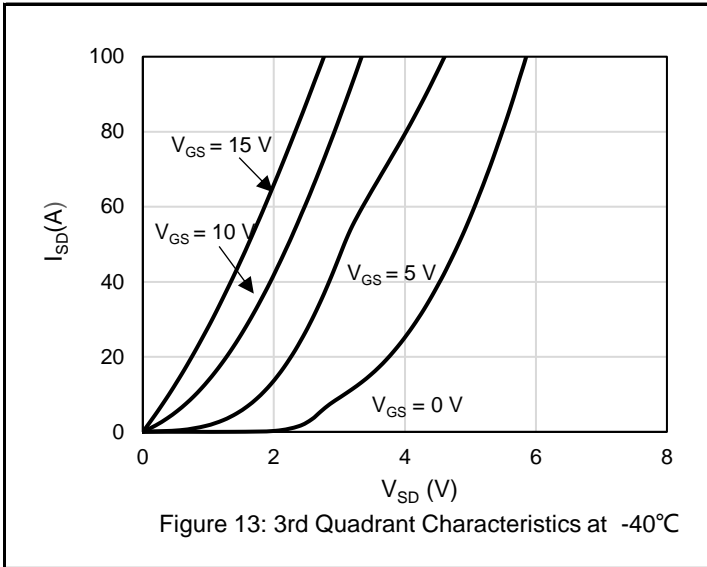

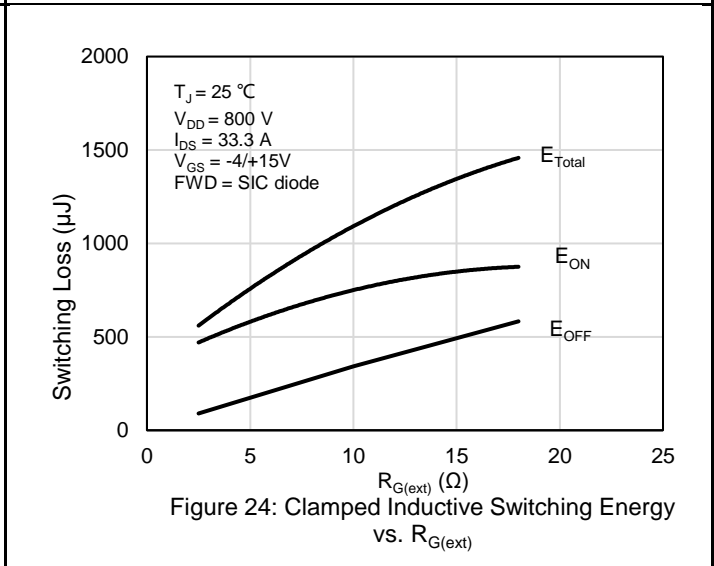
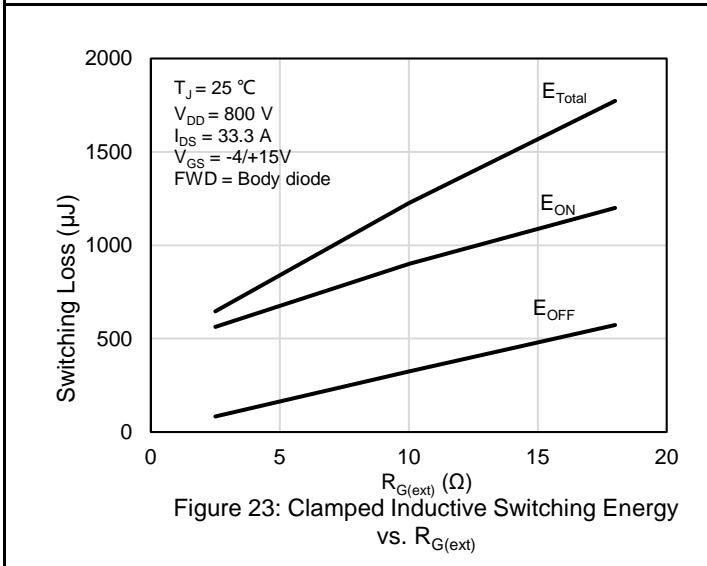
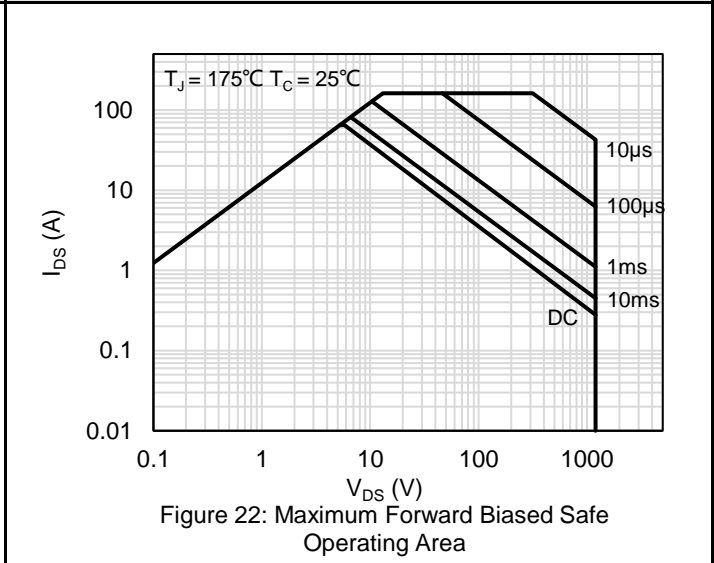
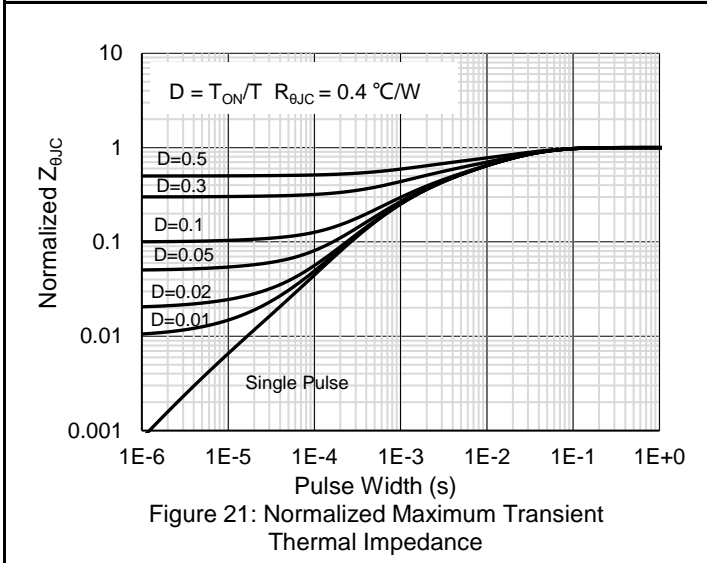
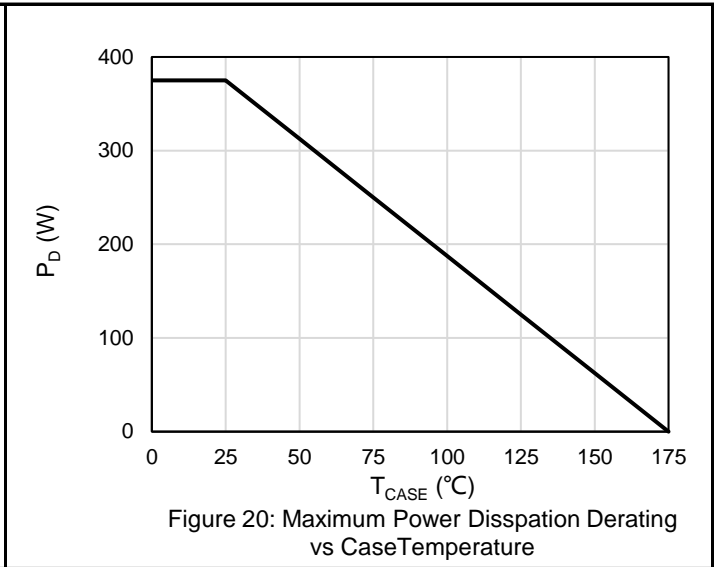
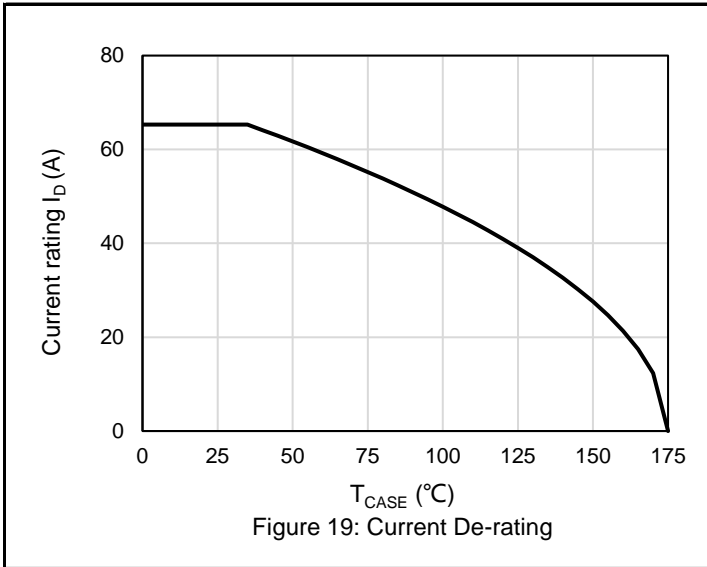

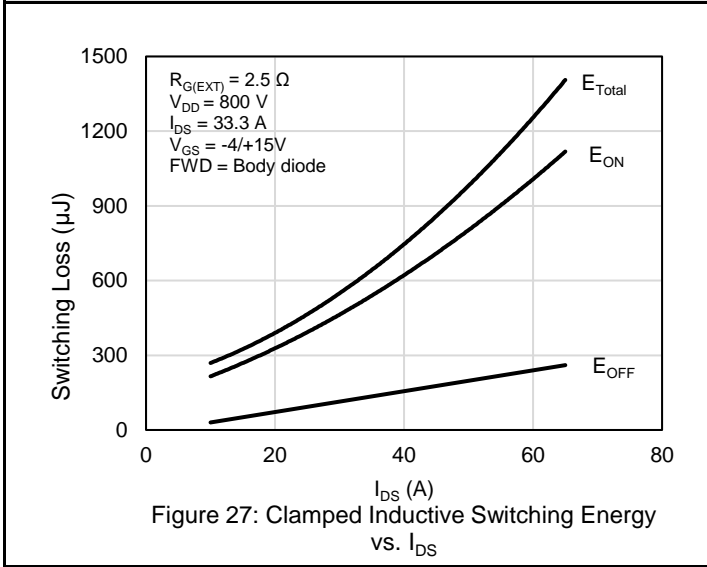
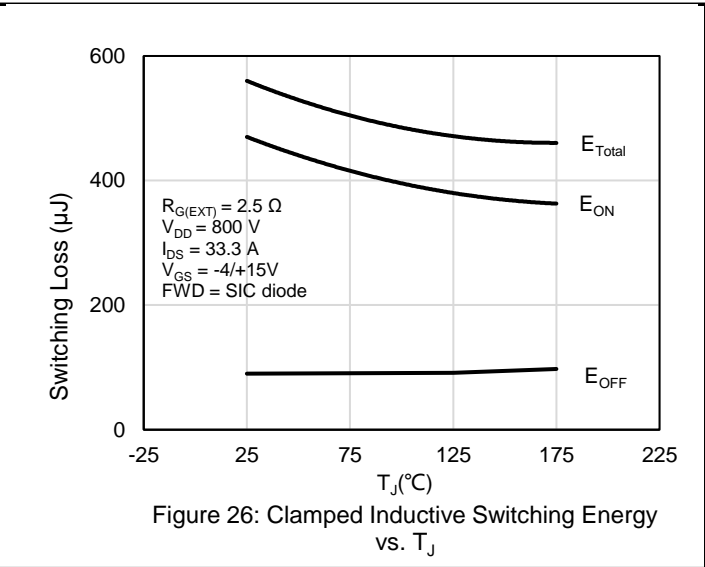
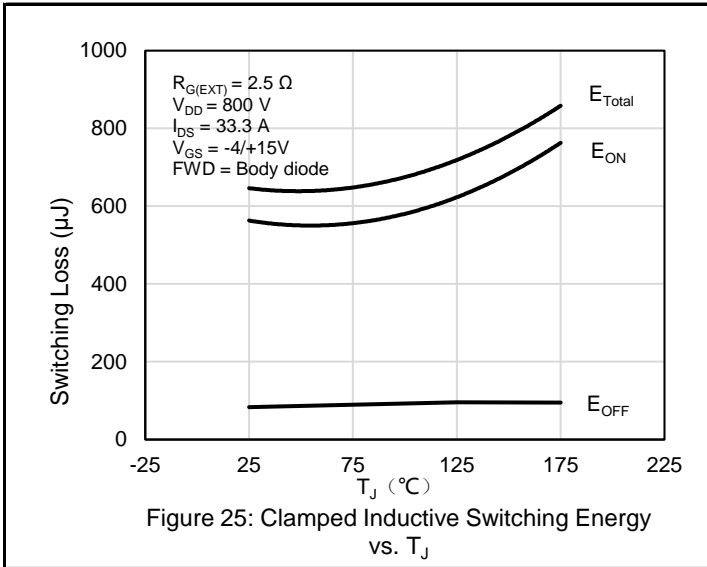

Test Circuit and Waveform

Gate Charge Test Circuit & Waveform

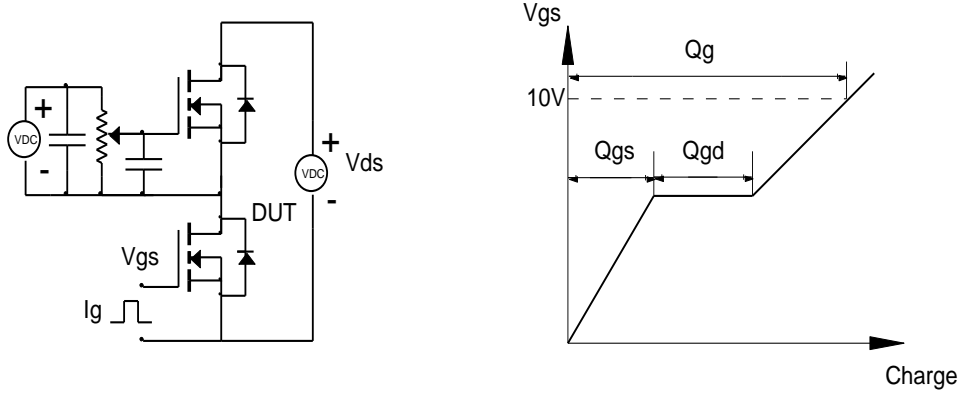

Clamped Inductive Switching Test Circuit & Waveforms

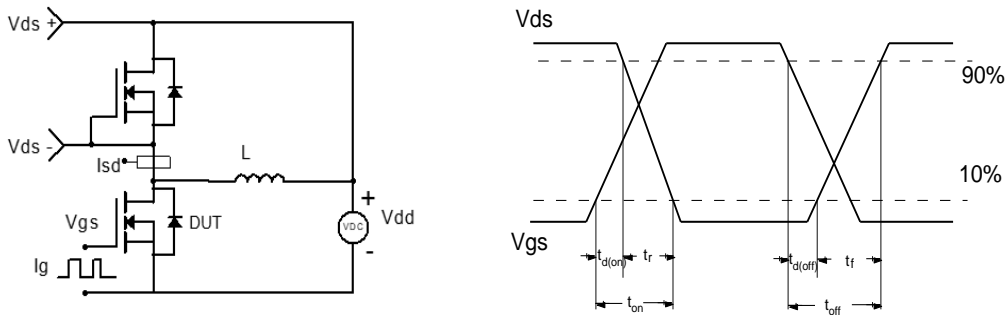

Diode Recovery Test Circuit & Waveforms

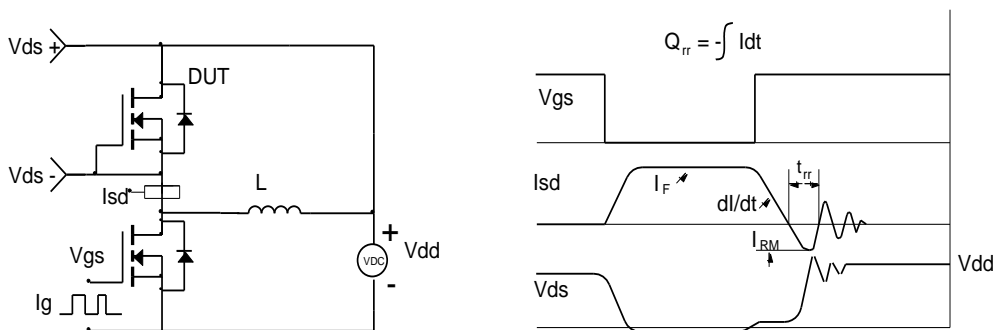

Package Outlines

TO-247-4L PKG Outlines

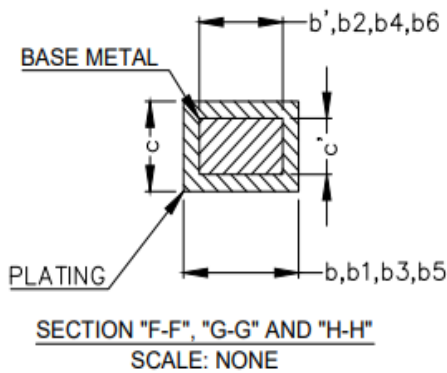
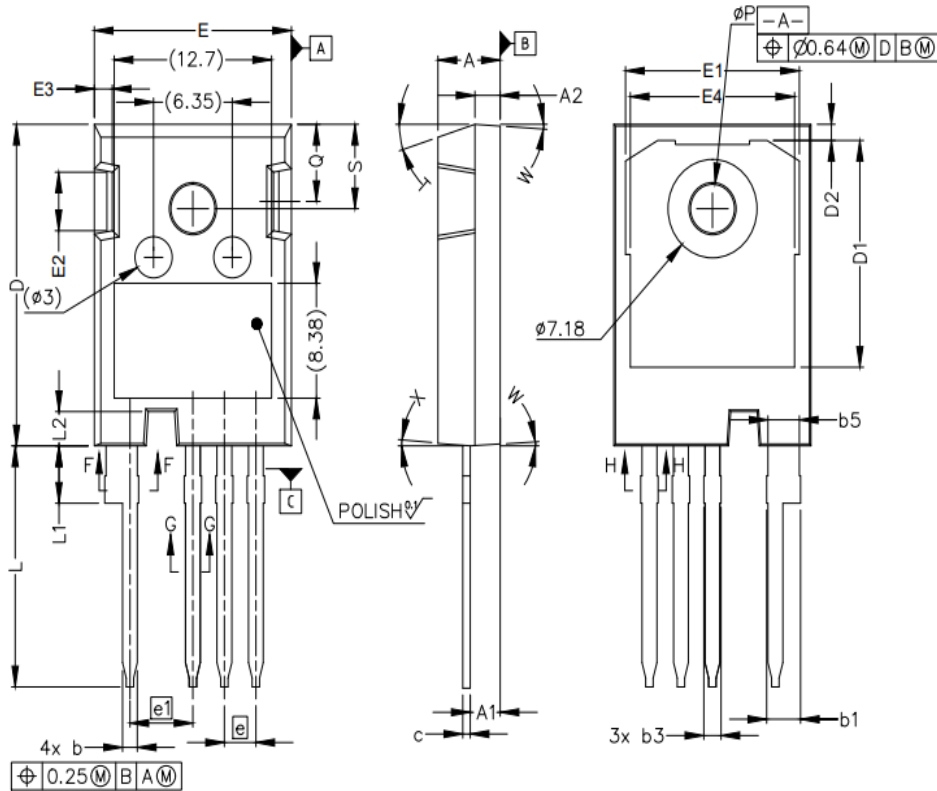

SYMBOL	MILLIMETERS	
	MIN	MAX
A	4.83	5.21
A1	2.29	2.54
A2	1.91	2.16
b'	1.07	1.28
b	1.07	1.33
b1	2.39	2.94
b2	2.39	2.84
b3	1.07	1.60
b4	1.07	1.50
b5	2.39	2.69
b6	2.39	2.64
c'	0.55	0.65
c	0.55	0.68
D	23.30	23.60
D1	16.25	17.65
D2	0.95	1.25
E	15.75	16.13
E1	13.10	14.15
E2	3.68	5.10
E3	1.00	1.90
E4	12.38	13.43
e	2.54 BSC	
e1	5.08 BSC	
N	4	
L	17.31	17.82
L1	3.97	4.37
L2	2.35	2.65
ϕP	3.51	3.65
Q	5.49	6.00
S	6.04	6.30
T	17.5° REF.	
W	3.5° REF.	
X	4° REF.	

Marking Information

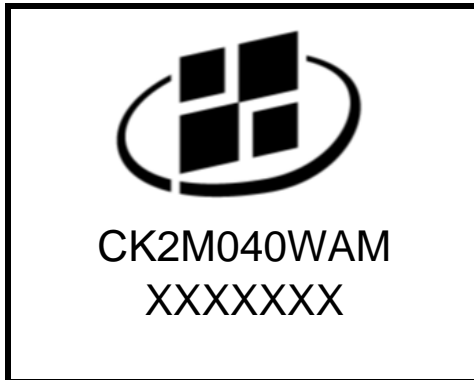

Note:

CK2M040WAM = Product Name Code

XXXXXXX = Date Code

Contact ALKAIDSEMI sales for detail information

Revision History		
Revision	Release Date	Remark
Rev.1.6	2023/12/8	

Disclaimer

The information given in this document describes the independent performance of the product, but similar performance is not guaranteed under other working conditions, and cannot be guaranteed when installed with other products or equipment. To achieve the required performance of the product in actual scenarios, the customer should conduct a complete application test to assess the functionality of the product.

Alkaidsemi assumes no responsibility for equipment failures result from using products at values that exceed the ratings, operating conditions, or other parameters listed in the product specifications.

The product described in this specification is not applicable for aerospace or other applications which requires high reliability. Customers using or selling these products for use in medical, life-saving, or life-sustaining applications do so at their own risk and agree to fully indemnify.

Due to product or technical improvements, the information described or contained herein may be changed without prior notice.