

# 1200V 80mohm Silicon Carbide Power MOSFET AKCK2M080WAMH

## Features:

- High blocking voltage with low  $R_{DS(ON)}$
- Fast switching speed with low capacitances
- Fast intrinsic diode with low reverse recovery ( $Q_{RR}$ )
- Halogen-free, RoHS compliant <sup>(Note 1)</sup>

## Applications:

- PFC
- EV battery charges
- High voltage DC/DC converters
- Booster converters
- Solar inverters

## Key Performance Parameters:

Parameter	Value	Unit
$V_{DS}$	1200	V
$R_{DS(ON), TYP} @ V_{GS} = 18 V$	80	$m\Omega$
$I_D$	35	A
$P_D$	187	W

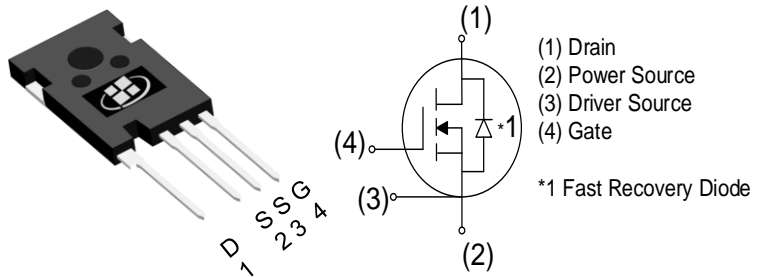

## Ordering Information:

Ordering Code	Package Type	Marking Code	Form	Packing
AKCK2M080WAMH	TO-247-4L	CK2M080WAMH	Tube	300 per box

## Notes:

1. Contact ALKAIDSEMI sales for detail information

## Maximum Ratings ( $T_A = 25^\circ\text{C}$ unless otherwise noted)

Symbol	Parameter	Value	Units
$V_{DS}$	Drain-Source Voltage	1200	V
$I_D$	Drain Current - Continuous ( $T_C = 25^\circ\text{C}$ ) <small>(Note 1)</small>	35	A
	Drain Current - Continuous ( $T_C = 100^\circ\text{C}$ ) <small>(Note 1)</small>	25	A
$I_{DM}$	Drain Current - Pulsed <small>(Note 2)</small>	80	A
$V_{GS}$	Gate-Source Voltage (dynamic)	-10/+22	V
$V_{GS}$	Gate-Source Voltage (static)	-6/+18	V
$P_D$	Power Dissipation ( $T_C = 25^\circ\text{C}$ )	187	W
$T_J, T_{STG}$	Operating and Storage Temperature Range	-55 to +175	$^\circ\text{C}$

## Thermal Characteristics

Symbol	Parameter	Value	Units
$R_{\theta JC}$	Thermal Resistance, Junction-to-Case, Steady-State	0.8	$^\circ\text{C}/\text{W}$
$R_{\theta JA}$	Thermal Resistance, Junction-to-Ambient, Steady-State	40	$^\circ\text{C}/\text{W}$

### Notes:

1. The max drain current limited by maximum junction temperature
2. Repetitive Rating: Pulse width limited by maximum junction temperature

<b>Electrical Characteristics</b> ( $T_J = 25^\circ\text{C}$ unless otherwise noted)						
Symbol	Parameter	Test Conditions	Min	Typ	Max	Units
<b>Static Characteristics</b>						
$BV_{DSS}$	Drain-Source Breakdown Voltage	$V_{GS} = 0\text{ V}, I_D = 100\ \mu\text{A}$	1200			V
$I_{DSS}$	Zero Gate Voltage Drain Current	$V_{DS} = 1200\text{ V}, V_{GS} = 0\text{ V}$		5	50	$\mu\text{A}$
$I_{GSS}$	Gate Leakage Current	$V_{GS} = +18\text{ V}, V_{DS} = 0\text{ V}$			100	nA
		$V_{GS} = -6\text{ V}, V_{DS} = 0\text{ V}$			100	nA
$V_{GS(TH)}$	Gate Threshold voltage	$V_{DS} = V_{GS}, I_D = 5\text{ mA}$	2.2	3.2	4.5	V
		$V_{DS} = V_{GS}, I_D = 5\text{ mA}, T_J = 175^\circ\text{C}$		2.2		V
$R_{DS(ON)}$	Drain-Source on-state resistance	$V_{GS} = 18\text{ V}, I_D = 20\text{ A}$		80	95	m $\Omega$
		$V_{GS} = 18\text{ V}, I_D = 20\text{ A}, T_J = 175^\circ\text{C}$		128		m $\Omega$
$G_{FS}$	Forward Transconductance	$V_{DS} = 20\text{ V}, I_D = 20\text{ A}$		11		S
		$V_{DS} = 20\text{ V}, I_D = 20\text{ A}, T_J = 175^\circ\text{C}$		9.5		S
<b>Dynamic Characteristics</b>						
$C_{ISS}$	Input Capacitance	$V_{DS} = 800\text{ V}, V_{GS} = 0\text{ V}, F = 100\text{ kHz}, V_{AC} = 25\text{ mV}$		1295		pF
$C_{OSS}$	Output Capacitance			65		pF
$C_{RSS}$	Reverse Transfer Capacitance			8		pF
$E_{OSS}$	$C_{OSS}$ Stored Energy			26		$\mu\text{J}$
$R_G$	Gate Resistance	$F = 1\text{ MHz}, V_{AC} = 25\text{ mV}$		5.4		$\Omega$
$Q_{GS}$	Gate-Source Charge	$V_{DS} = 800\text{ V}, I_D = 20\text{ A}, V_{GS} = -5/+18\text{ V}$		17		nC
$Q_{GD}$	Gate-Drain Charge			36		nC
$Q_G$	Total Gate Charge			68.6		nC

Switching Characteristics <sup>(NOTE3)</sup>							
Symbol	Parameter	Test Conditions	Min	Typ	Max	Units	
$T_{D(ON)}$	Turn On Delay Time	$V_{DD} = 800\text{ V}$ , $I_D = 20\text{ A}$ , $V_{GS} = -5/+18\text{ V}$ , $R_{G,EXT} = 5\ \Omega$ $L = 99\ \mu\text{H}$  Diode: Body Diode at $V_{GS} = -5\text{V}$		14		nS	
$T_R$	Rise Time			10		nS	
$T_{D(OFF)}$	Turn Off Delay Time				21		nS
$T_F$	Fall Time				17		nS
$E_{ON}$	Turn On Energy				625		$\mu\text{J}$
$E_{OFF}$	Turn Off Energy				57		$\mu\text{J}$
$T_{D(ON)}$	Turn On Delay Time	$V_{DD} = 800\text{ V}$ , $I_D = 20\text{ A}$ , $V_{GS} = -5/+18\text{ V}$ , $R_{G,EXT} = 5\ \Omega$ $L = 99\ \mu\text{H}$  Diode: Body Diode at $V_{GS} = -5\text{V}$ $T_J = 175\text{ }^\circ\text{C}$		13		nS	
$T_R$	Rise Time				8		nS
$T_{D(OFF)}$	Turn Off Delay Time				23		nS
$T_F$	Fall Time				15		nS
$E_{ON}$	Turn On Energy				579		$\mu\text{J}$
$E_{OFF}$	Turn Off Energy				54		$\mu\text{J}$

Note3: All switching characteristics reference TO247-3L.

### Drain-Source Diode Characteristics ( $T_J = 25\text{ }^\circ\text{C}$ unless otherwise noted)

$I_S$	Maximum Continuous Drain-Source Diode Forward Current			35		A
$I_{SM}$	Maximum Pulsed Drain-Source Diode Forward Current			80		A
$V_{SD}$	Diode Forward Voltage	$V_{GS} = -4\text{ V}$ , $I_{SD} = 20\text{ A}$		5		V
		$V_{GS} = -4\text{ V}$ , $I_{SD} = 20\text{ A}$ , $T_J = 175\text{ }^\circ\text{C}$		3.4		V
$I_{RM}$	Peak Reverse Recovery Current	$V_{GS} = -4\text{ V}$ , $I_{SD} = 20\text{ A}$ , $V_R = 800\text{ V}$ , $di/dt = 460\text{ A}/\mu\text{S}$		5		A
$T_{RR}$	Reverse Recovery Time			17		nS
$Q_{RR}$	Reverse Recovery Charge				44	

# Electrical Characteristics Diagrams (Note4)

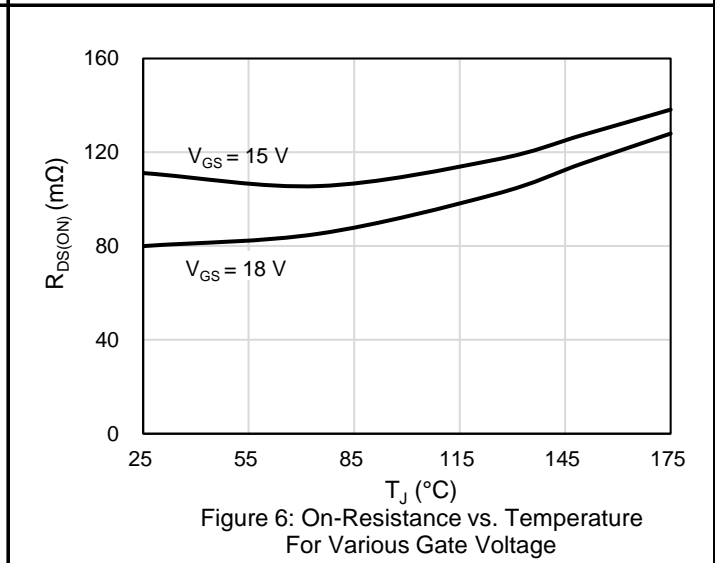
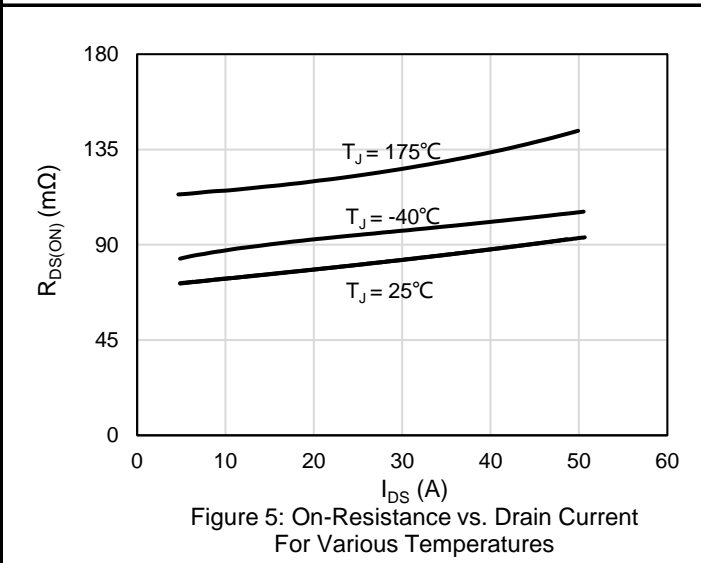
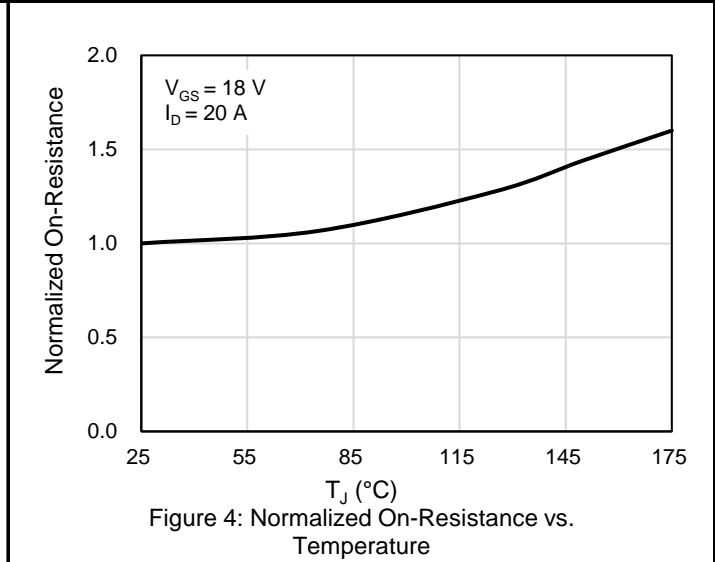
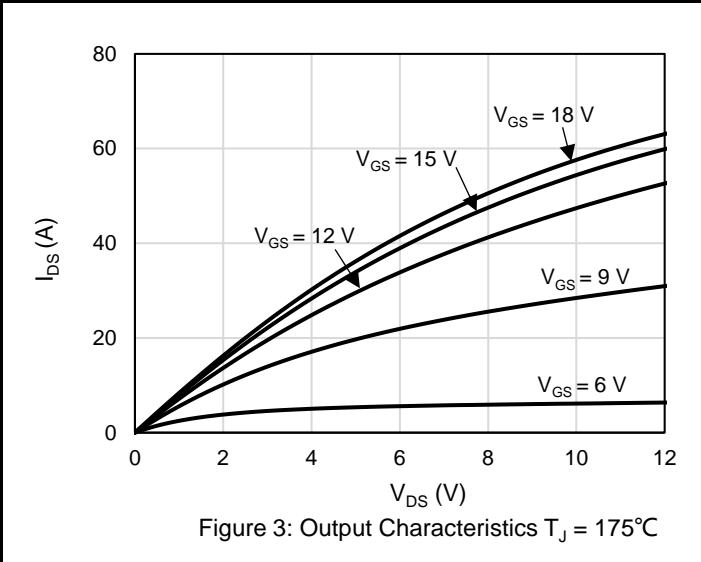
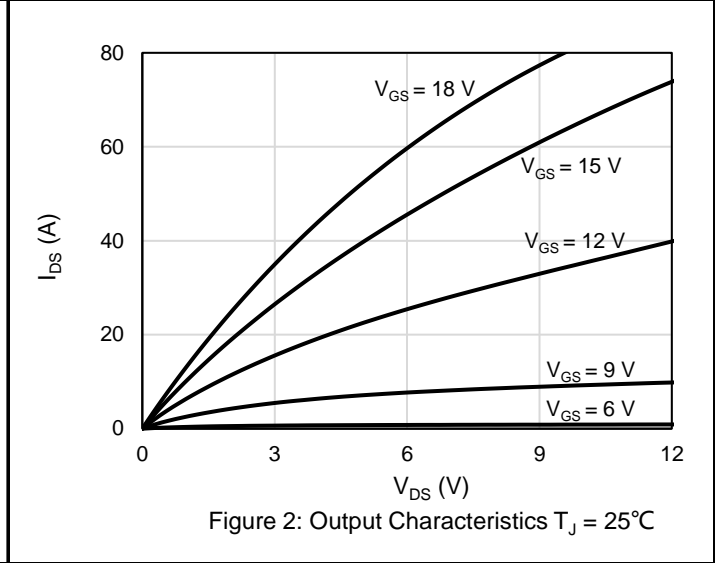
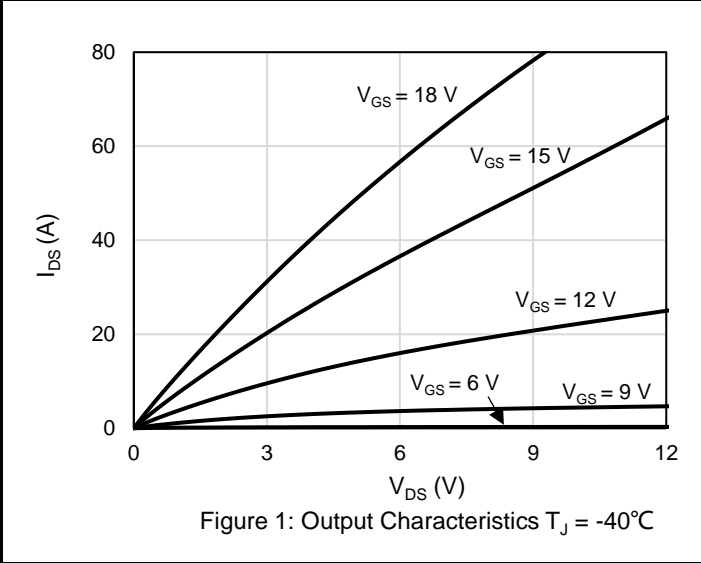

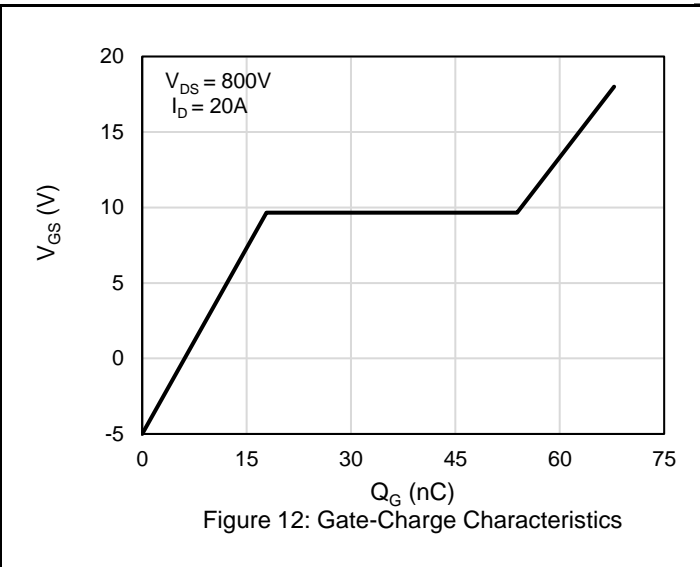
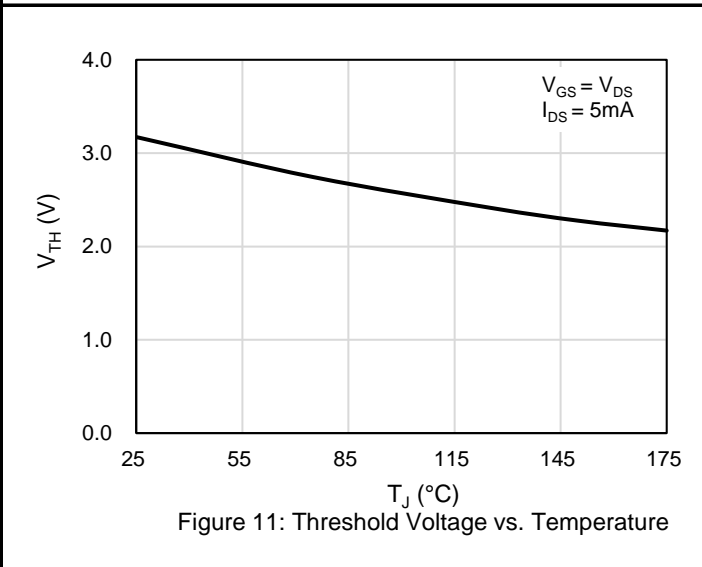
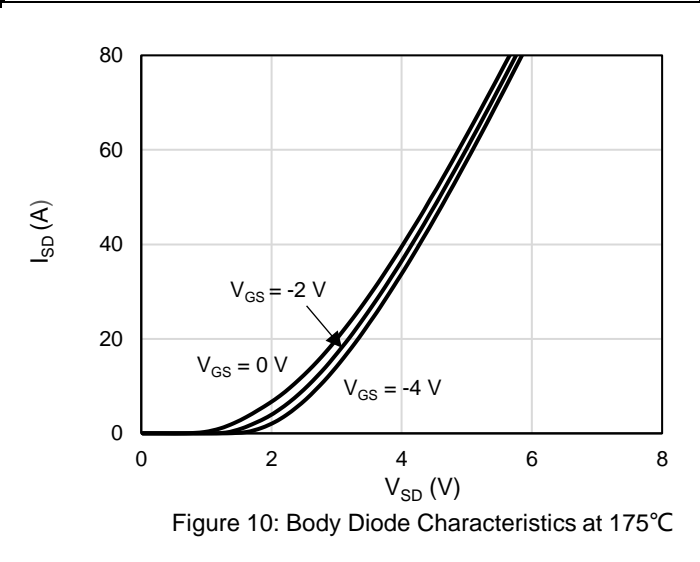
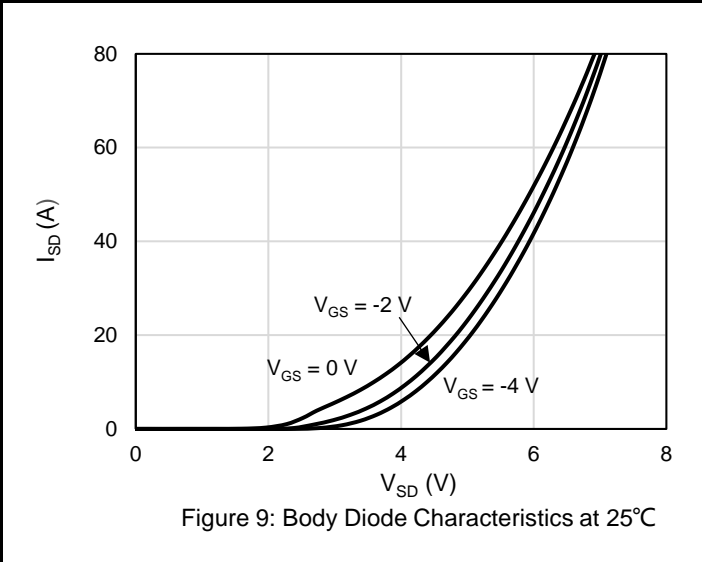
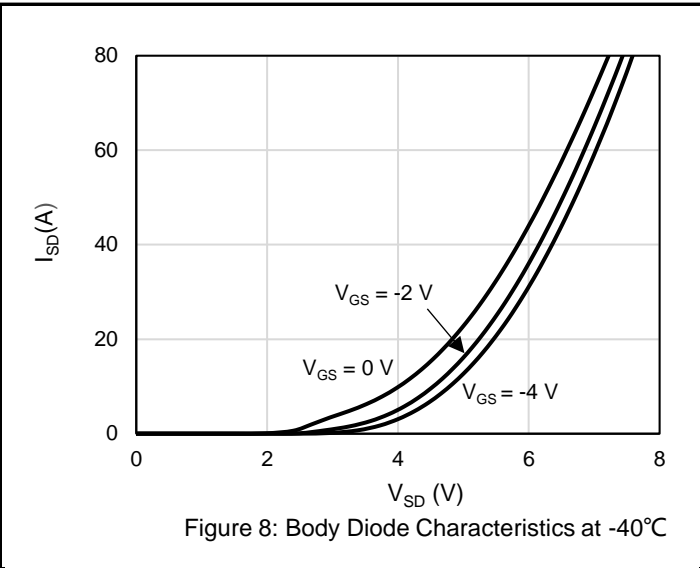
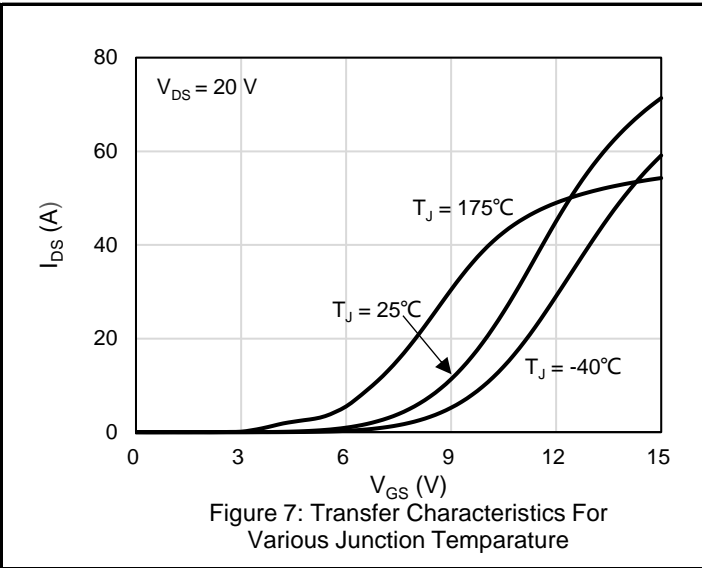

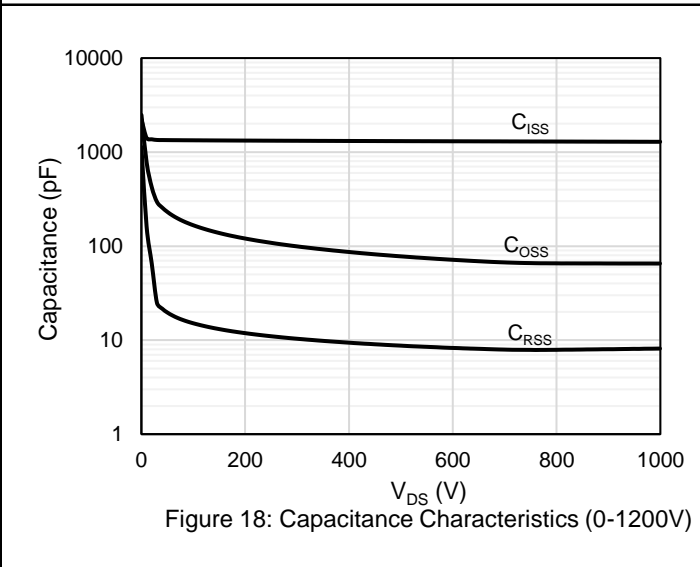
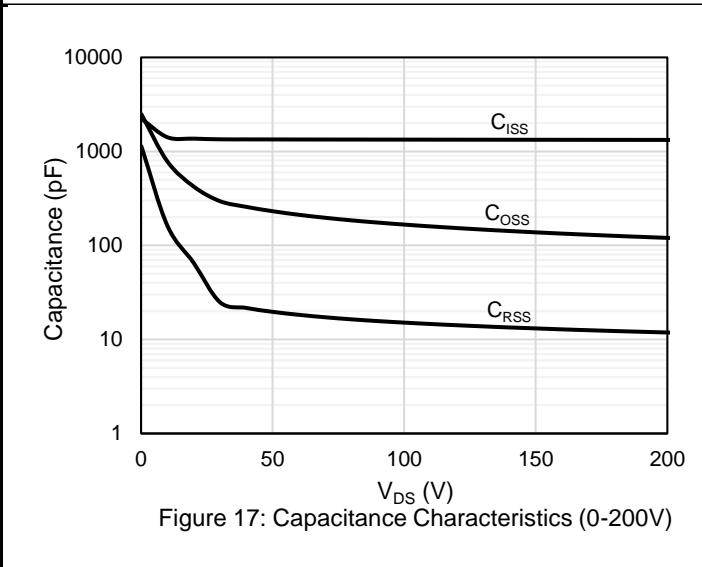
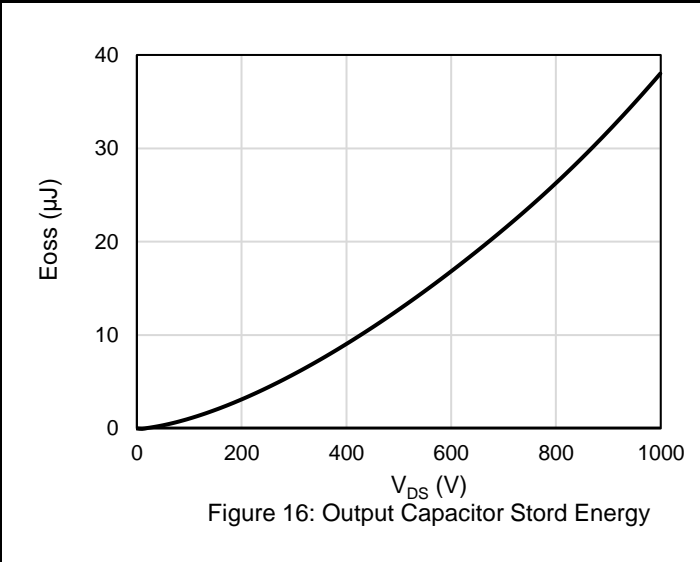
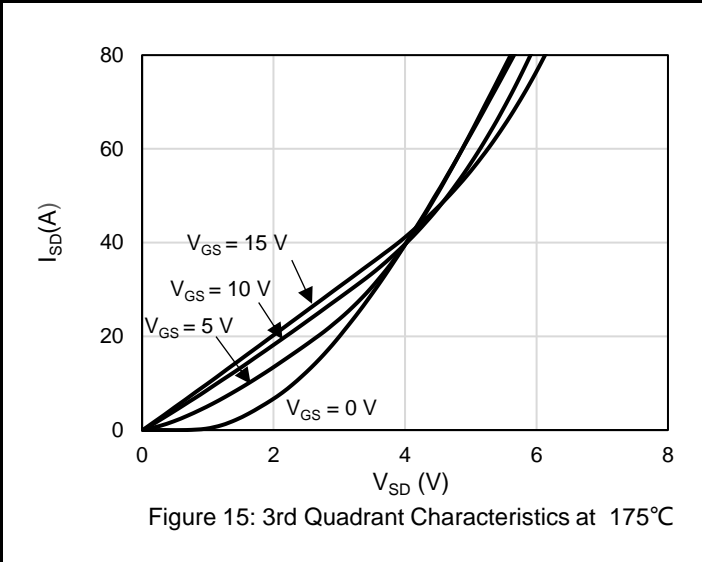
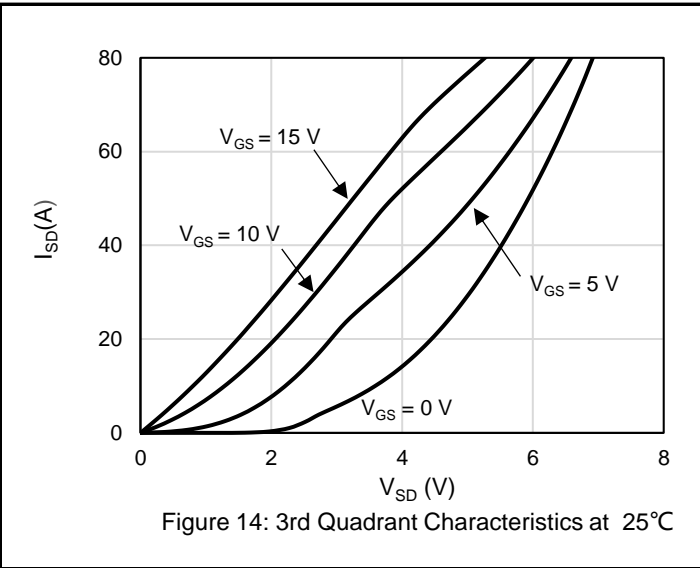
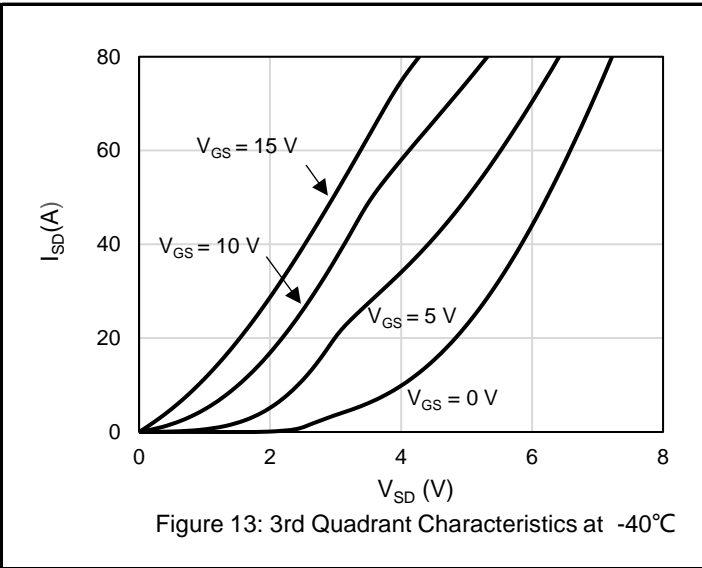

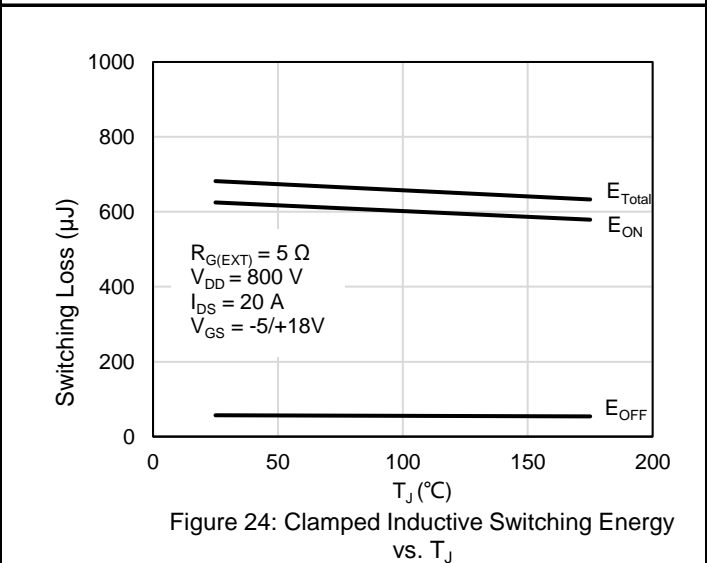
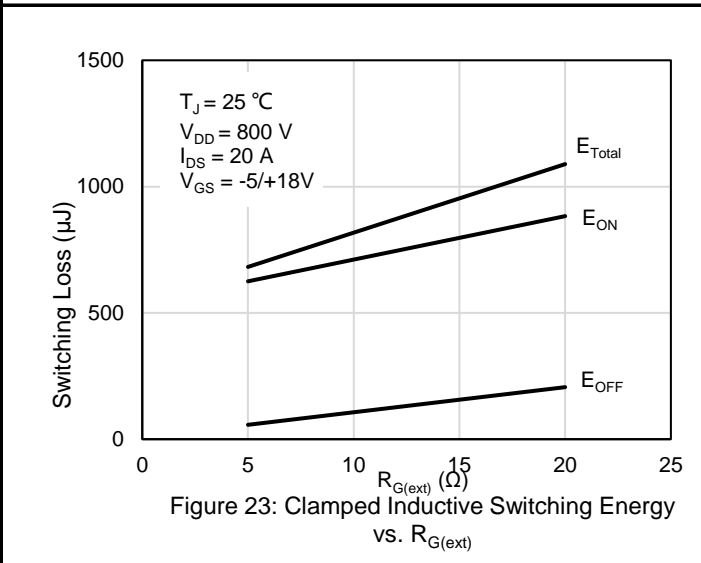
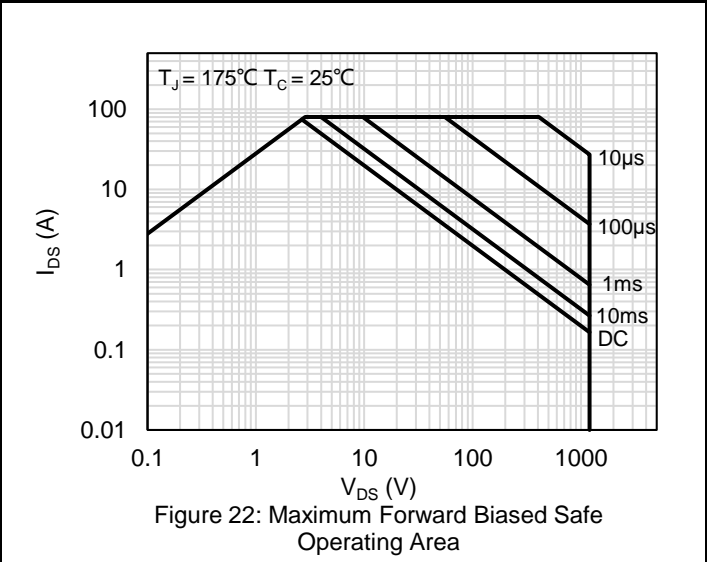
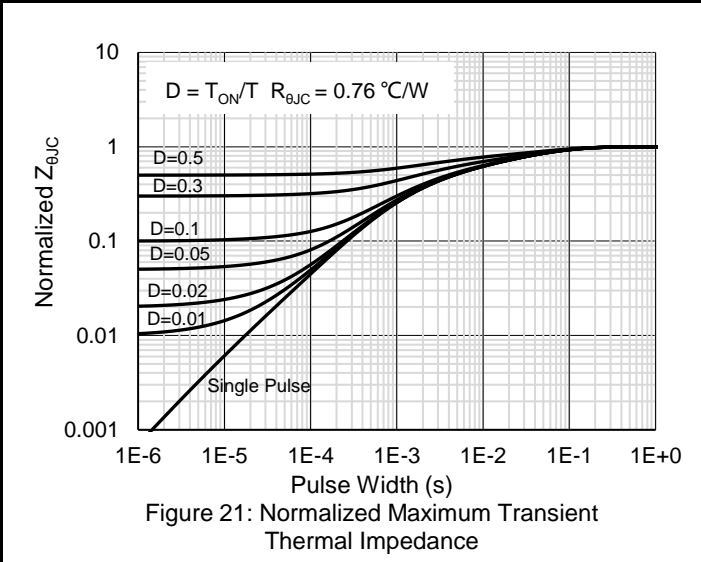
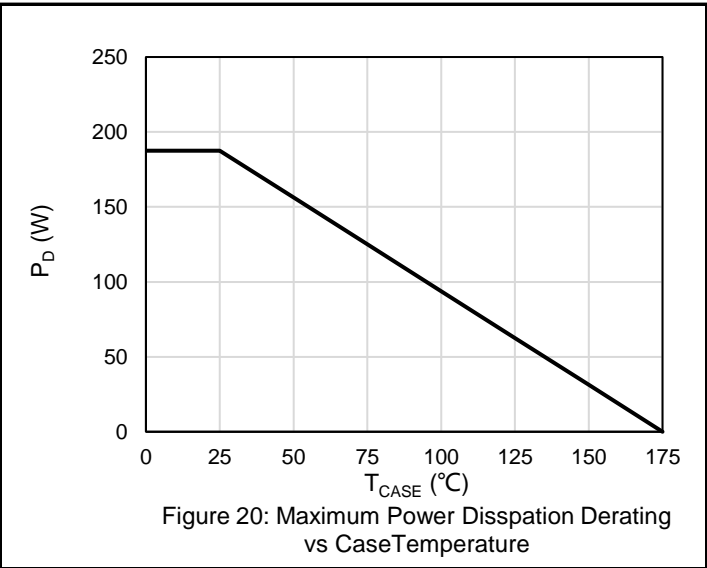
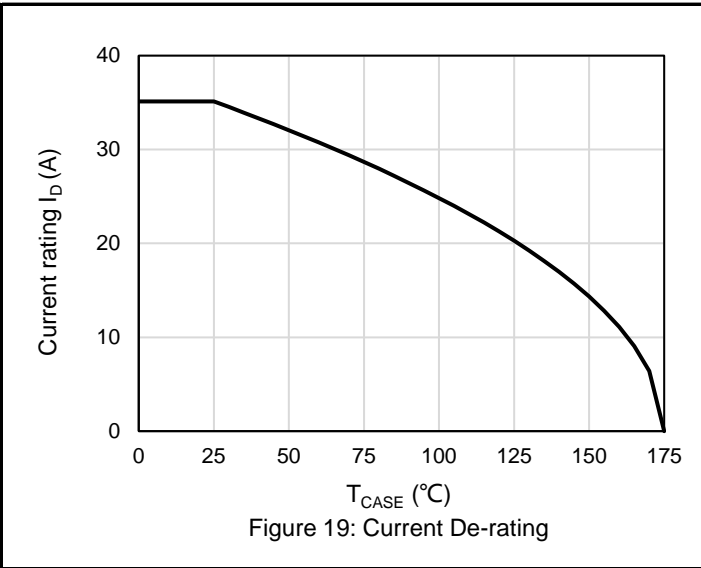



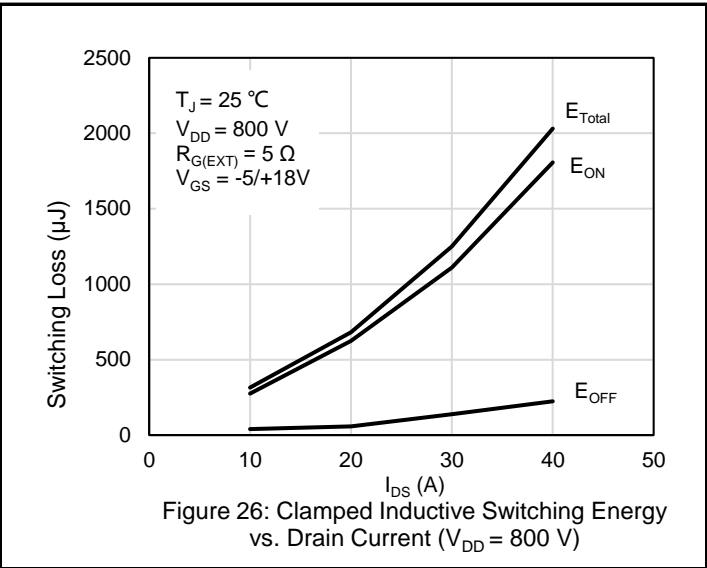
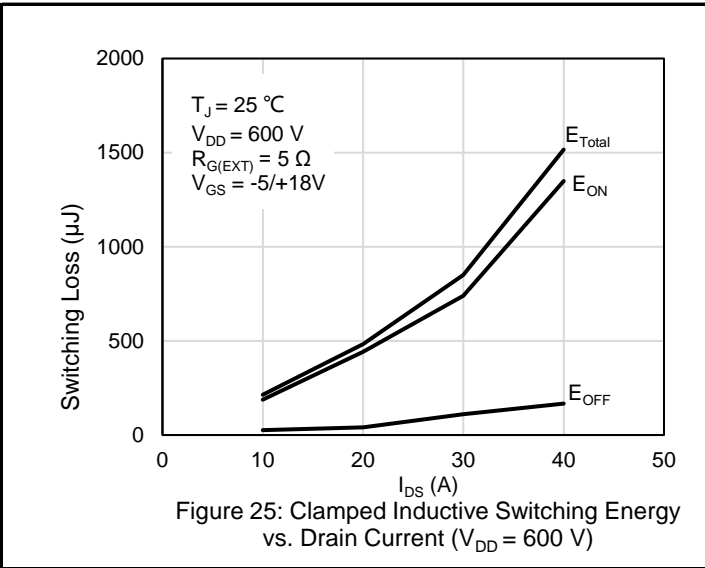

Note4: All figures reference T0247-3L.

# Test Circuit and Waveform

Gate Charge Test Circuit & Waveform

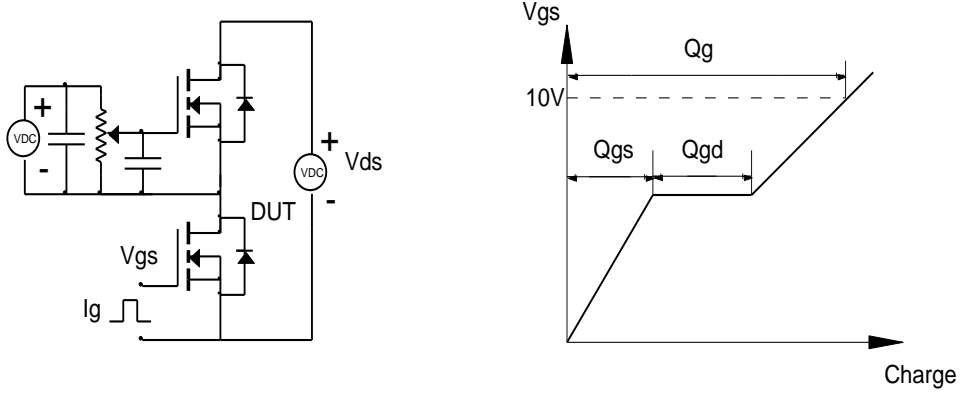

Clamped Inductive Switching Test Circuit & Waveforms

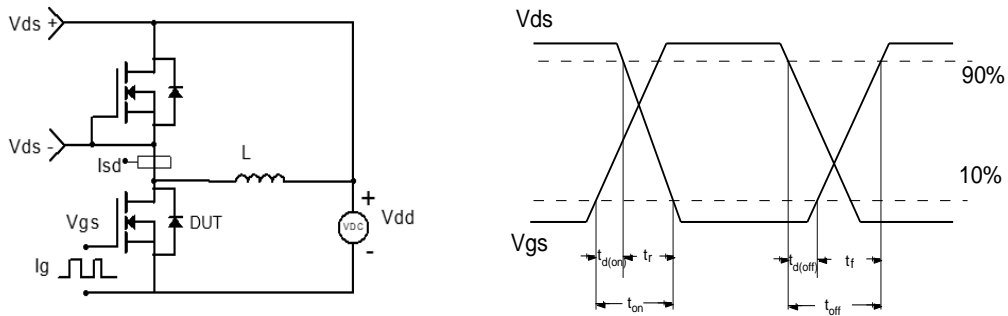

Diode Recovery Test Circuit & Waveforms

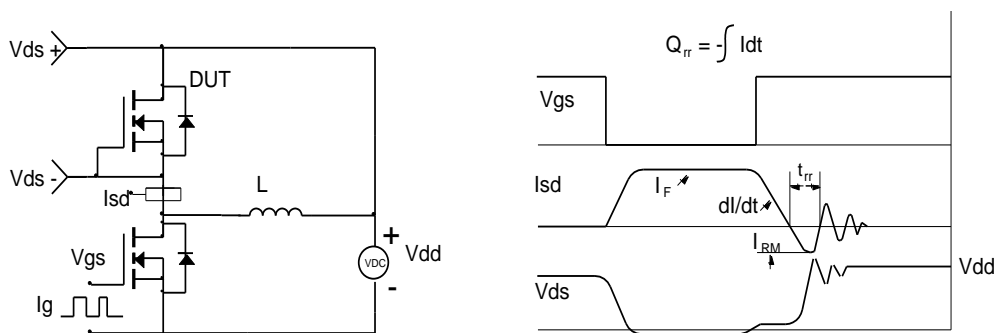

# Package Outlines

## TO-247-4L PKG Outlines

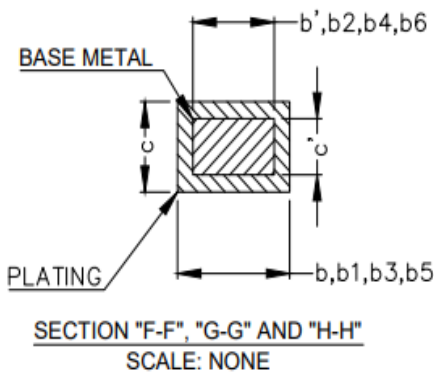
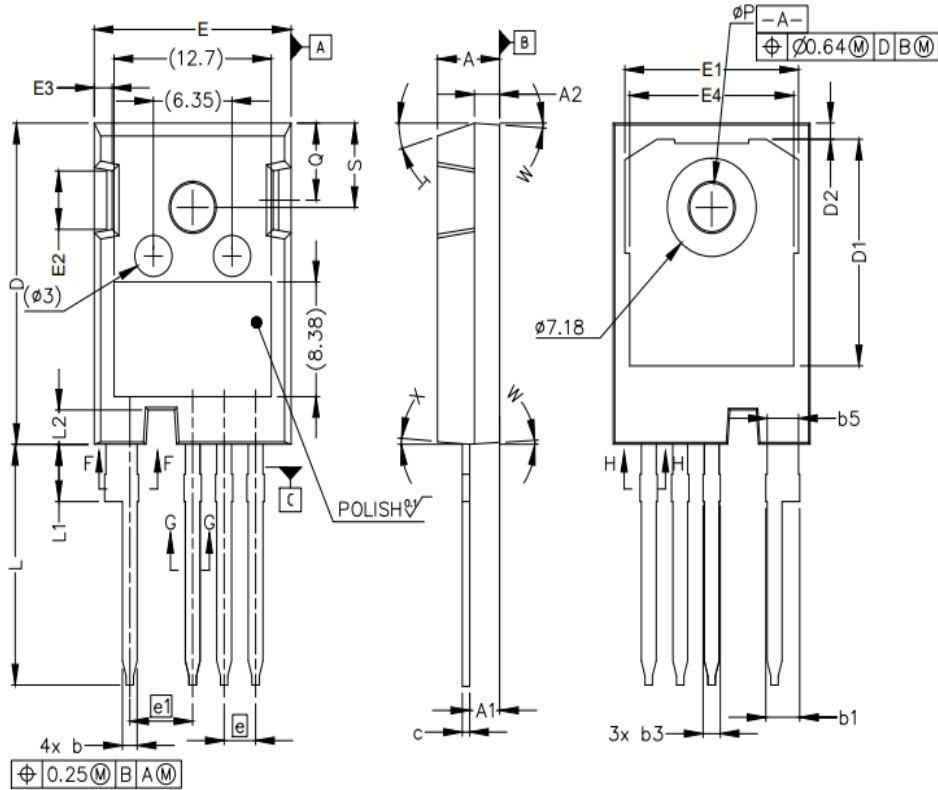

SYMBOL	MILLIMETERS	
	MIN	MAX
A	4.83	5.21
A1	2.29	2.54
A2	1.91	2.16
b'	1.07	1.28
b	1.07	1.33
b1	2.39	2.94
b2	2.39	2.84
b3	1.07	1.60
b4	1.07	1.50
b5	2.39	2.69
b6	2.39	2.64
c'	0.55	0.65
c	0.55	0.68
D	23.30	23.60
D1	16.25	17.65
D2	0.95	1.25
E	15.75	16.13
E1	13.10	14.15
E2	3.68	5.10
E3	1.00	1.90
E4	12.38	13.43
e	2.54 BSC	
e1	5.08 BSC	
N	4	
L	17.31	17.82
L1	3.97	4.37
L2	2.35	2.65
øP	3.51	3.65
Q	5.49	6.00
S	6.04	6.30
T	17.5° REF.	
W	3.5° REF.	
X	4° REF.	

## Marking Information



Note:

CK2M080WAMH = Product Name Code

XXXXXXX = Date Code

Contact ALKAIDSEMI sales for detail information

Revision History		
Revision	Release Date	Remark
Rev.1.7	2023/7/13	

## Disclaimer

The information given in this document describes the independent performance of the product, but similar performance is not guaranteed under other working conditions, and cannot be guaranteed when installed with other products or equipment. To achieve the required performance of the product in actual scenarios, the customer should conduct a complete application test to assess the functionality of the product.

Alkaidsemi assumes no responsibility for equipment failures result from using products at values that exceed the ratings, operating conditions, or other parameters listed in the product specifications.

The product described in this specification is not applicable for aerospace or other applications which requires high reliability. Customers using or selling these products for use in medical, life-saving, or life-sustaining applications do so at their own risk and agree to fully indemnify.

Due to product or technical improvements, the information described or contained herein may be changed without prior notice.