

1200V 80mohm Silicon Carbide Power MOSFET AKCK2M080WMH

Features:

- High blocking voltage with low $R_{DS(ON)}$
- Fast switching speed with low capacitances
- Fast intrinsic diode with low reverse recovery (Q_{RR})
- Halogen-free, RoHS compliant ^(Note 1)

Applications:

- PFC
- EV battery charges
- High voltage DC/DC converters
- Booster converters
- Solar inverters

Key Performance Parameters:

Parameter	Value	Unit
V_{DS}	1200	V
$R_{DS(ON), TYP} @ V_{GS} = 18 V$	80	m Ω
I_D	35	A
P_D	187	W

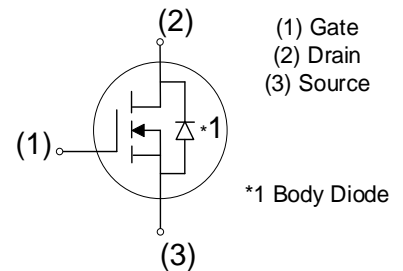
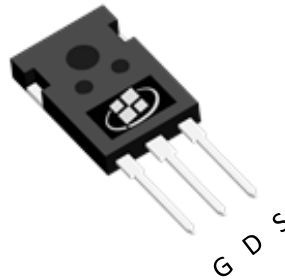

Ordering Information:

Ordering Code	Package Type	Marking Code	Form	Packing
AKCK2M080WMH	TO-247-3L	CK2M080WMH	Tube	300 per box

Notes:

1. Contact ALKAIDSEMI sales for detail information

Maximum Ratings ($T_A = 25^\circ\text{C}$ unless otherwise noted)

Symbol	Parameter	Value	Units
V_{DS}	Drain-Source Voltage	1200	V
I_D	Drain Current - Continuous ($T_C = 25^\circ\text{C}$) <small>(Note 1)</small>	35	A
	Drain Current - Continuous ($T_C = 100^\circ\text{C}$) <small>(Note 1)</small>	25	A
I_{DM}	Drain Current - Pulsed <small>(Note 2)</small>	80	A
V_{GS}	Gate-Source Voltage (dynamic)	-10/+22	V
V_{GS}	Gate-Source Voltage (static)	-6/+18	V
P_D	Power Dissipation ($T_C = 25^\circ\text{C}$)	187	W
T_J, T_{STG}	Operating and Storage Temperature Range	-55 to +175	$^\circ\text{C}$

Thermal Characteristics

Symbol	Parameter	Value	Units
$R_{\theta JC}$	Thermal Resistance, Junction-to-Case, Steady-State	0.8	$^\circ\text{C}/\text{W}$
$R_{\theta JA}$	Thermal Resistance, Junction-to-Ambient, Steady-State	40	$^\circ\text{C}/\text{W}$

Notes:

1. The max drain current limited by maximum junction temperature
2. Repetitive Rating: Pulse width limited by maximum junction temperature

Electrical Characteristics ($T_J = 25^\circ\text{C}$ unless otherwise noted)

Symbol	Parameter	Test Conditions	Min	Typ	Max	Units
Static Characteristics						
BV_{DSS}	Drain-Source Breakdown Voltage	$V_{GS} = 0\text{ V}, I_D = 100\ \mu\text{A}$	1200			V
I_{DSS}	Zero Gate Voltage Drain Current	$V_{DS} = 1200\text{ V}, V_{GS} = 0\text{ V}$		5	50	μA
I_{GSS}	Gate Leakage Current	$V_{GS} = +18\text{ V}, V_{DS} = 0\text{ V}$			100	nA
		$V_{GS} = -6\text{ V}, V_{DS} = 0\text{ V}$			100	nA
$V_{GS(TH)}$	Gate Threshold voltage	$V_{DS} = V_{GS}, I_D = 5\text{ mA}$	2.2	3.2	4.5	V
		$V_{DS} = V_{GS}, I_D = 5\text{ mA}, T_J = 175^\circ\text{C}$		2.2		V
$R_{DS(ON)}$	Drain-Source on-state resistance	$V_{GS} = 18\text{ V}, I_D = 20\text{ A}$		80	95	m Ω
		$V_{GS} = 18\text{ V}, I_D = 20\text{ A}, T_J = 175^\circ\text{C}$		128		m Ω
G_{FS}	Forward Transconductance	$V_{DS} = 20\text{ V}, I_D = 20\text{ A}$		11		S
		$V_{DS} = 20\text{ V}, I_D = 20\text{ A}, T_J = 175^\circ\text{C}$		9.5		S

Dynamic Characteristics

C_{ISS}	Input Capacitance	$V_{DS} = 800\text{ V}, V_{GS} = 0\text{ V}, F = 100\text{ kHz}, V_{AC} = 25\text{ mV}$		1295		pF
C_{OSS}	Output Capacitance			65		pF
C_{RSS}	Reverse Transfer Capacitance			8		pF
E_{OSS}	C_{OSS} Stored Energy			26		μJ
R_G	Gate Resistance	$F = 1\text{ MHz}, V_{AC} = 25\text{ mV}$		5.4		Ω
Q_{GS}	Gate-Source Charge	$V_{DS} = 800\text{ V}, I_D = 20\text{ A}, V_{GS} = -5/+18\text{ V}$		17		nC
Q_{GD}	Gate-Drain Charge			36		nC
Q_G	Total Gate Charge			68.6		nC

Switching Characteristics

Symbol	Parameter	Test Conditions	Min	Typ	Max	Units	
$T_{D(ON)}$	Turn On Delay Time	$V_{DD} = 800\text{ V}$, $I_D = 20\text{ A}$, $V_{GS} = -5/+18\text{ V}$, $R_{G,EXT} = 5\ \Omega$ $L = 99\ \mu\text{H}$ Diode: Body Diode at $V_{GS} = -5\text{V}$		14		nS	
T_R	Rise Time			10		nS	
$T_{D(OFF)}$	Turn Off Delay Time			21		nS	
T_F	Fall Time			17		nS	
E_{ON}	Turn On Energy				625		μJ
E_{OFF}	Turn Off Energy				57		μJ
$T_{D(ON)}$	Turn On Delay Time	$V_{DD} = 800\text{ V}$, $I_D = 20\text{ A}$, $V_{GS} = -5/+18\text{ V}$, $R_{G,EXT} = 5\ \Omega$ $L = 99\ \mu\text{H}$ Diode: Body Diode at $V_{GS} = -5\text{V}$ $T_J = 175\ \text{C}$		13		nS	
T_R	Rise Time			8		nS	
$T_{D(OFF)}$	Turn Off Delay Time			23		nS	
T_F	Fall Time			15		nS	
E_{ON}	Turn On Energy				579		μJ
E_{OFF}	Turn Off Energy				54		μJ

Drain-Source Diode Characteristics ($T_J = 25\ \text{C}$ unless otherwise noted)

I_S	Maximum Continuous Drain-Source Diode Forward Current			35		A
I_{SM}	Maximum Pulsed Drain-Source Diode Forward Current			80		A
V_{SD}	Diode Forward Voltage	$V_{GS} = -4\text{ V}$, $I_{SD} = 20\text{ A}$		5		V
		$V_{GS} = -4\text{ V}$, $I_{SD} = 20\text{ A}$, $T_J = 175\ \text{C}$		3.4		V
I_{RM}	Peak Reverse Recovery Current	$V_{GS} = -4\text{ V}$, $I_{SD} = 20\text{ A}$, $V_R = 800\text{ V}$, $di/dt = 460\text{ A}/\mu\text{S}$		5		A
T_{RR}	Reverse Recovery Time			17		nS
Q_{RR}	Reverse Recovery Charge				44	

Electrical Characteristics Diagrams

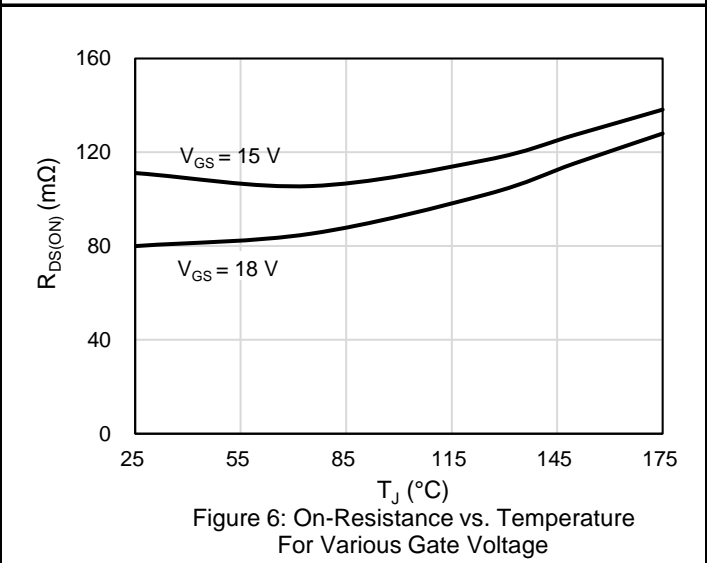
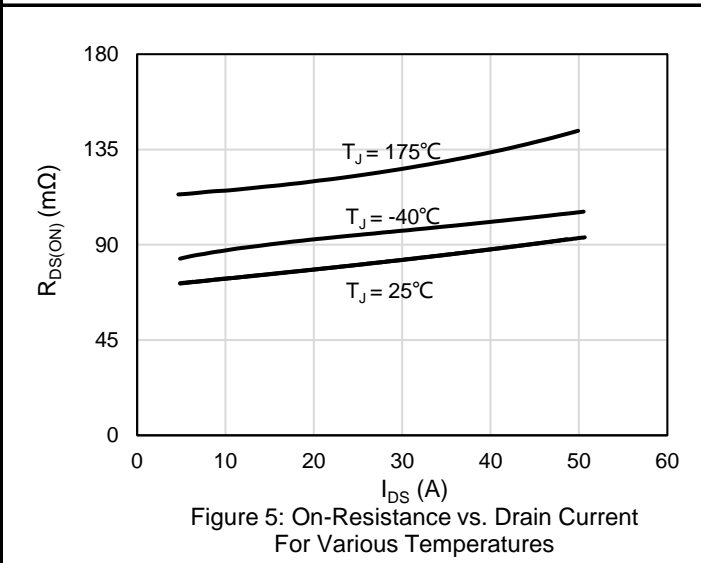
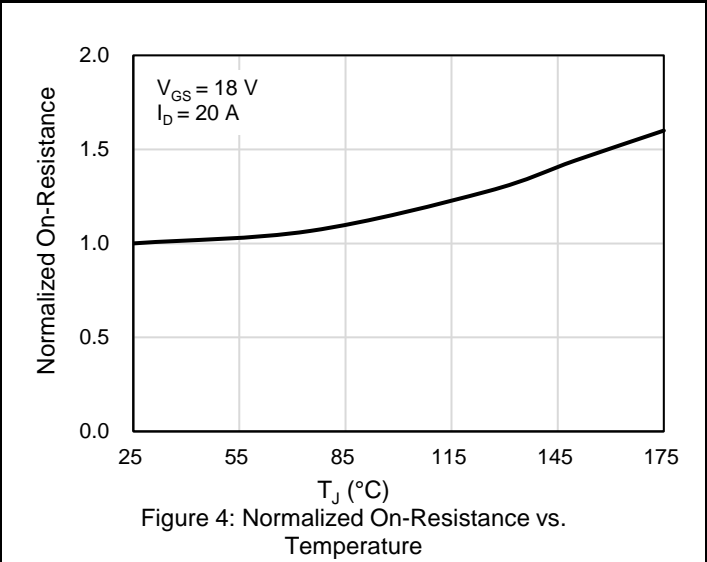
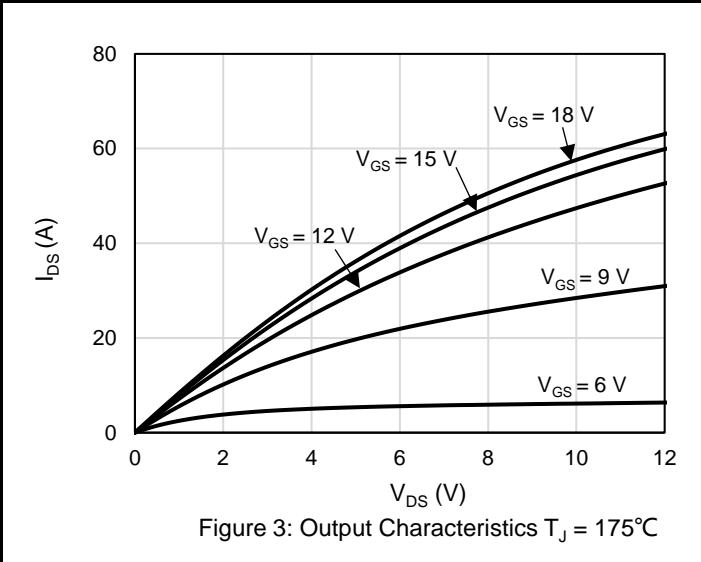
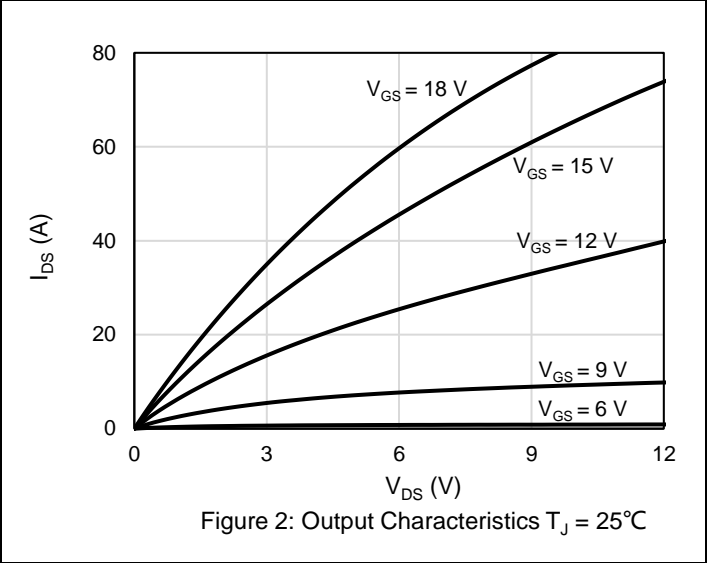
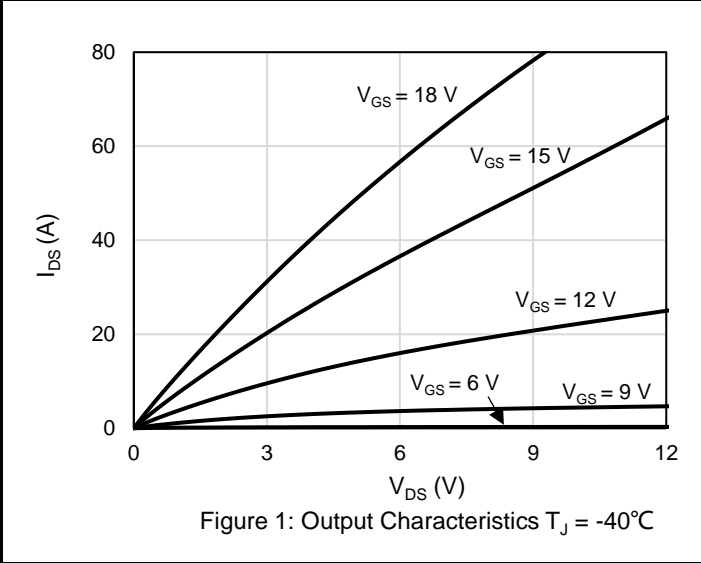

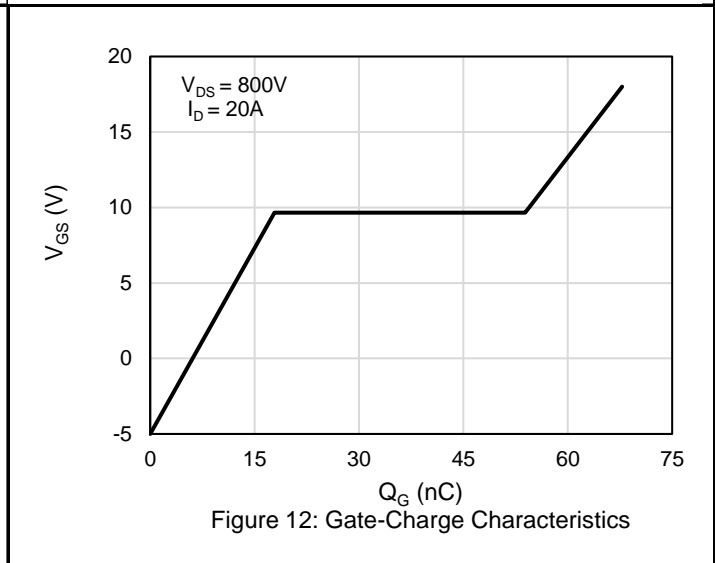
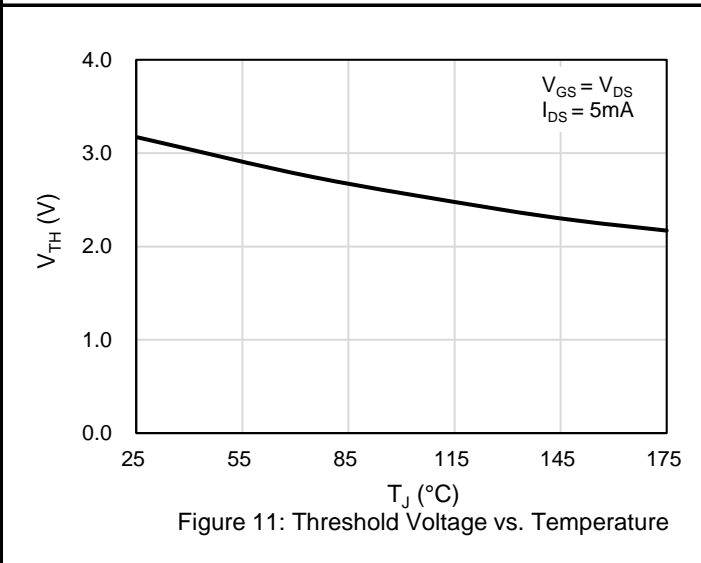
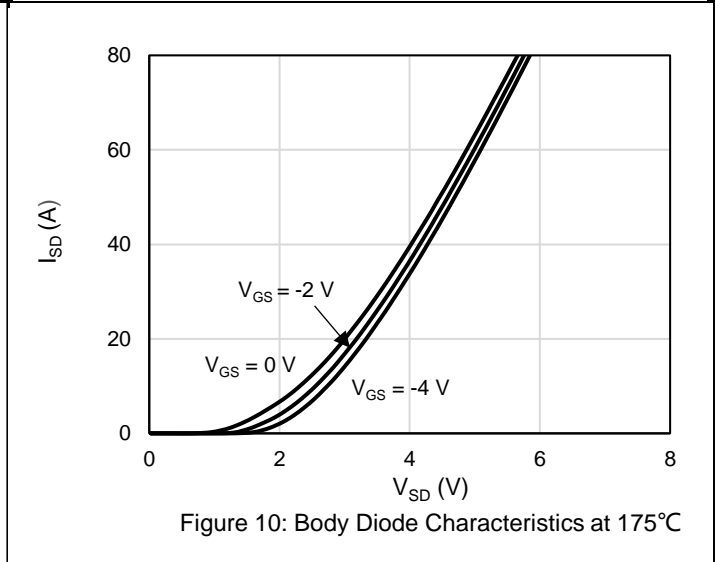
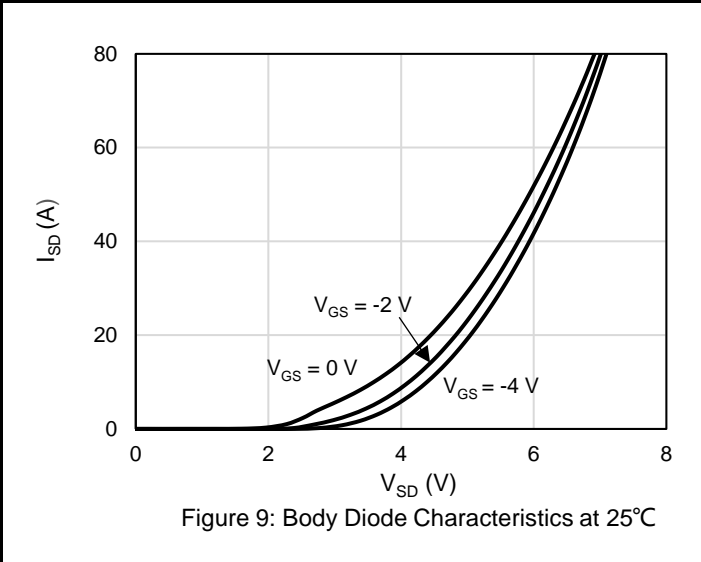
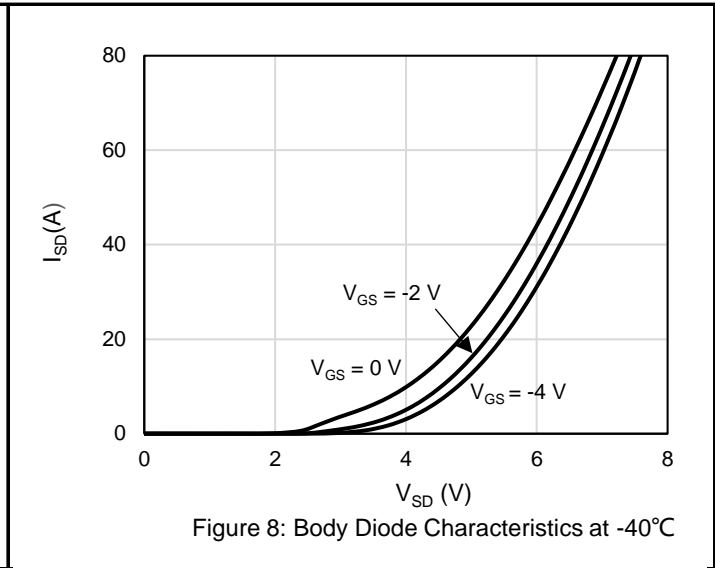
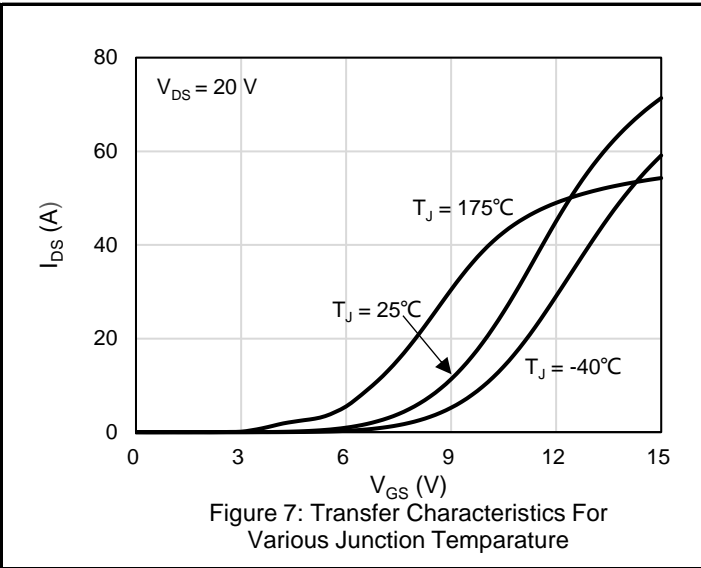

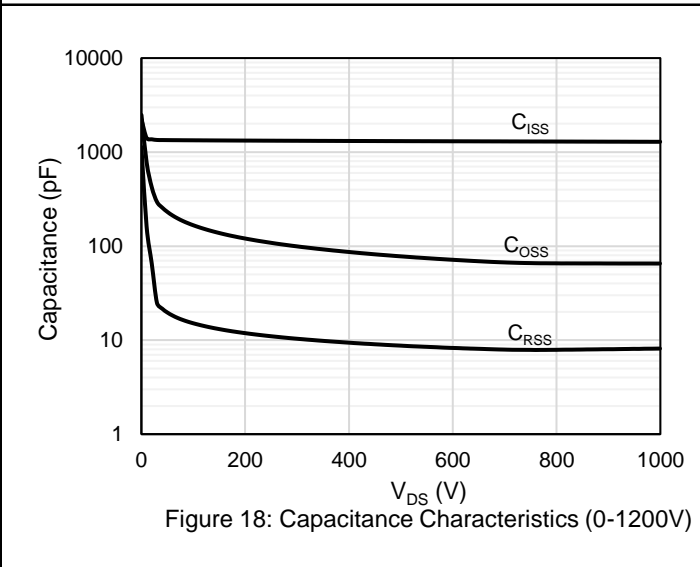
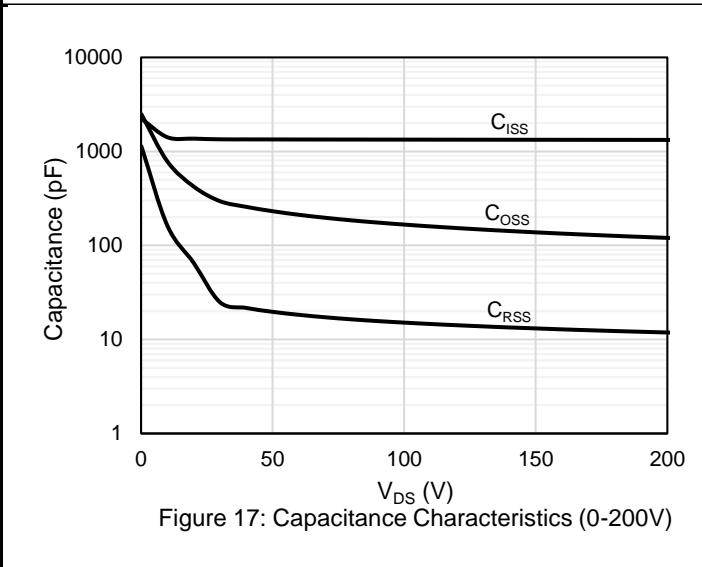
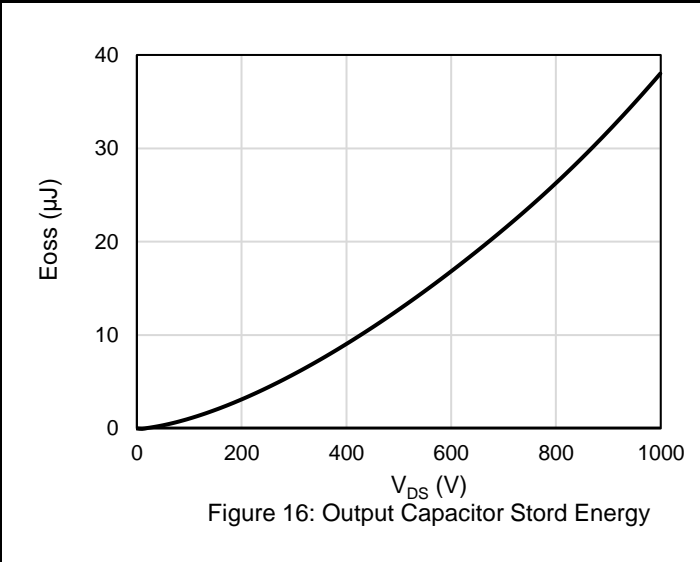
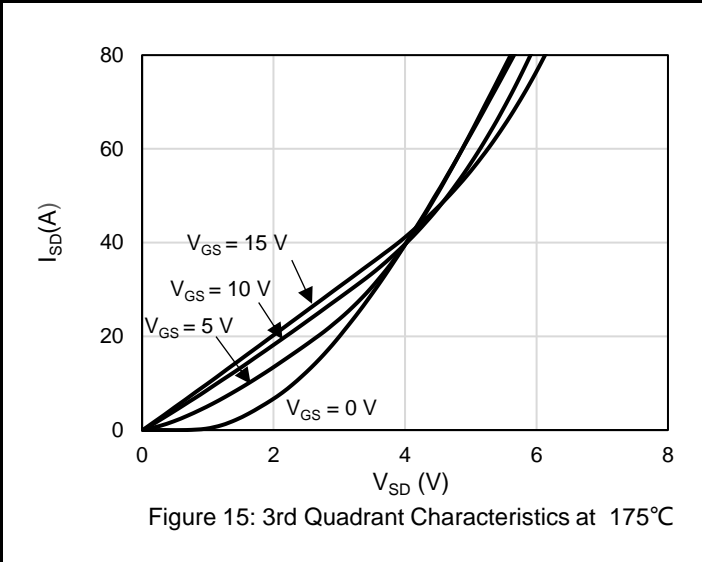
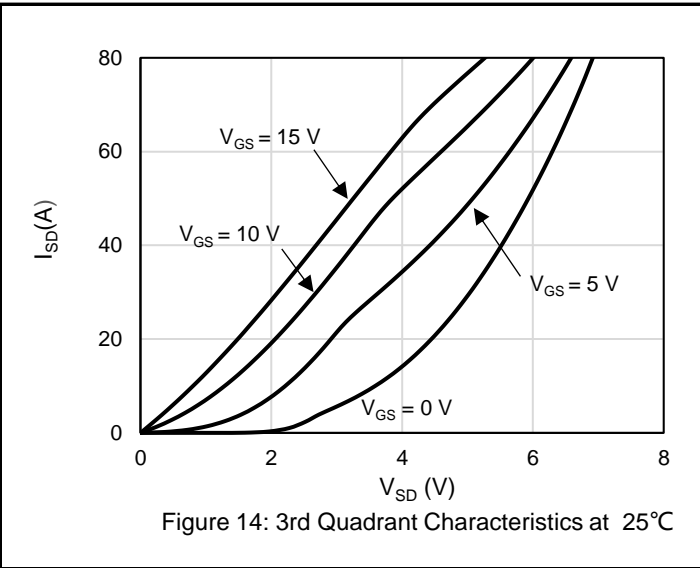
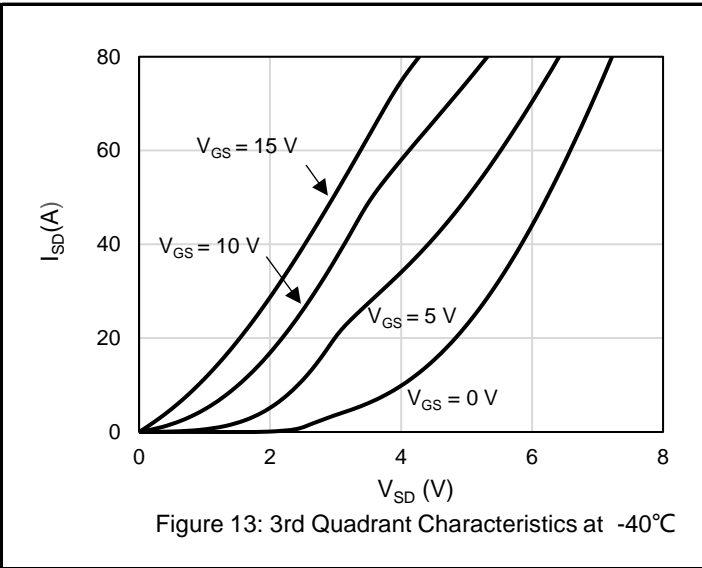

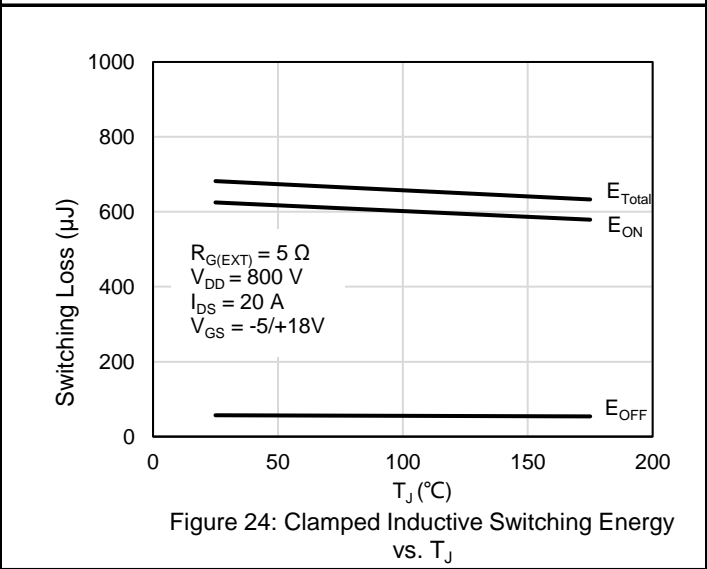
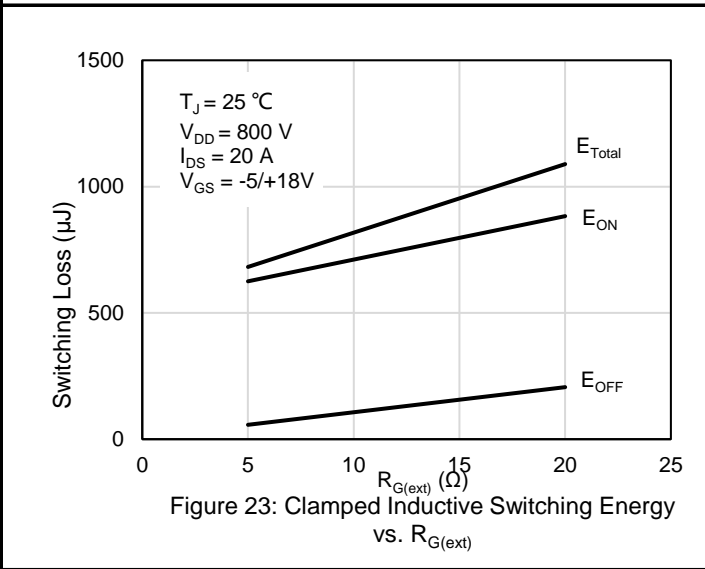
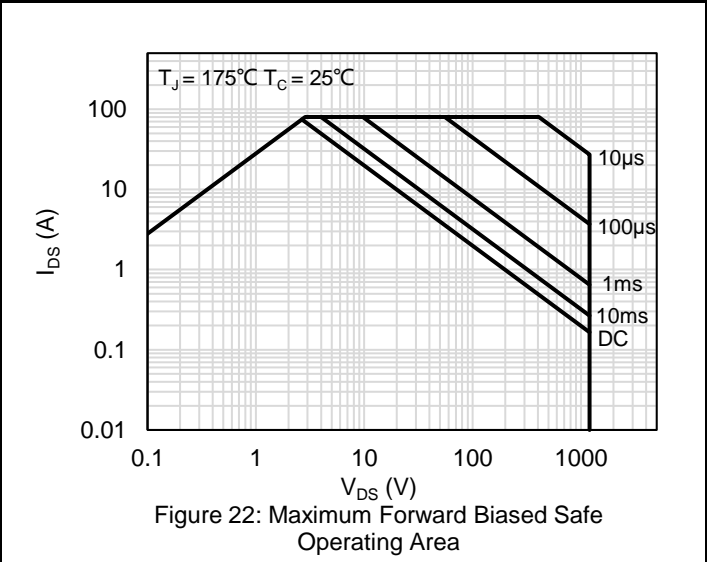
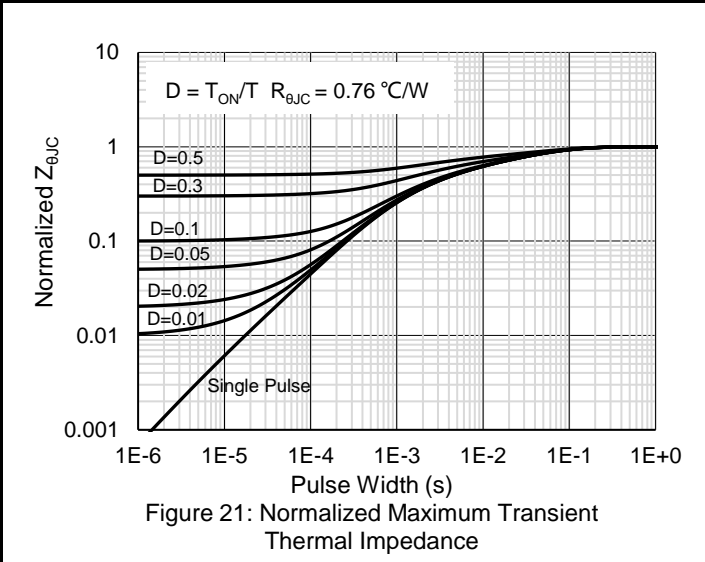
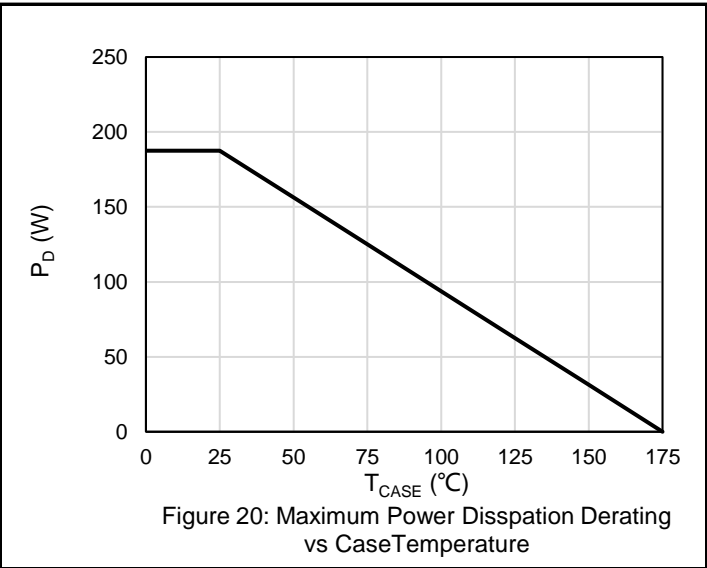
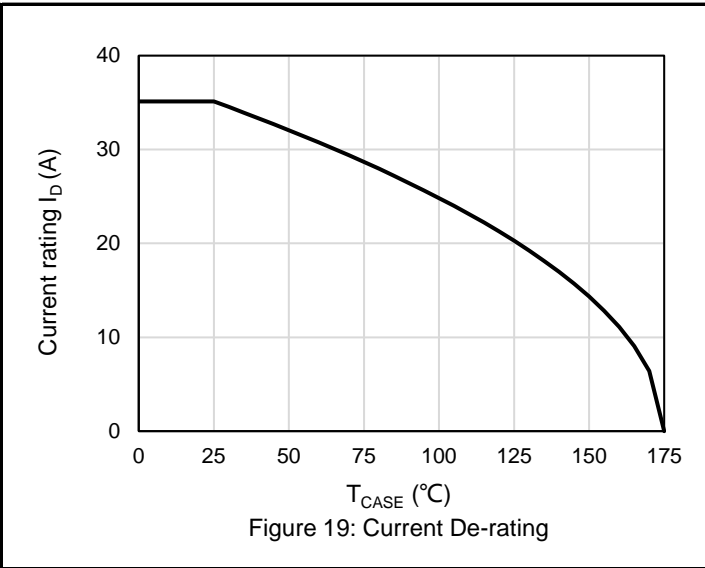

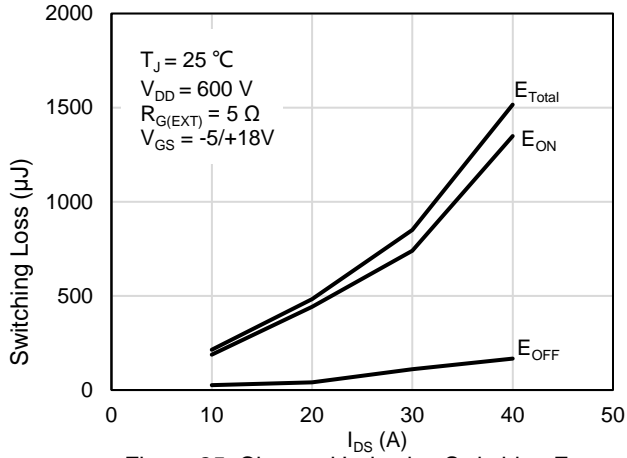

Figure 25: Clamped Inductive Switching Energy vs. Drain Current ($V_{DD} = 600\text{ V}$)

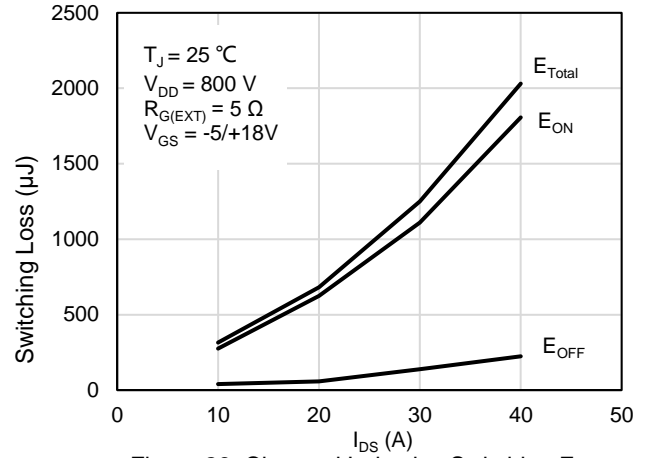
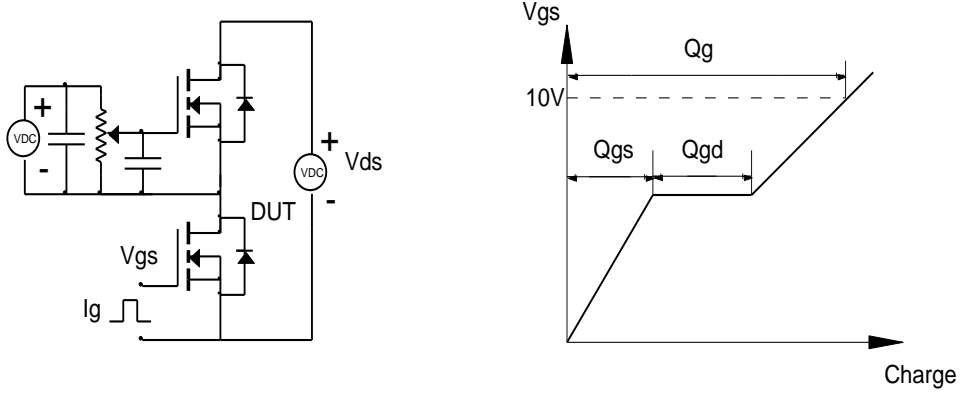

Figure 26: Clamped Inductive Switching Energy vs. Drain Current ($V_{DD} = 800\text{ V}$)

Test Circuit and Waveform

Gate Charge Test Circuit & Waveform



Clamped Inductive Switching Test Circuit & Waveforms

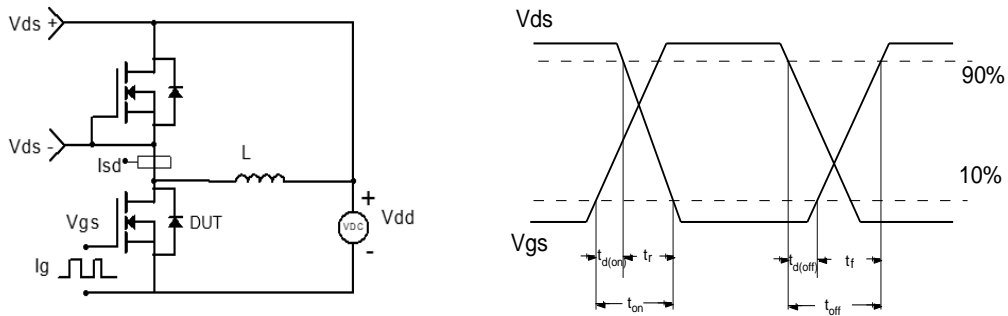

Diode Recovery Test Circuit & Waveforms

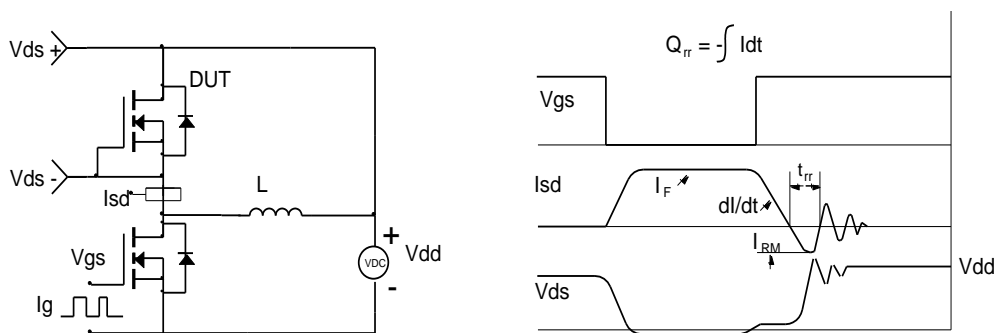

Package Outlines

TO-247-3L PKG Outlines

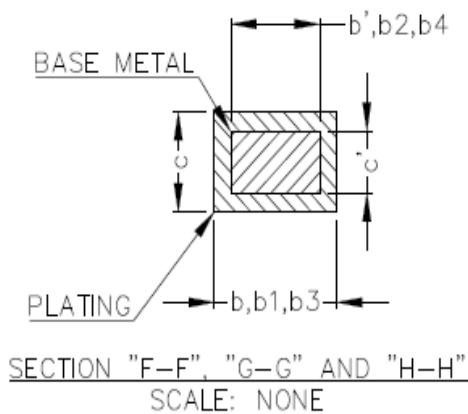
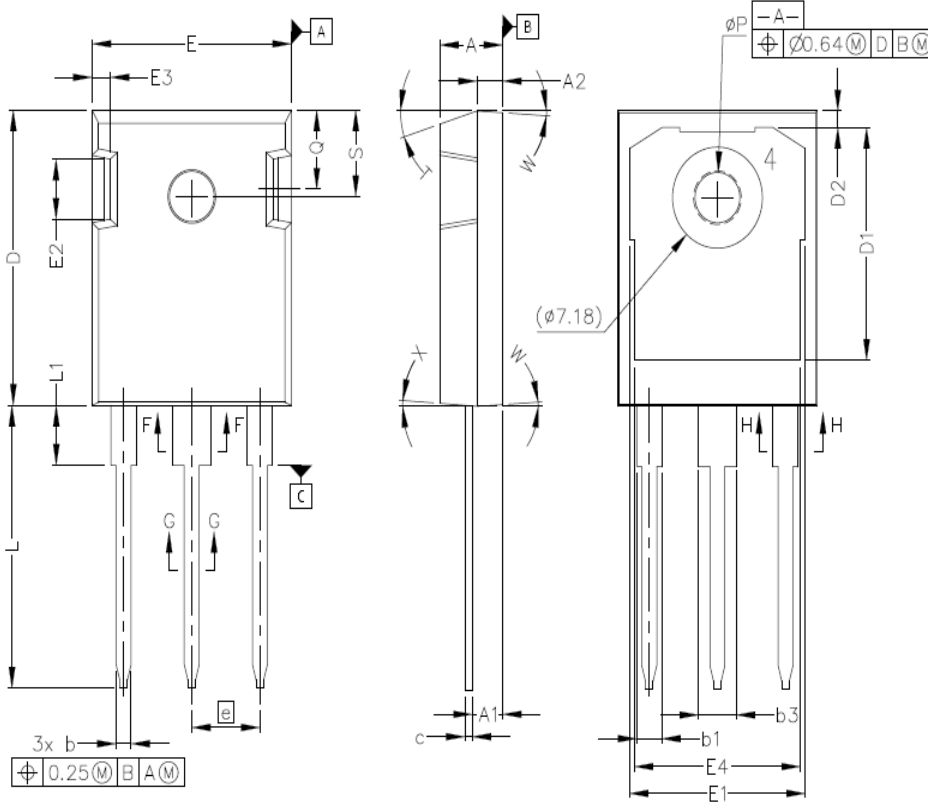

SYMBOL	MIN	MAX
A	4.83	5.21
A1	2.29	2.54
A2	1.91	2.16
b'	1.07	1.28
b	1.07	1.33
b1	1.91	2.41
b2	1.91	2.16
b3	2.87	3.38
b4	2.87	3.13
c'	0.55	0.65
c	0.55	0.68
D	20.80	21.10
D1	16.25	17.65
D2	0.95	1.25
E	15.75	16.13
E1	13.10	14.15
E2	3.68	5.10
E3	1.00	1.90
E4	12.38	13.43
e	5.44 BSC	
N	3	
L	19.81	20.32
L1	4.10	4.40
øP	3.51	3.65
Q	5.49	6.00
S	6.04	6.30
T	17.5° REF.	
W	3.5° REF.	
X	4° REF.	

Marking Information



Note:

CK2M080WMH = Product Name Code

XXXXXXX = Date Code

Contact ALKAIDSEMI sales for detail information

Revision History		
Revision	Release Date	Remark
Rev.1.8	2023/7/13	

Disclaimer

The information given in this document describes the independent performance of the product, but similar performance is not guaranteed under other working conditions, and cannot be guaranteed when installed with other products or equipment. To achieve the required performance of the product in actual scenarios, the customer should conduct a complete application test to assess the functionality of the product.

Alkaidsemi assumes no responsibility for equipment failures result from using products at values that exceed the ratings, operating conditions, or other parameters listed in the product specifications.

The product described in this specification is not applicable for aerospace or other applications which requires high reliability. Customers using or selling these products for use in medical, life-saving, or life-sustaining applications do so at their own risk and agree to fully indemnify.

Due to product or technical improvements, the information described or contained herein may be changed without prior notice.