

# 1200V 30mohm Silicon Carbide Power MOSFET AKCK2M032WAMH

## Features:

- High-speed switching performance
- low capacitances
- Fast intrinsic diode with low reverse recovery ( $Q_{RR}$ )
- Halogen-free, RoHS compliant <sup>(Note 1)</sup>

## Applications:

- EV motor drive
- DC/DC converters
- Switched mode power supplies
- Solar inverters
- OBC

## Key Performance Parameters:

Parameter	Value	Unit
$V_{DS}$	1200	V
$R_{DSON, TYP} @ V_{GS} = 18 V$	30	m $\Omega$
$I_D$	76	A
$P_D$	375	W

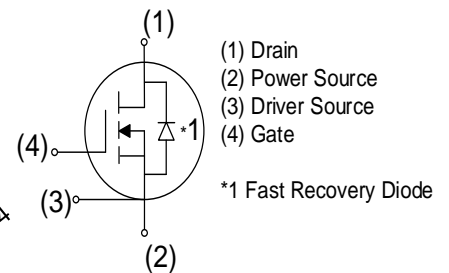
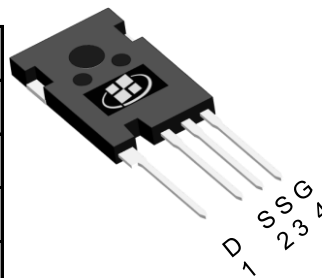

## Ordering Information:

Ordering Code	Package Type	Marking Code	Form	Packing
AKCK2M032WAMH	TO-247-4L	CK2M032WAMH	Tube	300 per box

## Notes:

1. Contact ALKAIDSEMI sales for detail information

**Maximum Ratings** ( $T_A = 25^\circ\text{C}$  unless otherwise noted)

Symbol	Parameter	Value	Units
$V_{DS}$	Drain-Source Voltage	1200	V
$I_D$	Drain Current - Continuous ( $T_C = 25^\circ\text{C}$ ) <sup>(Note 1)</sup>	76	A
	Drain Current - Continuous ( $T_C = 100^\circ\text{C}$ ) <sup>(Note 1)</sup>	68	A
$I_{DM}$	Drain Current - Pulsed <sup>(Note 2)</sup>	120	A
$V_{GS}$	Gate-Source Voltage (dynamic)	-10/+22	V
$V_{GS}$	Gate-Source Voltage (static)	-6/+18	V
$P_D$	Power Dissipation ( $T_C = 25^\circ\text{C}$ )	375	W
$T_J, T_{STG}$	Operating and Storage Temperature Range	-55 to +175	$^\circ\text{C}$

**Thermal Characteristics**

Symbol	Parameter	Value	Units
$R_{\theta JC}$	Thermal Resistance, Junction-to-Case, Steady-State	0.4	$^\circ\text{C}/\text{W}$
$R_{\theta JA}$	Thermal Resistance, Junction-to-Ambient, Steady-State	36	$^\circ\text{C}/\text{W}$

**Notes:**

1. The max drain current limited by maximum junction temperature
2. Repetitive Rating: Pulse width limited by maximum junction temperature

<b>Electrical Characteristics</b> ( $T_J = 25^\circ\text{C}$ unless otherwise noted)						
Symbol	Parameter	Test Conditions	Min	Typ	Max	Units
<b>Static Characteristics</b>						
$BV_{DSS}$	Drain-Source Breakdown Voltage	$V_{GS} = 0\text{ V}, I_D = 100\ \mu\text{A}$	1200			V
$I_{DSS}$	Zero Gate Voltage Drain Current	$V_{DS} = 1200\text{ V}, V_{GS} = 0\text{ V}$		5	50	$\mu\text{A}$
$I_{GSS}$	Gate Leakage Current	$V_{GS} = +18\text{ V}, V_{DS} = 0\text{ V}$			100	nA
		$V_{GS} = -6\text{ V}, V_{DS} = 0\text{ V}$			100	nA
$V_{GS(TH)}$	Gate Threshold voltage	$V_{DS} = V_{GS}, I_D = 11.5\text{ mA}$	2.2	3.2	4.5	V
		$V_{DS} = V_{GS}, I_D = 11.5\text{ mA}, T_J = 175^\circ\text{C}$		2.2		V
$R_{DS(ON)}$	Drain-Source on-state resistance	$V_{GS} = 18\text{ V}, I_D = 40\text{ A}$	20	30	40	m $\Omega$
		$V_{GS} = 18\text{ V}, I_D = 40\text{ A}, T_J = 175^\circ\text{C}$		48		m $\Omega$
$G_{FS}$	Forward Transconductance	$V_{DS} = 20\text{ V}, I_D = 40\text{ A}$		27		S
		$V_{DS} = 20\text{ V}, I_D = 40\text{ A}, T_J = 175^\circ\text{C}$		17		S
<b>Dynamic Characteristics</b>						
$C_{ISS}$	Input Capacitance	$V_{DS} = 800\text{ V}, V_{GS} = 0\text{ V}, F = 100\text{ kHz}, V_{AC} = 25\text{ mV}$		2940		pF
$C_{OSS}$	Output Capacitance			129		pF
$C_{RSS}$	Reverse Transfer Capacitance			15		pF
$E_{OSS}$	$C_{OSS}$ Stored Energy			80		$\mu\text{J}$
$R_G$	Gate Resistance	$F = 1\text{ MHz}, V_{AC} = 25\text{ mV}$		2.2		$\Omega$
$Q_{GS}$	Gate-Source Charge	$V_{DS} = 800\text{ V}, I_D = 40\text{ A}, V_{GS} = -5/+18\text{ V}$		34		nC
$Q_{GD}$	Gate-Drain Charge			35		nC
$Q_G$	Total Gate Charge			138		nC

Switching Characteristics (Note3)							
Symbol	Parameter	Test Conditions	Min	Typ	Max	Units	
$T_{D(ON)}$	Turn On Delay Time	$V_{DD} = 800\text{ V}$ , $I_D = 40\text{ A}$ , $V_{GS} = -5/+18\text{ V}$ , $R_{G,EXT} = 2.5\ \Omega$ $L = 99\ \mu\text{H}$  Diode: Body Diode at $V_{GS} = -5\text{V}$		14		nS	
$T_R$	Rise Time			31		nS	
$T_{D(OFF)}$	Turn Off Delay Time			32		nS	
$T_F$	Fall Time			12		nS	
$E_{ON}$	Turn On Energy				1278		$\mu\text{J}$
$E_{OFF}$	Turn Off Energy				154		$\mu\text{J}$
$T_{D(ON)}$	Turn On Delay Time	$V_{DD} = 800\text{ V}$ , $I_D = 40\text{ A}$ , $V_{GS} = -5/+18\text{ V}$ , $R_{G,EXT} = 2.5\ \Omega$ $L = 99\ \mu\text{H}$  Diode: Body Diode at $V_{GS} = -5\text{V}$ $T_J = 175\text{ }^\circ\text{C}$		12		nS	
$T_R$	Rise Time			32		nS	
$T_{D(OFF)}$	Turn Off Delay Time			37		nS	
$T_F$	Fall Time			13		nS	
$E_{ON}$	Turn On Energy				1616		$\mu\text{J}$
$E_{OFF}$	Turn Off Energy				178		$\mu\text{J}$

Note3: All switching characteristics reference TO247-3L.

### Drain-Source Diode Characteristics ( $T_J = 25\text{ }^\circ\text{C}$ unless otherwise noted)

$I_S$	Maximum Continuous Drain-Source Diode Forward Current			68		A
$I_{SM}$	Maximum Pulsed Drain-Source Diode Forward Current			140		A
$V_{SD}$	Diode Forward Voltage	$V_{GS} = -4\text{ V}$ , $I_{SD} = 20\text{ A}$		4.9		V
		$V_{GS} = -4\text{ V}$ , $I_{SD} = 20\text{ A}$ , $T_J = 175\text{ }^\circ\text{C}$		4.4		V
$I_{RM}$	Peak Reverse Recovery Current	$V_{GS} = -4\text{ V}$ , $I_{SD} = 40\text{ A}$ , $V_R = 800\text{ V}$ , $di/dt = 1150\text{ A}/\mu\text{S}$		12		A
$T_{RR}$	Reverse Recovery Time			61		nS
$Q_{RR}$	Reverse Recovery Charge			367		nC
$I_{RM}$	Peak Reverse Recovery Current	$V_{GS} = -4\text{ V}$ , $I_{SD} = 40\text{ A}$ , $V_R = 800\text{ V}$ , $di/dt = 1150\text{ A}/\mu\text{S}$ $T_J = 175\text{ }^\circ\text{C}$		20		A
$T_{RR}$	Reverse Recovery Time			55		nS
$Q_{RR}$	Reverse Recovery Charge			825		nC

# Electrical Characteristics Diagrams (Note4)

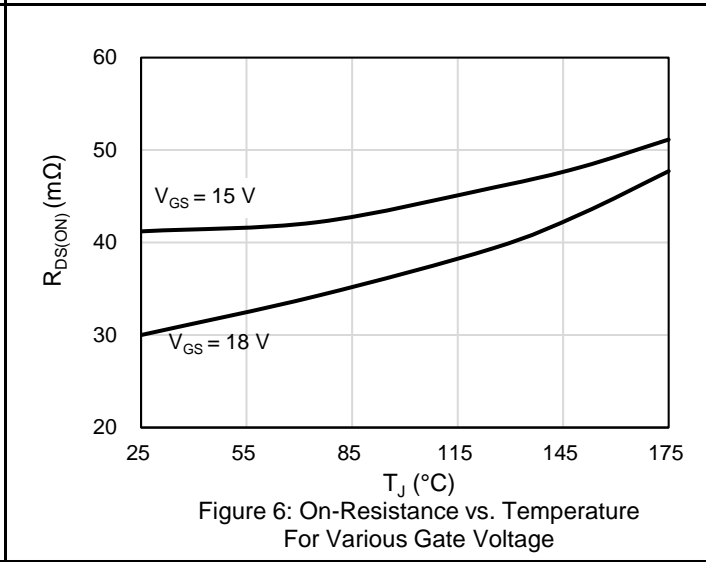
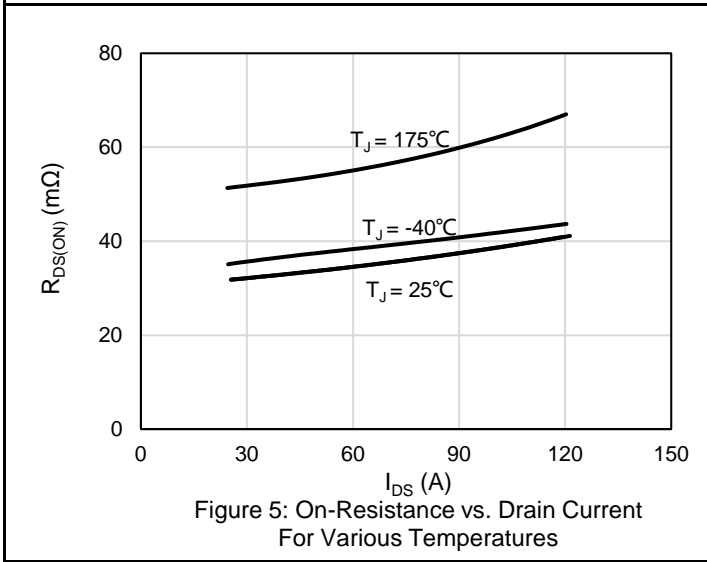
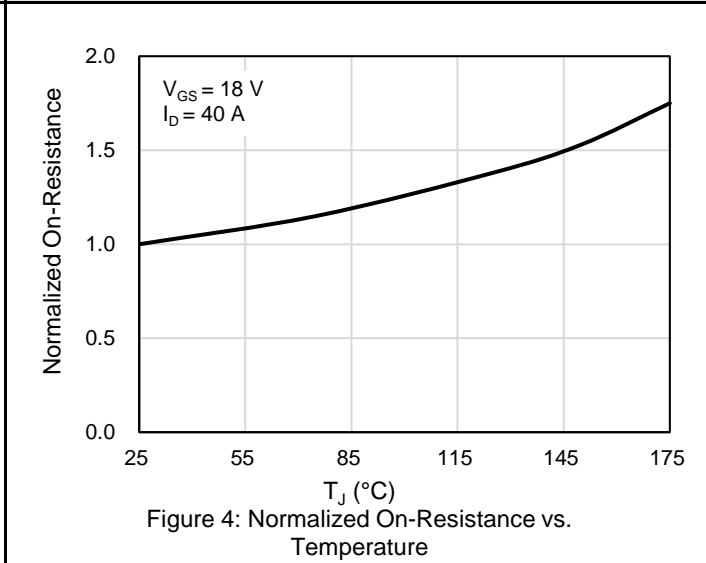
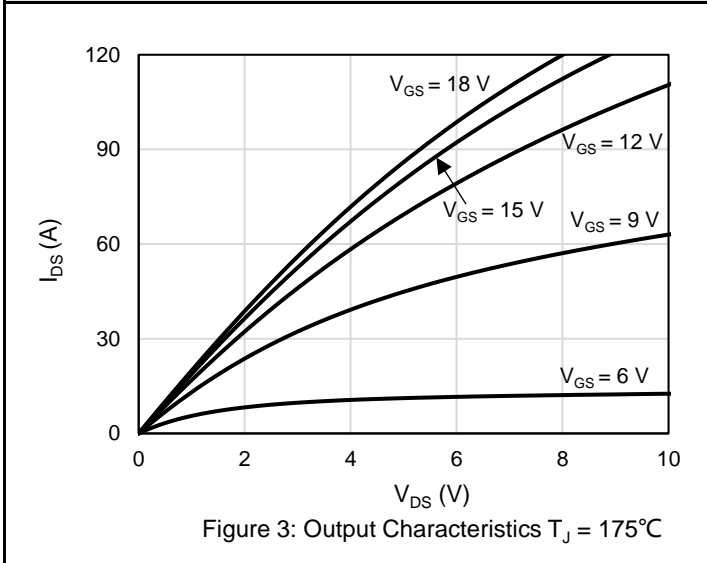
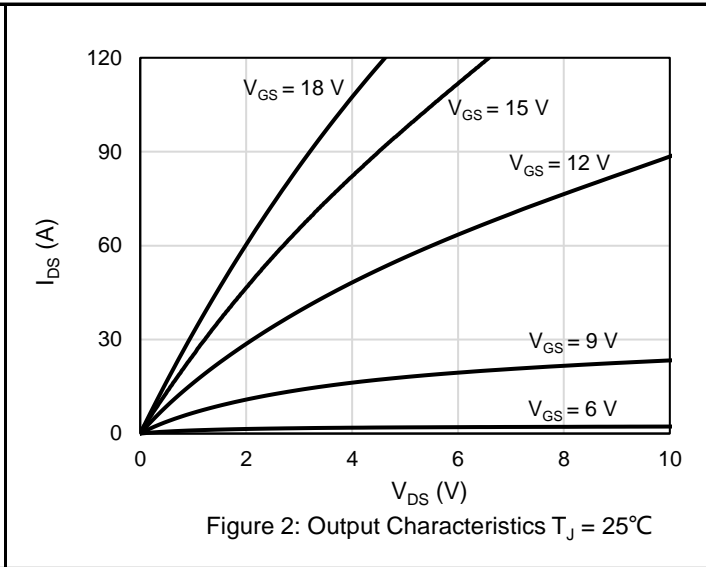
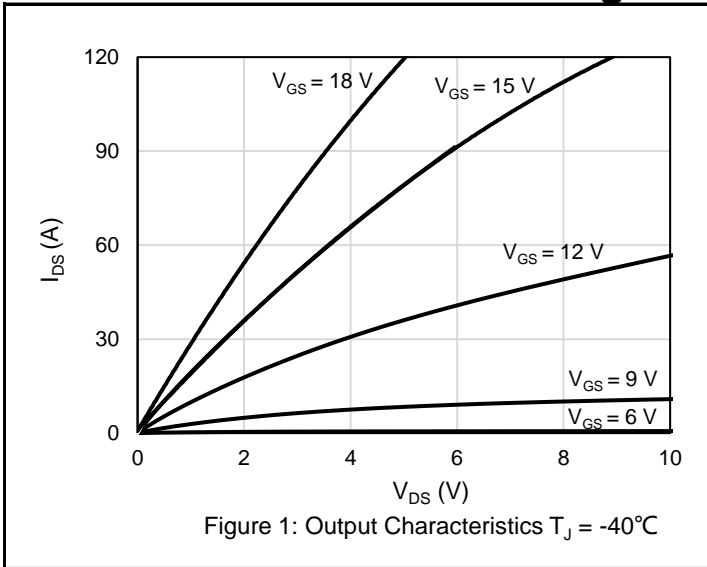

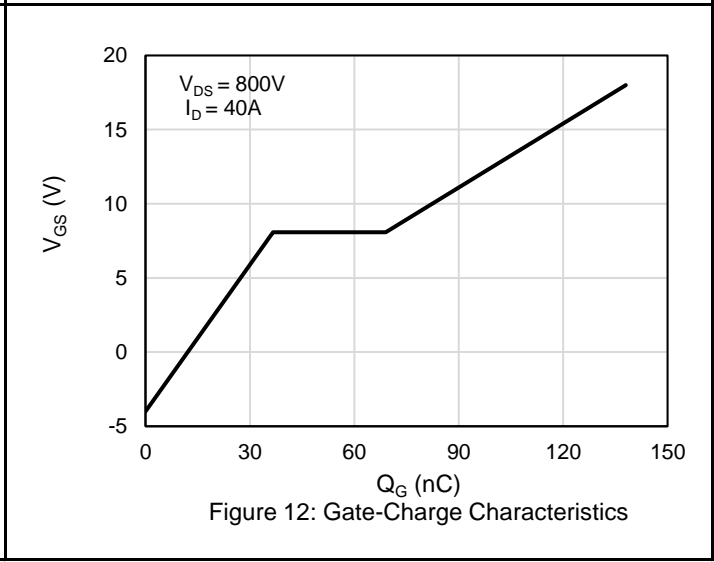
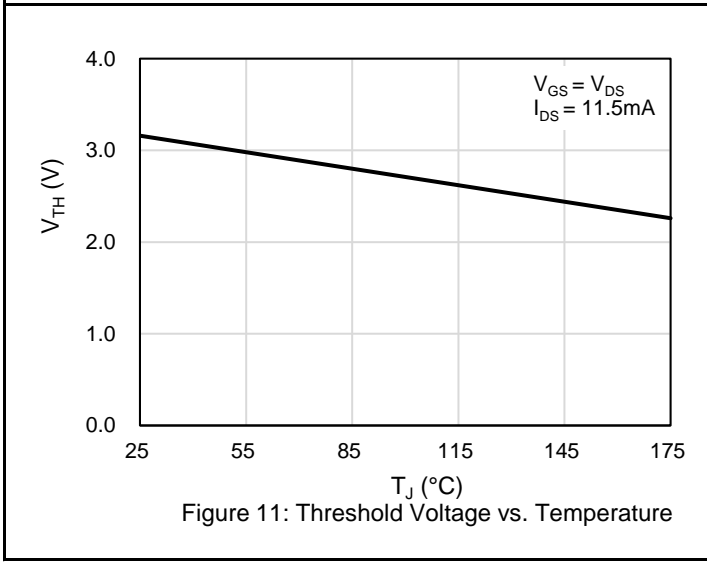
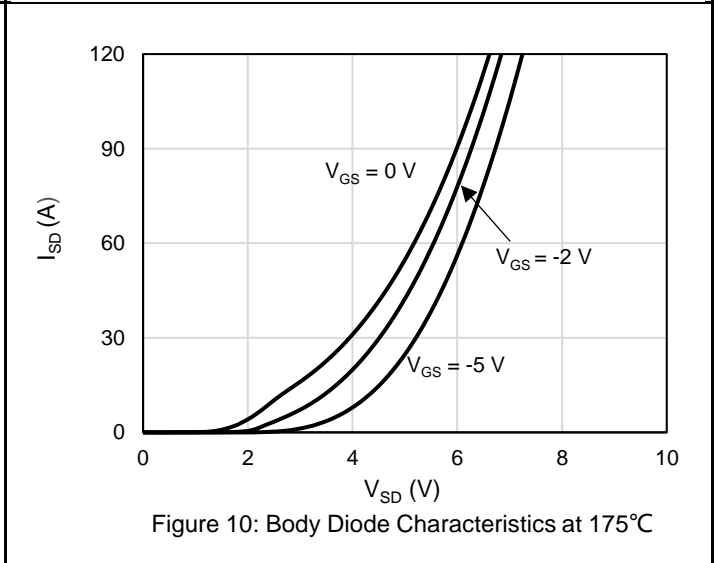
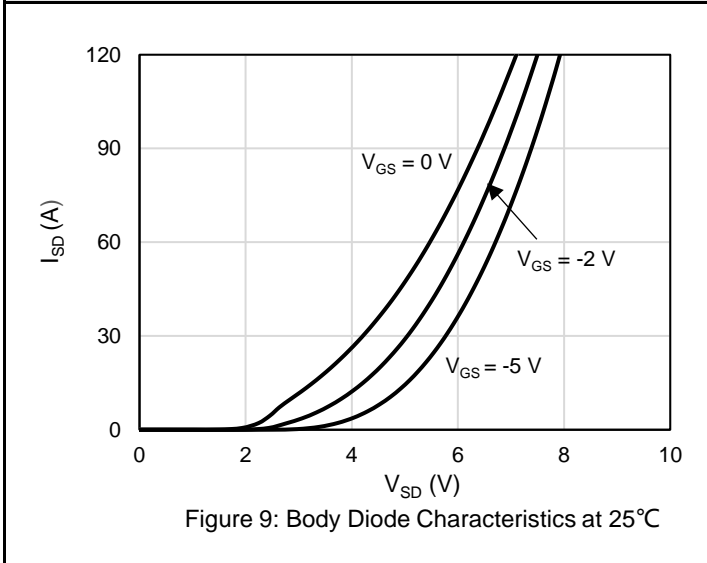
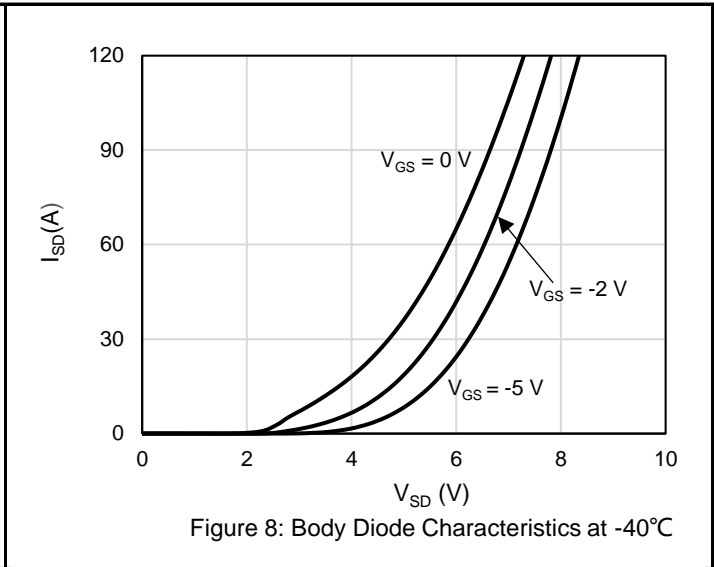
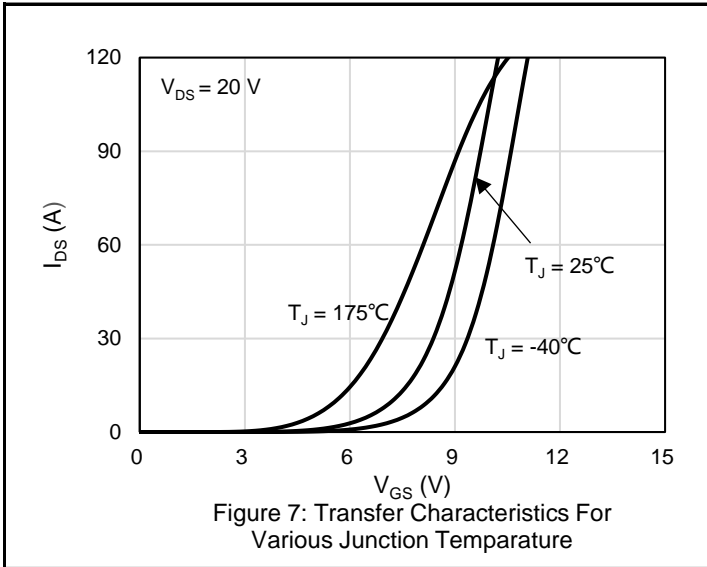

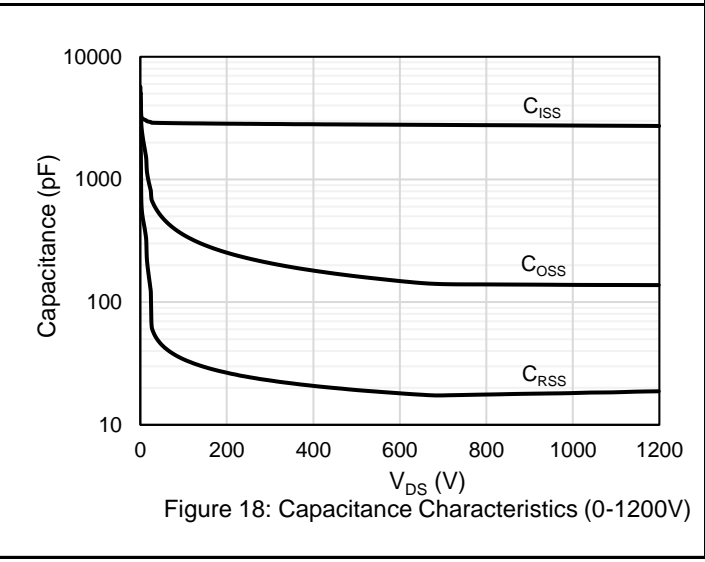
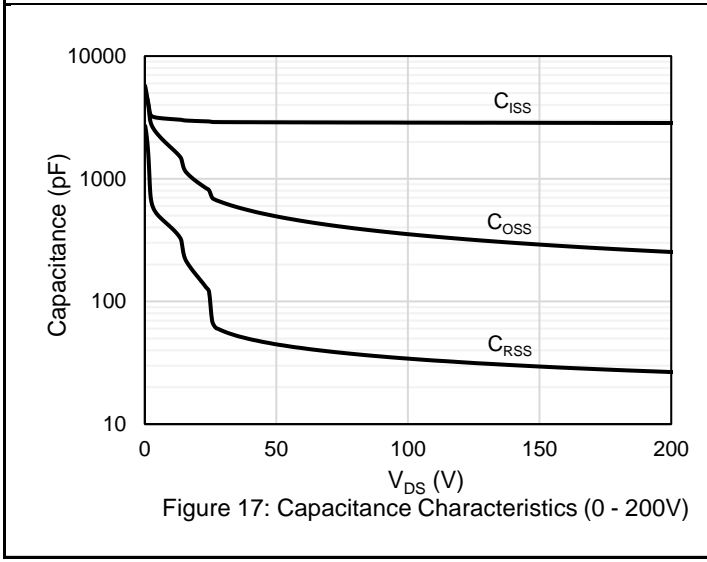
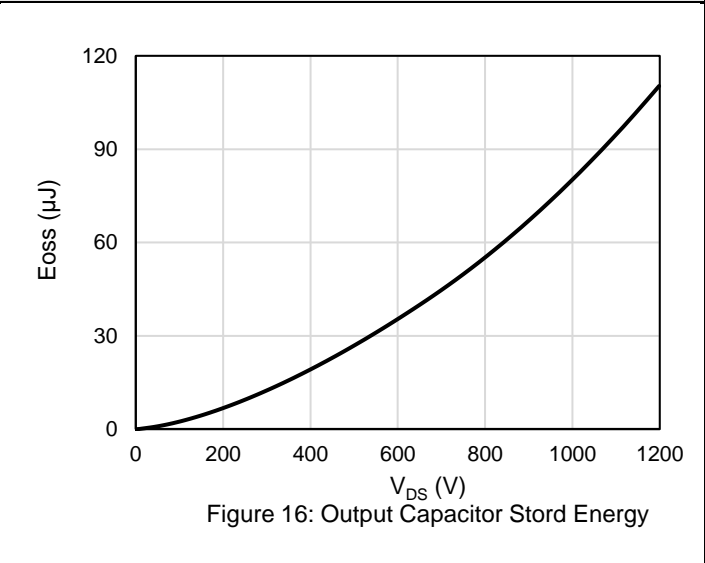
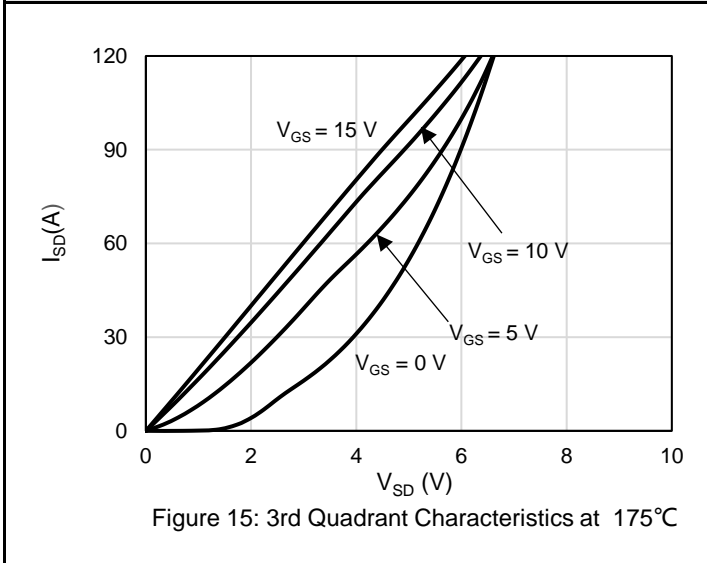
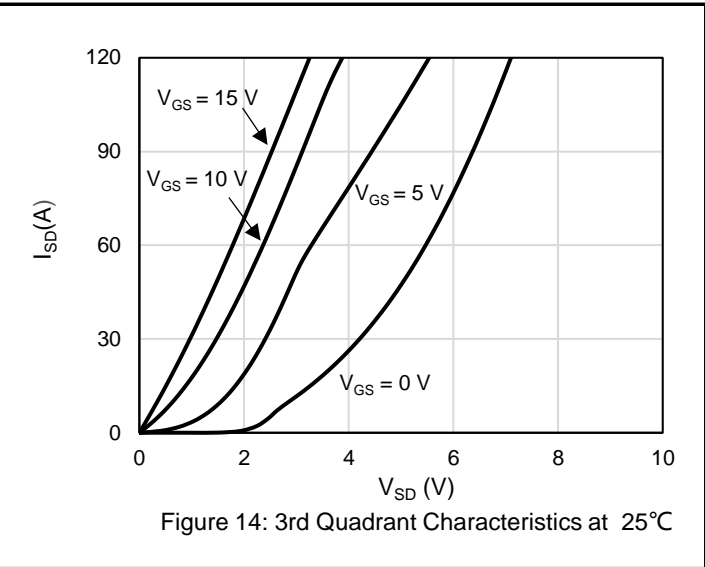
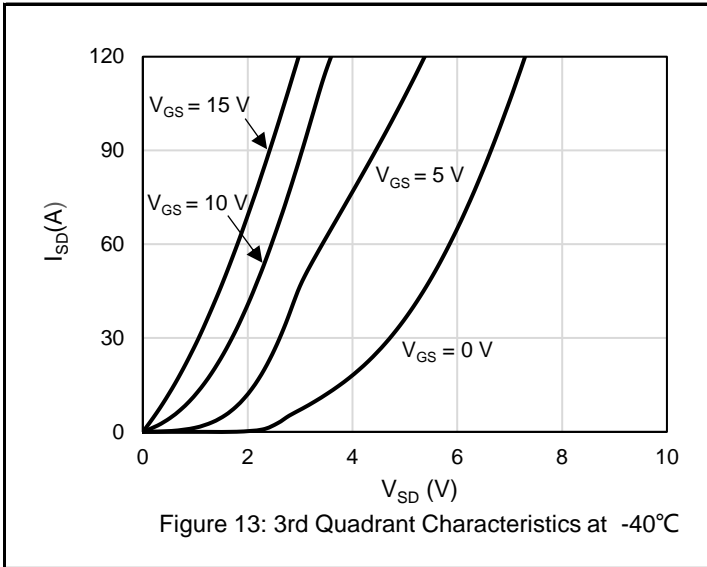

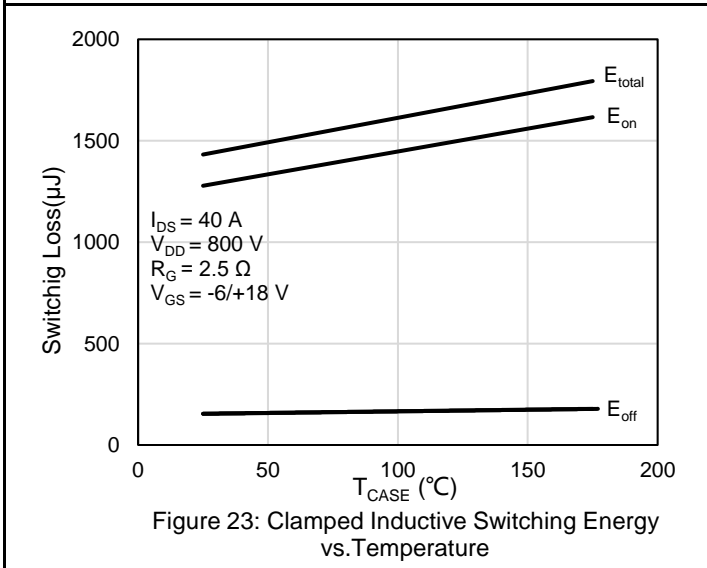
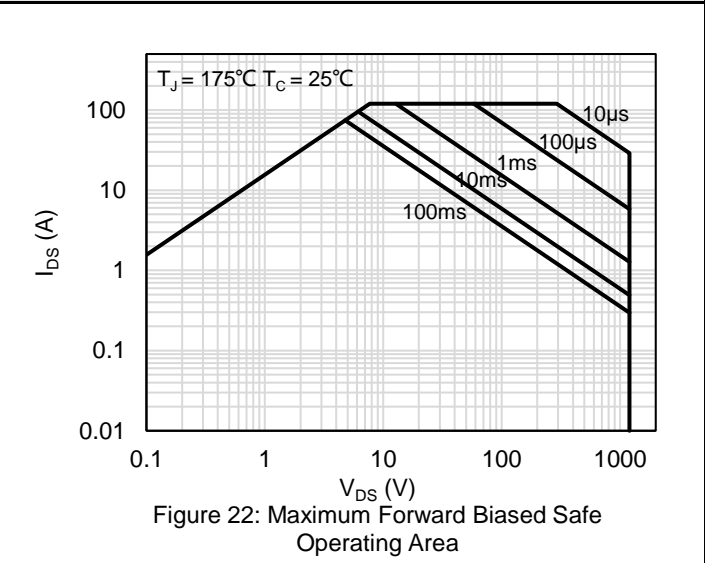
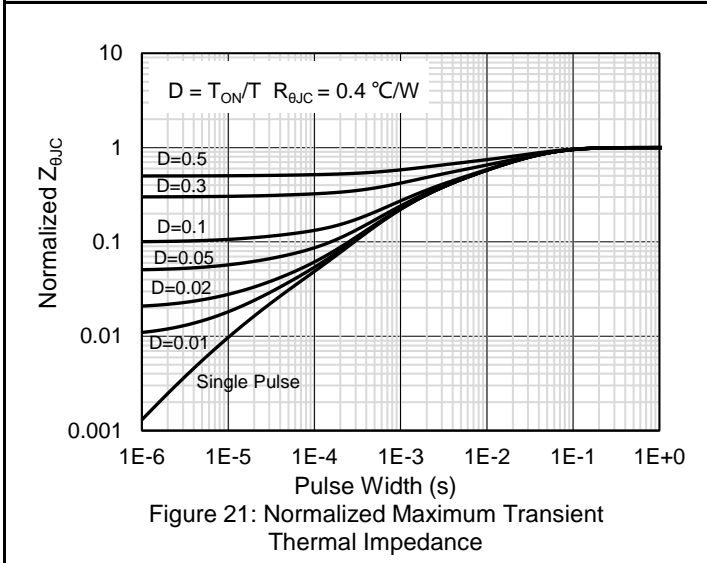
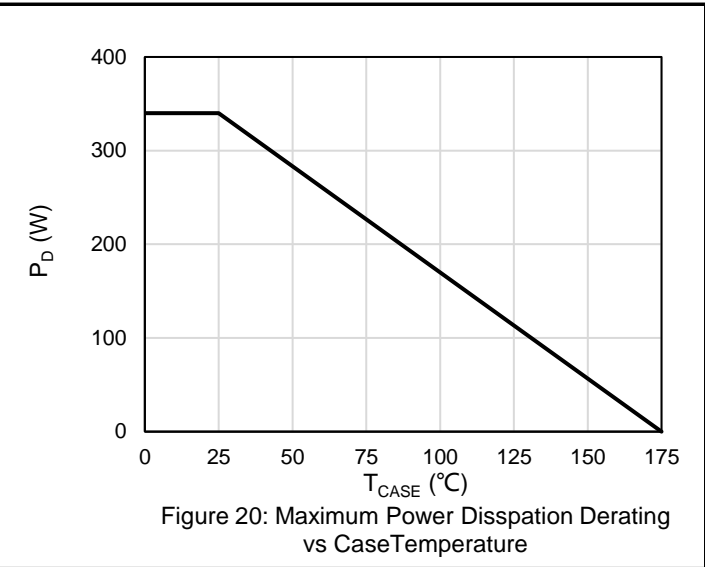
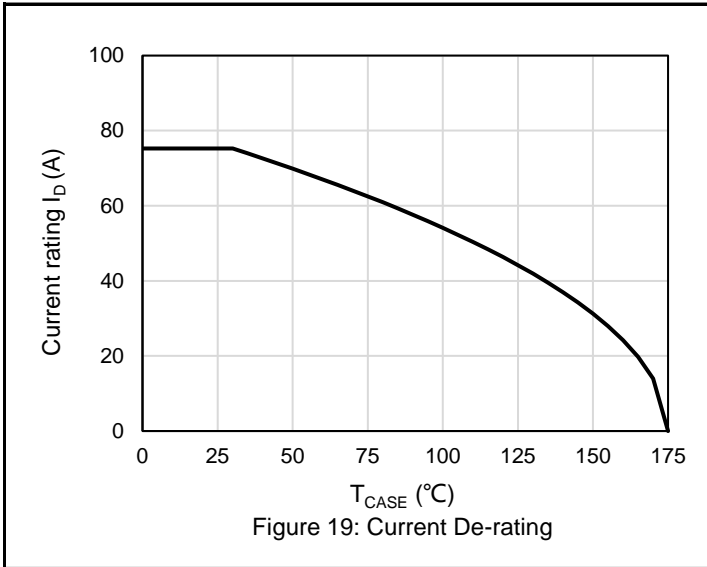

Note4: All figures reference TO247-3L.



# Test Circuit and Waveform

Gate Charge Test Circuit & Waveform

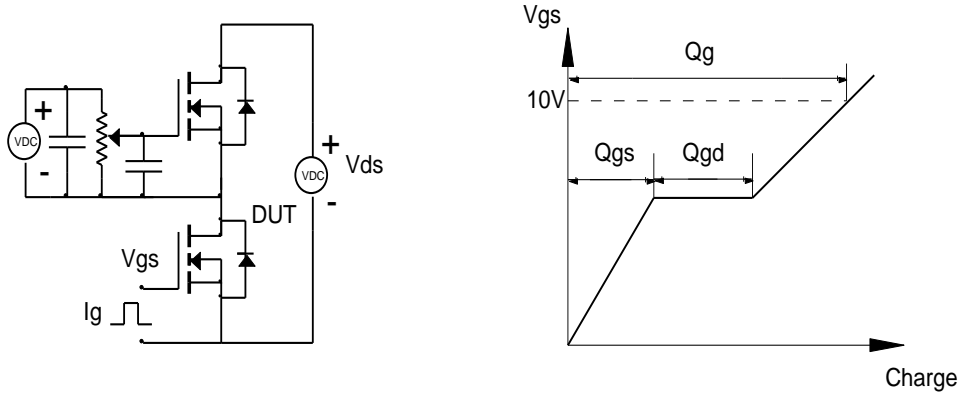

Clamped Inductive Switching Test Circuit & Waveforms

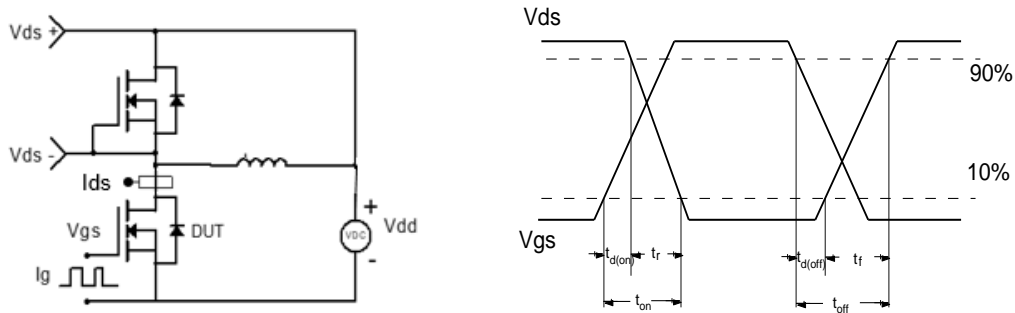

Diode Recovery Test Circuit & Waveforms

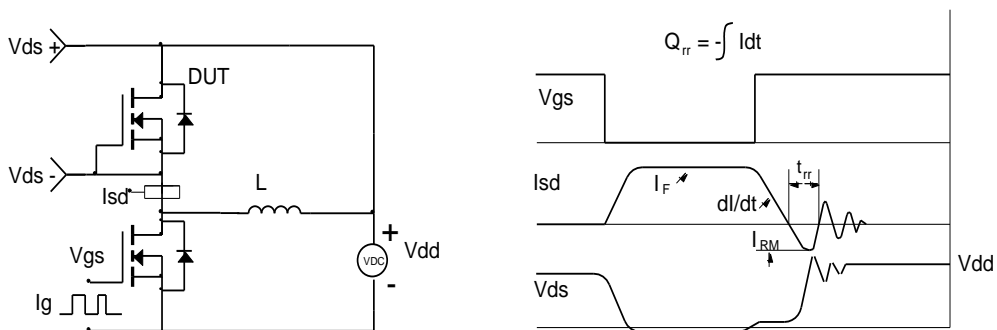

Package Outlines

TO-247-4L PKG Outlines

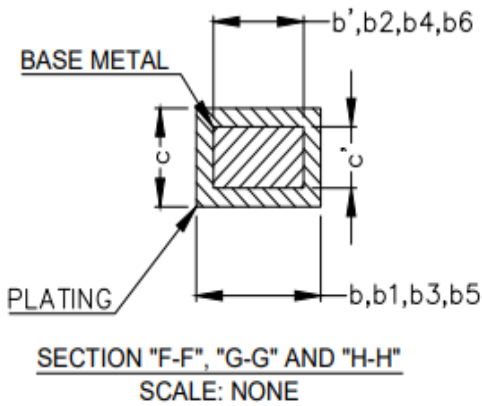
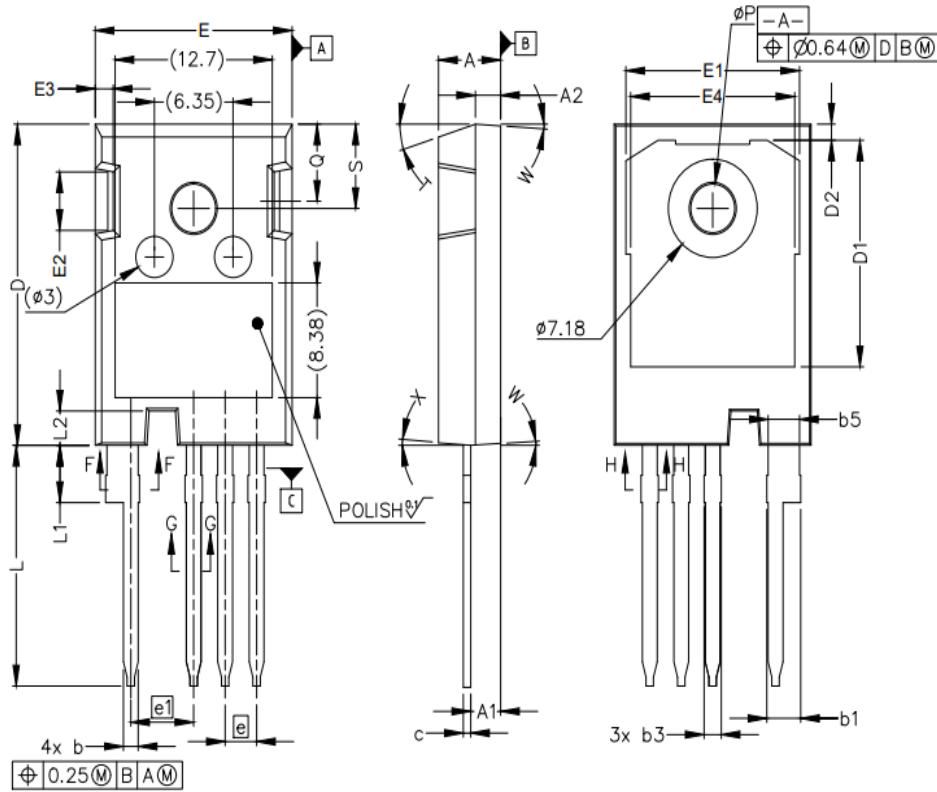

SYMBOL	MILLIMETERS	
	MIN	MAX
A	4.83	5.21
A1	2.29	2.54
A2	1.91	2.16
b'	1.07	1.28
b	1.07	1.33
b1	2.39	2.94
b2	2.39	2.84
b3	1.07	1.60
b4	1.07	1.50
b5	2.39	2.69
b6	2.39	2.64
c'	0.55	0.65
c	0.55	0.68
D	23.30	23.60
D1	16.25	17.65
D2	0.95	1.25
E	15.75	16.13
E1	13.10	14.15
E2	3.68	5.10
E3	1.00	1.90
E4	12.38	13.43
e	2.54 BSC	
e1	5.08 BSC	
N	4	
L	17.31	17.82
L1	3.97	4.37
L2	2.35	2.65
øP	3.51	3.65
Q	5.49	6.00
S	6.04	6.30
T	17.5° REF.	
W	3.5° REF.	
X	4° REF.	

## Marking Information



Note:

CK2M032WAMH = Product Name Code

XXXXXXX = Date Code

Contact ALKAIDSEMI sales for detail information

## Revision History

Revision	Release Date	Remark
Rev.1.2	2023/7/13	

## Disclaimer

The information given in this document describes the independent performance of the product, but similar performance is not guaranteed under other working conditions, and cannot be guaranteed when installed with other products or equipment. To achieve the required performance of the product in actual scenarios, the customer should conduct a complete application test to assess the functionality of the product.

Alkaidsemi assumes no responsibility for equipment failures result from using products at values that exceed the ratings, operating conditions, or other parameters listed in the product specifications.

The product described in this specification is not applicable for aerospace or other applications which requires high reliability. Customers using or selling these products for use in medical, life-saving, or life-sustaining applications do so at their own risk and agree to fully indemnify.

Due to product or technical improvements, the information described or contained herein may be changed without prior notice.