

100V 3.8mohm N-channel SGT MOSFET

AKG10N038DM

Description:

This N channel SGT MOSFET has been designed to low on-state resistance and maintain superior switching performance, especially for high efficiency power management applications.

Features:

- Low $R_{DS(ON)}$
- RoHS compliant
- Halogen-free
- 100% UIS tested

Applications:

- Power Management Switches
- DC-DC Converter
- Battery Management System

Key Performance Parameters:

Parameter	Value	Unit
V_{DS}	100	V
$R_{DS(ON), max} @V_{GS} = 10 V$	3.8	m Ω
I_D	185	A

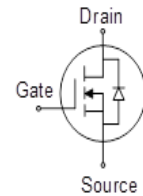
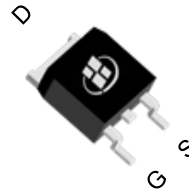

Ordering Information:

Ordering Code	Package Type	Marking Code	Form	Packing
AKG10N038DM	TO-263	G10N038DM	Tape Reel	1000 per reel

Maximum Ratings $(T_A = 25^\circ\text{C}$ unless otherwise noted)

Symbol	Parameter	Value	Units
V_{DS}	Drain-Source Voltage	100	V
I_D	Drain Current - Continuous $(T_C = 25^\circ\text{C})$ ^(Note 1)	185	A
	Drain Current - Continuous $(T_C = 100^\circ\text{C})$	117	A
I_{DM}	Drain Current - Pulsed ^(Note 2)	740	A
V_{GS}	Gate-Source Voltage	± 20	V
E_{AS}	Single Pulsed Avalanche Energy ^(Note 3)	441	mJ
P_D	Power Dissipation $(T_C = 25^\circ\text{C})$	208	W
T_J, T_{STG}	Operating and Storage Temperature Range	-55 to +150	$^\circ\text{C}$

Thermal Characteristics

Symbol	Parameter	Value	Units
$R_{\theta JC}$	Thermal Resistance, Junction-to-Case, Steady-State	0.6	$^\circ\text{C}/\text{W}$
$R_{\theta JA}$	Thermal Resistance, Junction-to-Ambient, Steady State ^(Note 4)	50	$^\circ\text{C}/\text{W}$

Notes:

1. The max drain current rating is silicon limited
2. Repetitive Rating: Pulse width limited by maximum junction temperature
3. $L = 0.5$ mH, $V_{DD} = 50$ V, $I_{AS} = 42$ A, $R_g = 50$ Ω , Starting $T_J = 25$ $^\circ\text{C}$
4. Mount on minimum PCB layout

Electrical Characteristics (T _J = 25°C unless otherwise noted)						
Symbol	Parameter	Test Conditions	Min	Typ	Max	Units
Static Characteristics						
V _{(BR)DSS}	Drain-Source Breakdown Voltage	V _{GS} = 0 V, I _D = 250 μA	100			V
I _{DSS}	Zero Gate Voltage Drain Current	V _{DS} = 100 V, V _{GS} = 0 V,			1	μA
I _{GSS}	Gate Leakage Current	V _{GS} = ± 20 V, V _{DS} = 0 V			±100	nA
V _{GS(th)}	Gate Threshold voltage	V _{DS} = V _{GS} , I _D = 250 μA	2	2.7	4	V
R _{DS(ON)}	Drain-Source on-state resistance	V _{GS} = 10 V, I _D = 20 A		3.3	3.8	mΩ
Dynamic Characteristics						
C _{iss}	Input Capacitance	V _{DS} = 50 V, V _{GS} = 0 V, f = 1 MHz		8845		pF
C _{oss}	Output Capacitance			1680		pF
C _{rss}	Reverse Transfer Capacitance			57		pF
R _g	Gate Resistance	f = 1 MHz		1.9		Ω
Switching Characteristics						
t _{d(on)}	Turn On Delay Time	V _{DD} = 50 V, R _L = 2.5 Ω, V _{GS} = 10 V, R _G = 6 Ω		37		ns
t _r	Rise Time			53		ns
t _{d(off)}	Turn Off Delay Time			127		ns
t _f	Fall Time			74		ns
Q _g	Total Gate Charge	V _{DD} = 50 V, I _D = 20 A, V _{GS} = 10 V		128		nC
Q _{gs}	Gate-Source Charge			32		nC
Q _{gd}	Gate-Drain Charge			25		nC
Drain-Source Diode Characteristics and Maximum Ratings						
I _S	Maximum Continuous Body-Diode Forward Current				185	A
I _{SM}	Maximum Pulsed Body-Diode Forward Current				740	A
V _{SD}	Diode Forward Voltage	V _{GS} = 0 V, I _S = 1 A		0.62		V
t _{rr}	Reverse recovery time	V _{DD} = 50 V, I _D = 20 A, di/dt = 100 A/μS		82		ns
Q _{rr}	Reverse recovery charge			202		nC
I _{rrm}	Peak Reverse Recovery Current			4		A

Electrical Characteristics Diagrams

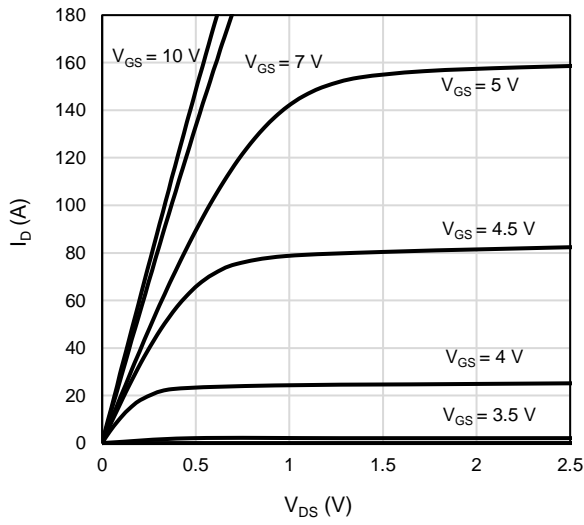

Figure 1: On-Region Characteristics

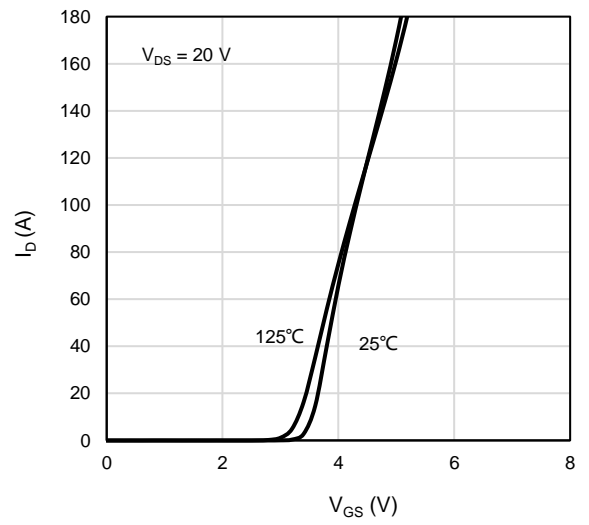

Figure 2: Transfer Characteristics

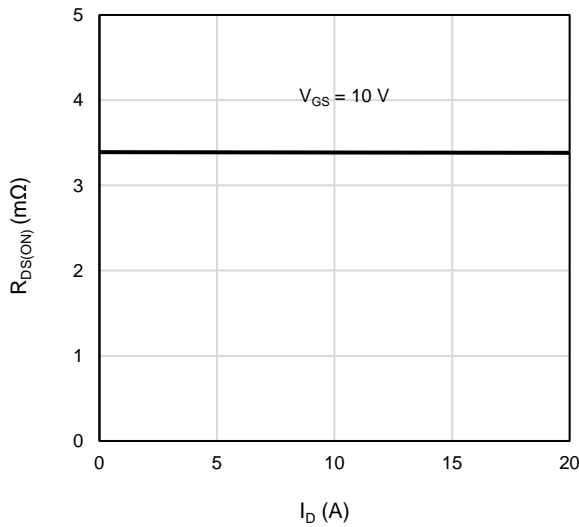

Figure 3: On-Resistance vs. Drain Current and Gate Voltage

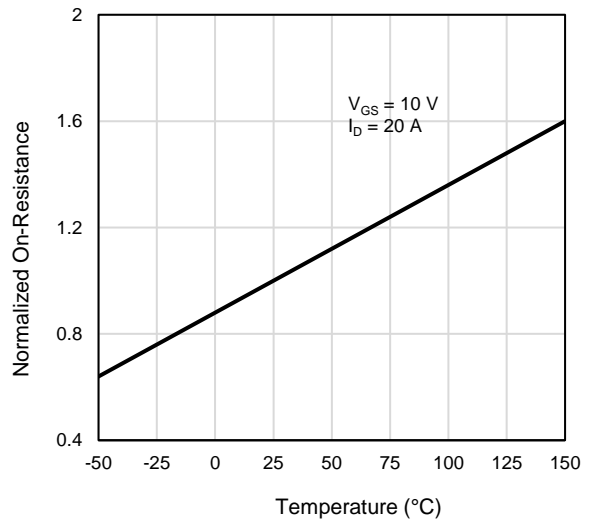

Figure 4: On-Resistance vs. Junction Temperature

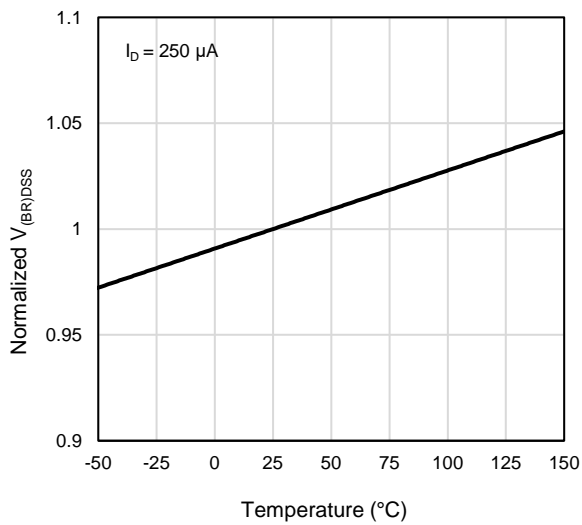

Figure 5: Breakdown Voltage vs. Junction Temperature

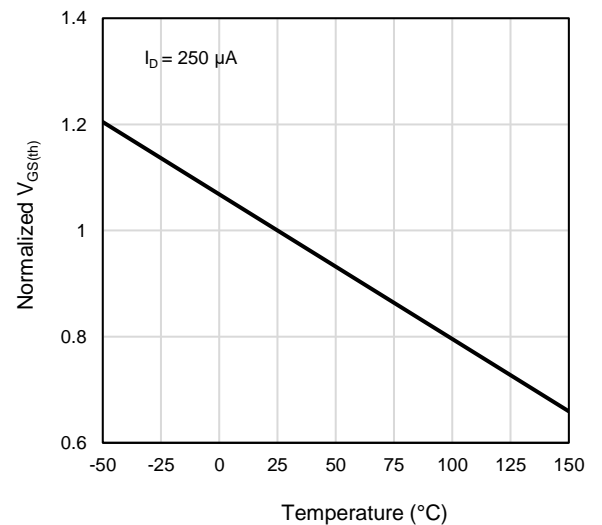

Figure 6: Threshold Voltage vs. Junction Temperature

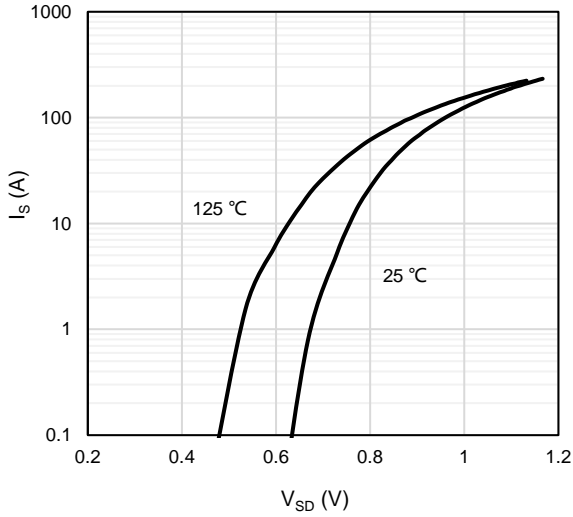

Figure 7: Body-Diode Characteristics

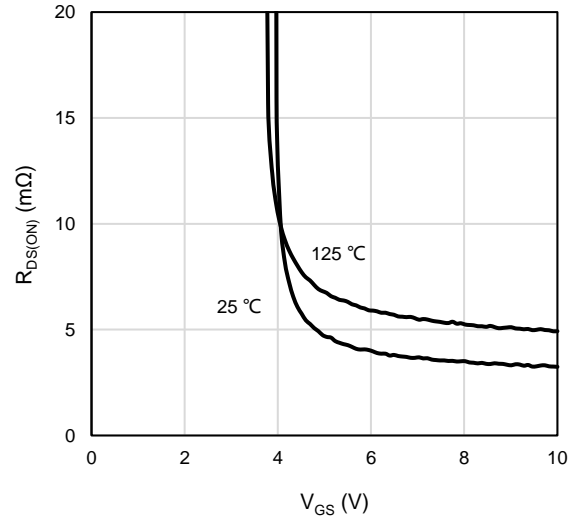

Figure 8: On-Resistance vs. Gate-Source Voltage

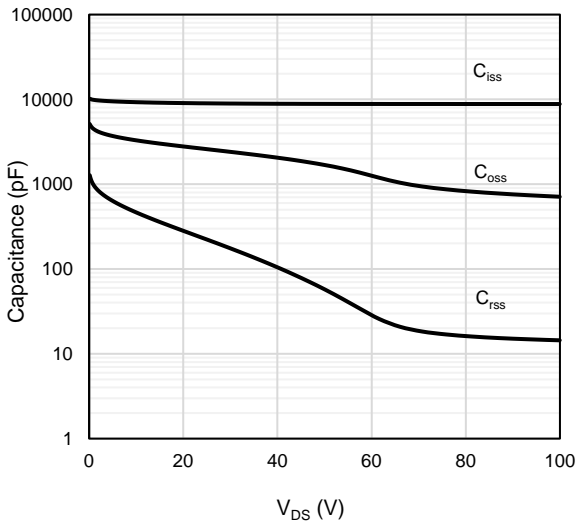

Figure 9: Capacitance Characteristics

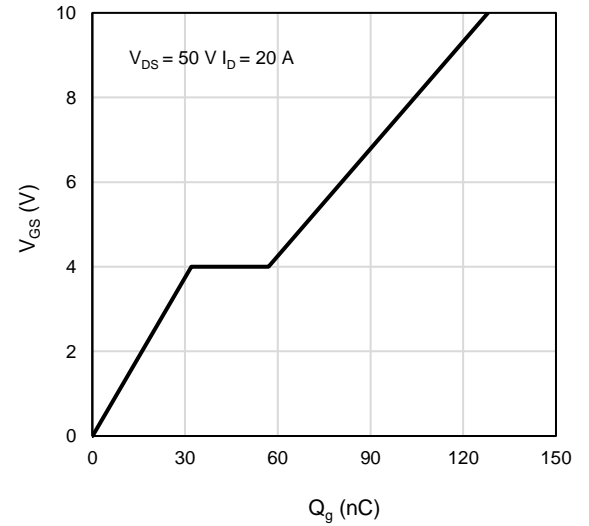

Figure 10: Gate-Charge Characteristics

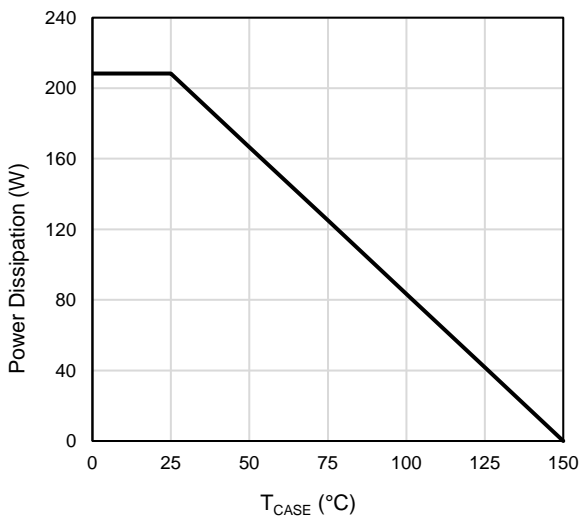

Figure 11: Power De-rating

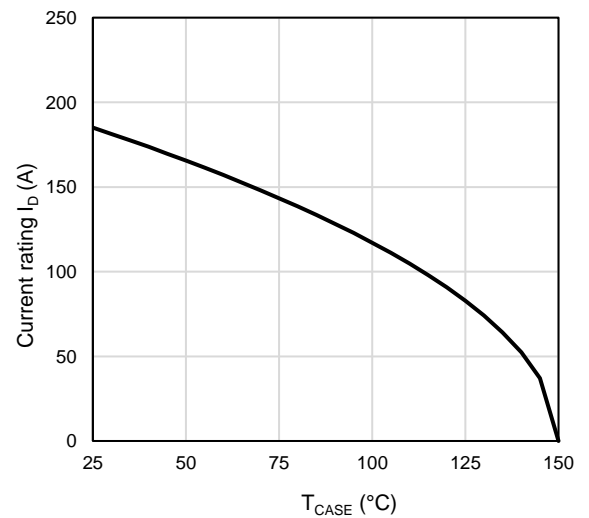

Figure 12: Current De-rating

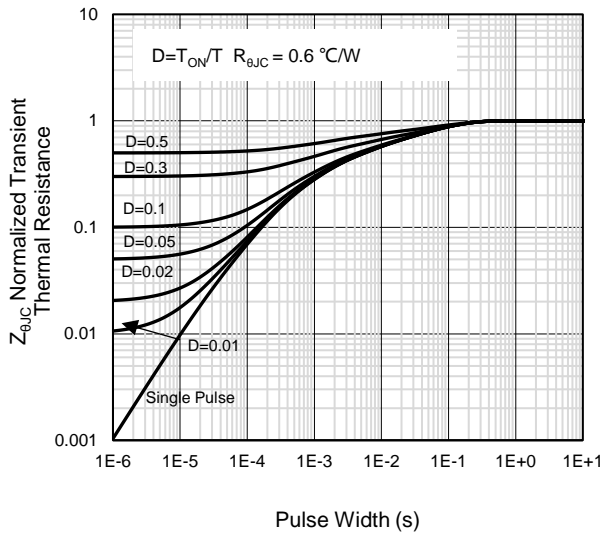

Figure 13: Normalized Maximum Transient Thermal Impedance

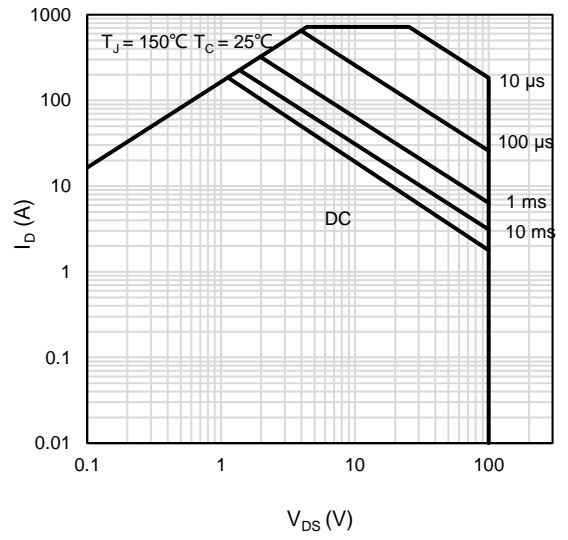
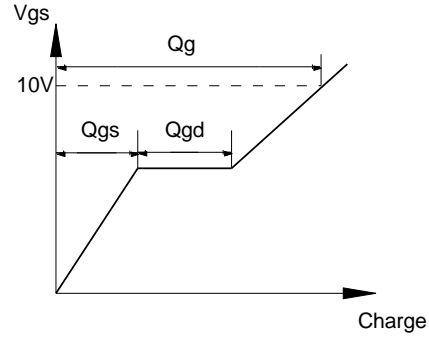
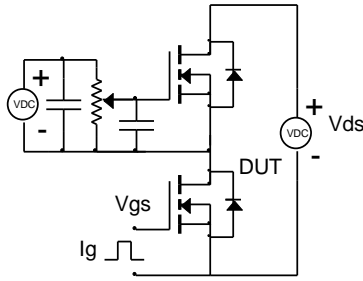

Figure 14: Maximum Forward Biased Safe Operating Area

Test Circuit and Waveform

Gate Charge Test Circuit & Waveform



Resistive Switching Test Circuit & Waveforms

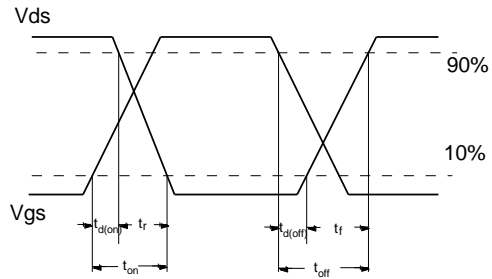
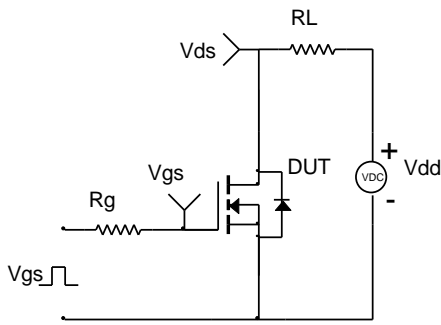

Unclamped Inductive Switching (UIS) Test Circuit & Waveforms

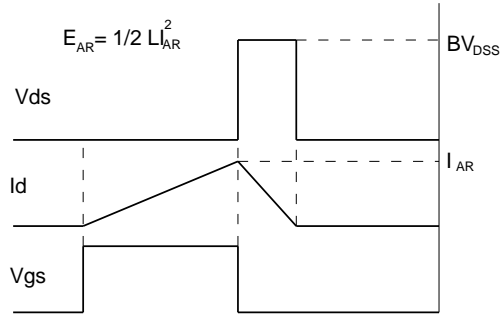
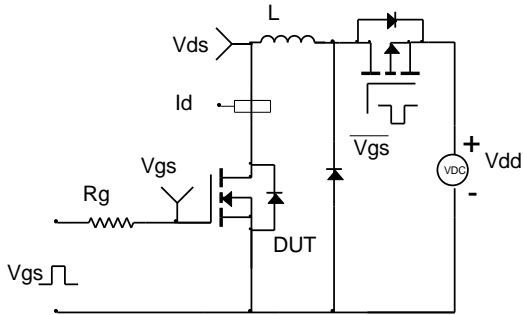

Diode Recovery Test Circuit & Waveforms

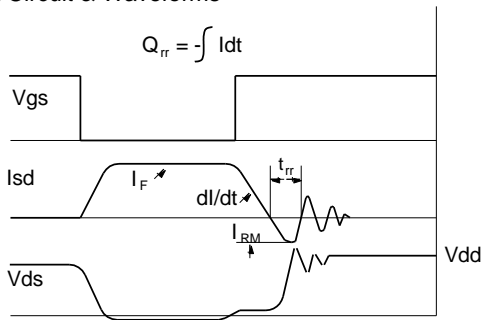
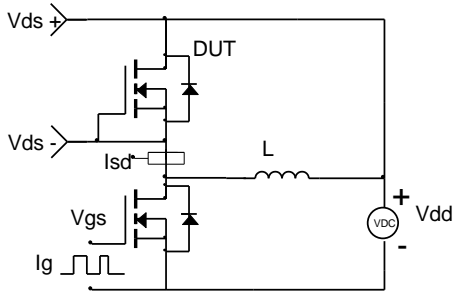

Package Outlines

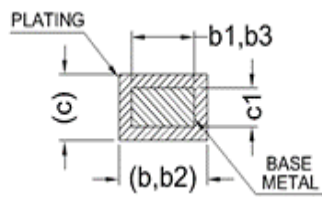
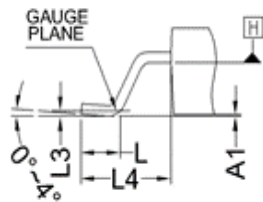
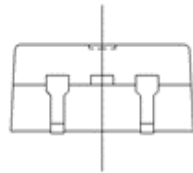
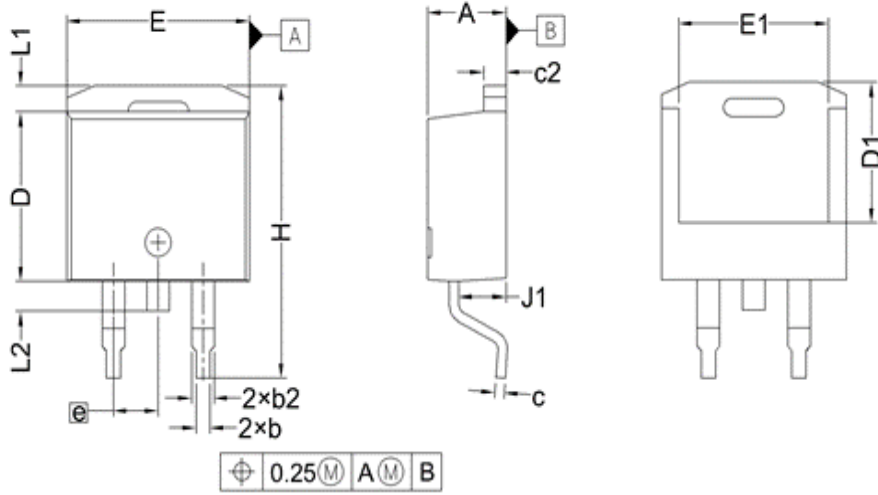

SYMBOL	MIN	MAX
A	4.36	4.56
A1	0.00	0.25
b	0.70	0.90
b1	0.51	0.89
b2	1.17	1.37
b3	1.17	1.37
c	0.38	0.69
c1	0.38	0.53
c2	1.19	1.34
D	8.60	9.00
D1	6.90	7.50
E	10.15	10.55
E1	8.10	8.70
e	2.54 BSC	
H	15.00	15.60
L	1.90	2.50
L1	-	1.65
L2	-	1.78
L3	0.25 TYP	
L4	4.78	5.28
J1	2.56	2.96

Marking Information



Note:

G10N038DM = Product Name Code

XXXXXXX = Date code

Contact ALKAIDSEMI sales for detail information

Tape & Reel Information

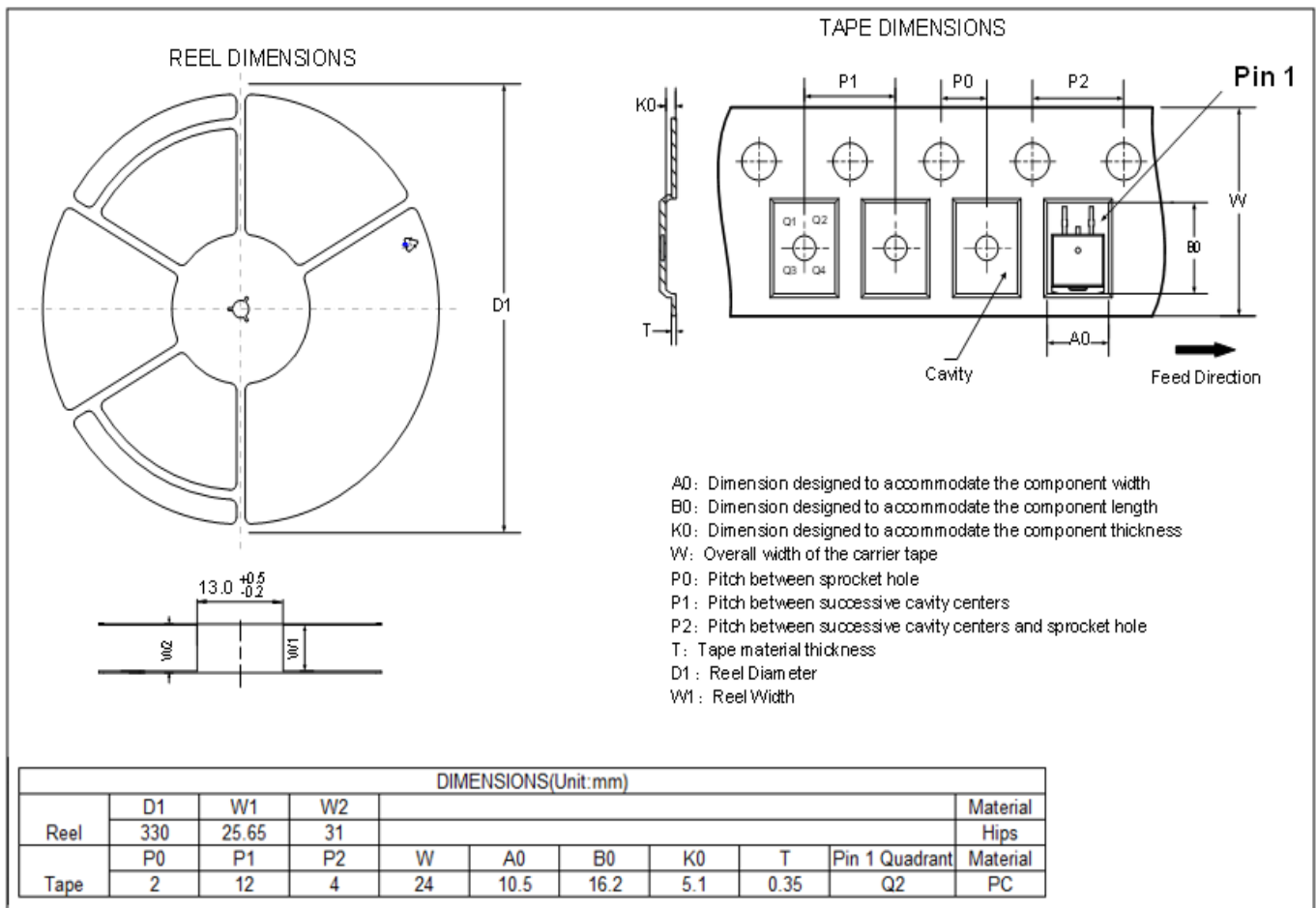

Revision History

Revision	Released	Remark
Rev.1.1	2024	

Disclaimer

The information given in this document describes the independent performance of the product, but similar performance is not guaranteed under other working conditions, and cannot be guaranteed when installed with other products or equipment. To achieve the required performance of the product in actual scenarios, the customer should conduct a complete application test to assess the functionality of the product.

Alkaidsemi assumes no responsibility for equipment failures result from using products at values that exceed the ratings, operating conditions, or other parameters listed in the product specifications.

The product described in this specification is not applicable for aerospace or other applications which requires high reliability. Customers using or selling these products for use in medical, life-saving, or life-sustaining applications do so at their own risk and agree to fully indemnify.

Due to product or technical improvements, the information described or contained herein may be changed without prior notice.