

## 650V 75A Insulated Gate Bipolar Transistor AKB65A075WBH

### Description:

Gen 3 IGBT with soft, fast recovery full current rated anti-parallel Emitter Controlled diode, providing ultra-low conduction loss. They are designed for applications such as UPS, inverters, etc.

### Features:

- Easy paralleling capability due to positive temperature coefficient in  $V_{CESAT}$
- Low EMI
- Low Gate Charge
- Very soft, fast recovery full current anti-parallel diode
- Maximum junction temperature  $T_{VJmax} = 175^{\circ}C$
- RoHS compliant
- Halogen-free
- Compliant by AEC-Q101

### Applications:

- Industrial UPS
- Charger
- Energy Storage
- Three-Phase Solar String Inverter

### Key Performance Parameters:

Parameter	Value	Unit
$V_{CE}$	650	V
$V_{CESAT}, T_{VJ} = 25^{\circ}C$	1.6	V
$I_C$	75	A

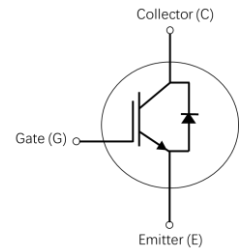
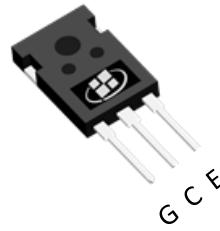

### Ordering Information:

Ordering Code	Package Type	Marking Code	Form	Packing
AKB65A075WBH	TO247-3L	B65A075WBH	Tube	360 per box

**Maximum Ratings** ( $T_{VJ} = 25^{\circ}\text{C}$  unless otherwise noted)

Symbol	Parameter	Value	Units
$V_{CE}$	Collector - Emitter Voltage	650	V
$I_C$	Collector Current - Continuous ( $T_C = 25^{\circ}\text{C}$ ) <sup>(Note 1)</sup>	90	A
	Collector Current - Continuous ( $T_C = 100^{\circ}\text{C}$ )	75	A
$I_{CM}$	Collector Current - Pulsed <sup>(Note 2)</sup>	300	A
$I_F$	Diode Forward Current, Limited by $T_{VJmax}$ ( $T_C = 25^{\circ}\text{C}$ )	90	A
	Diode Forward Current, Limited by $T_{VJmax}$ ( $T_C = 100^{\circ}\text{C}$ )	75	A
$I_{FM}$	Diode Pulsed Current - Pulsed <sup>(Note 2)</sup>	300	A
$V_{GE}$	Gate - Emitter Voltage	$\pm 20$	V
	Transient Gate - Emitter Voltage ( $t_p \leq 10\mu\text{s}$ , $D < 0.010$ )	$\pm 30$	
$P_D$	Power Dissipation ( $T_C = 25^{\circ}\text{C}$ )	333	W
	Power Dissipation ( $T_C = 100^{\circ}\text{C}$ )	166	W
$T_{VJ}$	Operating Junction Temperature Range	-40 to +175	$^{\circ}\text{C}$
$T_{STG}$	Storage Temperature Range	-55 to +150	$^{\circ}\text{C}$

**Thermal Characteristics**

Symbol	Parameter	Value	Units
$R_{\theta JC}$	IGBT Thermal Resistance, Junction - to - Case, Steady - State	0.45	$^{\circ}\text{C}/\text{W}$
$R_{\theta JC}$	Diode Thermal Resistance, Junction - to - Case, Steady - State	0.6	$^{\circ}\text{C}/\text{W}$
$R_{\theta JA}$	Thermal Resistance, Junction - to - Ambient Steady State	40	$^{\circ}\text{C}/\text{W}$

**Notes:**

1. The max collector current rating is package limited
2. Repetitive rating: pulse width limited by maximum junction temperature

**Electrical Characteristics** ( $T_{VJ} = 25^{\circ}\text{C}$  unless otherwise noted)

Symbol	Parameter	Test Conditions	Min	Typ	Max	Units
<b>Static Characteristics</b>						
$V_{(BR)CES}$	Collector-Emitter Breakdown Voltage	$V_{GE} = 0\text{ V}, I_C = 0.2\text{ mA}$	650			V
$V_{CESAT}$	Collector-Emitter Saturation Voltage	$V_{GE} = 15\text{ V}, I_C = 75\text{ A}$		1.60	2.10	V
		$V_{GE} = 15\text{ V}, I_C = 75\text{ A}, T_{VJ} = 125^{\circ}\text{C}$		1.86		
		$V_{GE} = 15\text{ V}, I_C = 75\text{ A}, T_{VJ} = 175^{\circ}\text{C}$		2.00		
$V_F$	Diode Forward Voltage	$V_{GE} = 0\text{ V}, I_F = 75\text{ A}$		1.55	1.90	V
		$V_{GE} = 0\text{ V}, I_F = 75\text{ A}, T_{VJ} = 125^{\circ}\text{C}$		1.45		
		$V_{GE} = 0\text{ V}, I_F = 75\text{ A}, T_{VJ} = 175^{\circ}\text{C}$		1.40		
$V_{GE(th)}$	Gate-Emitter Threshold Voltage	$V_{CE} = V_{GE}, I_C = 0.75\text{ mA}$	3.2	4.0	4.8	V
$I_{CES}$	Zero Gate Voltage Collector Current	$V_{CE} = 650\text{ V}, V_{GE} = 0\text{ V}$			75	$\mu\text{A}$
		$V_{CE} = 650\text{ V}, V_{GE} = 0\text{ V}, T_{VJ} = 175^{\circ}\text{C}$		2000		
$I_{GES}$	Gate-Emitter Leakage Current	$V_{GE} = \pm 20\text{ V}, V_{CE} = 0\text{ V}$			$\pm 100$	nA
$g_{fs}$	Transconductance	$V_{CE} = 20\text{ V}, I_C = 75\text{ A}$		86		S
<b>Dynamic Characteristics</b>						
$C_{ies}$	Input Capacitance	$V_{CE} = 25\text{ V}, V_{GE} = 0\text{ V},$ $F = 1\text{ MHz}$		2810		pF
$C_{oes}$	Output Capacitance			215		pF
$C_{res}$	Reverse Transfer Capacitance			23		pF
$Q_G$	Total Gate Charge	$V_{CC} = 520\text{ V}, I_C = 75\text{ A},$ $V_{GE} = 15\text{ V}$		104		nC
$Q_{GE}$	Gate-Emitter Charge			15		nC
$Q_{GC}$	Gate-Collector Charge			30		nC
$L_E$	Internal Emitter Inductance			13		nH
<b>Switching Characteristics, Inductive Load</b> ( $T_{VJ} = 25^{\circ}\text{C}$ )						
$t_{d(on)}$	Turn On Delay Time	$V_{CC} = 400\text{ V}$ $I_C = 75\text{ A}$ $V_{GE} = 15\text{ V}$ $R_{Gon} = 8\ \Omega$ $R_{Goff} = 8\ \Omega$		24		ns
$t_r$	Rise Time			27		ns
$t_{d(off)}$	Turn Off Delay Time			186		ns
$t_f$	Fall Time			32		ns
$E_{on}$	Turn On Energy			1.78		mJ
$E_{off}$	Turn Off Energy			0.92		mJ
$E_{ts}$	Total Switching Energy			2.70		mJ

$t_{d(on)}$	Turn On Delay Time	$V_{CC} = 400\text{ V}$ $I_C = 37.5\text{ A}$ $V_{GE} = 15\text{ V}$ $R_{G(on)} = 8\ \Omega$ $R_{G(off)} = 8\ \Omega$		34		ns
$t_r$	Rise Time			12		ns
$t_{d(off)}$	Turn Off Delay Time			235		ns
$t_f$	Fall Time			14		ns
$E_{on}$	Turn On Energy			0.79		mJ
$E_{off}$	Turn Off Energy			0.55		mJ
$E_{ts}$	Total Switching Energy			1.34		mJ

**Diode Characteristics (  $T_{VJ} = 25^\circ\text{C}$  )**

$t_{rr}$	Reverse Recovery Time	$V_R = 400\text{ V}, I_F = 75\text{ A},$ $di/dt = 1000\text{ A}/\mu\text{s}$		67		ns
$Q_{rr}$	Reverse Recovery Charge			1.0		$\mu\text{C}$
$I_{rrm}$	Peak Reverse Recovery Current			21		A
$dI_{rr}/dt$	Diode Peak Rate of Fall of Reverse Recovery Current			620		$\text{A}/\mu\text{s}$

$t_{rr}$	Reverse Recovery Time	$V_R = 400\text{ V}, I_F = 37.5\text{ A},$ $di/dt = 1000\text{ A}/\mu\text{s}$		38		ns
$Q_{rr}$	Reverse Recovery Charge			0.8		$\mu\text{C}$
$I_{rrm}$	Peak Reverse Recovery Current			25		A
$dI_{rr}/dt$	Diode Peak Rate of Fall of Reverse Recovery Current			1000		$\text{A}/\mu\text{s}$

**Switching Characteristics, Inductive Load (  $T_{VJ} = 150^\circ\text{C}$  )**

$t_{d(on)}$	Turn On Delay Time	$V_{CC} = 400\text{ V}$ $I_C = 75\text{ A}$ $V_{GE} = 15\text{ V}$ $R_{G(on)} = 8\ \Omega$ $R_{G(off)} = 8\ \Omega$		22		ns
$t_r$	Rise Time			25		ns
$t_{d(off)}$	Turn Off Delay Time			223		ns
$t_f$	Fall Time			35		ns
$E_{on}$	Turn On Energy			2.90		mJ
$E_{off}$	Turn Off Energy			1.05		mJ
$E_{ts}$	Total Switching Energy			3.95		mJ

$t_{d(on)}$	Turn On Delay Time	$V_{CC} = 400\text{ V}$ $I_C = 37.5\text{ A}$ $V_{GE} = 15\text{ V}$ $R_{G(on)} = 8\ \Omega$ $R_{G(off)} = 8\ \Omega$		31		ns
$t_r$	Rise Time			11		ns
$t_{d(off)}$	Turn Off Delay Time			310		ns
$t_f$	Fall Time			32		ns
$E_{on}$	Turn On Energy			1.87		mJ
$E_{off}$	Turn Off Energy			0.50		mJ
$E_{ts}$	Total Switching Energy			2.37		mJ

**Diode Characteristics** ( $T_{VJ} = 150^\circ\text{C}$ )

$T_{RR}$	Reverse Recovery Time	$V_R = 400\text{ V}, I_F = 75\text{ A},$ $di/dt = 1000\text{ A}/\mu\text{s}$		110		ns
$Q_{RR}$	Reverse Recovery Charge			3.1		$\mu\text{C}$
$I_{RRM}$	Peak Reverse Recovery Current			39		A
$d_{irr}/dt$	Diode Peak Rate of Fall of Reverse Recovery Current			1750		$\text{A}/\mu\text{s}$

$T_{RR}$	Reverse Recovery Time	$V_R = 400\text{ V}, I_F = 37.5\text{ A},$ $di/dt = 1000\text{ A}/\mu\text{s}$		94		ns
$Q_{RR}$	Reverse Recovery Charge			2.8		$\mu\text{C}$
$I_{RRM}$	Peak Reverse Recovery Current			46		A
$d_{irr}/dt$	Diode Peak Rate of Fall of Reverse Recovery Current			1080		$\text{A}/\mu\text{s}$

# Electrical Characteristics Diagrams

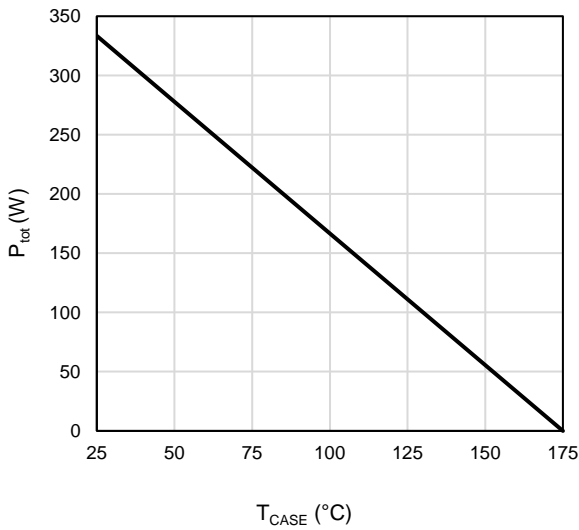

Figure 1: Power De-rating

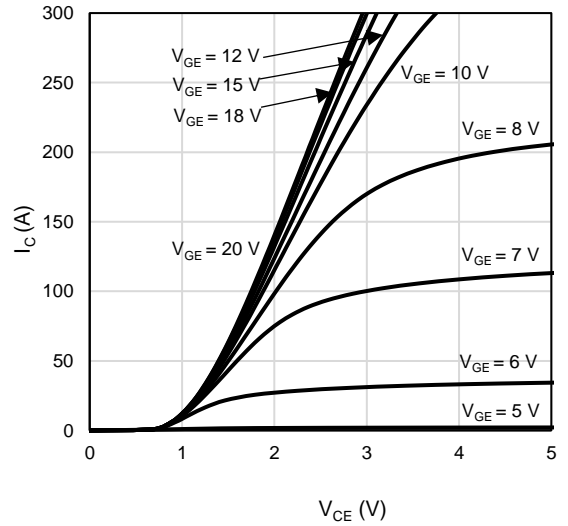

Figure 2: Typical Output Characteristics ( $T_{VJ} = 25^{\circ}C$ )

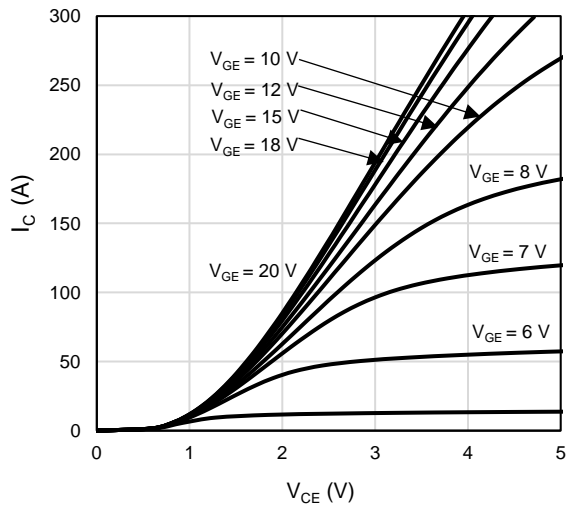

Figure 3: Typical Output Characteristics ( $T_{VJ} = 150^{\circ}C$ )

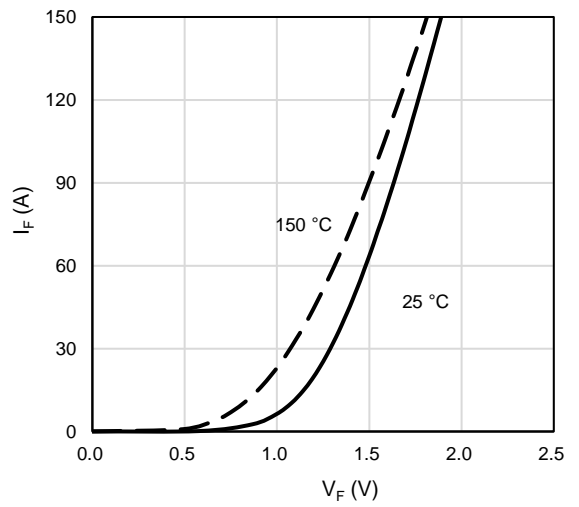

Figure 4: Diode Forward Current Characteristics

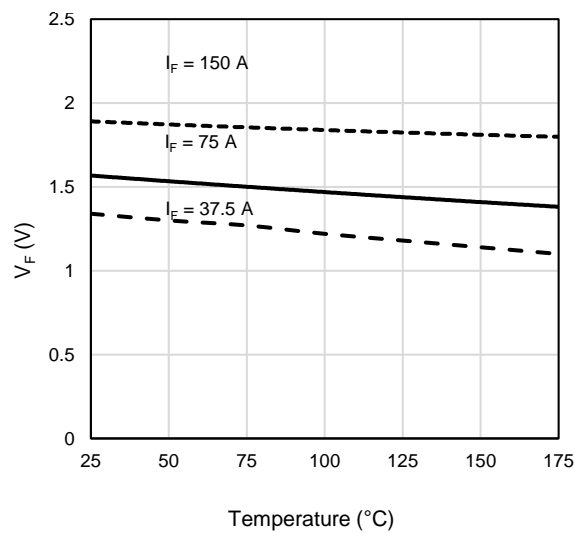

Figure 5: Diode Forward Voltage vs. Junction Temperature

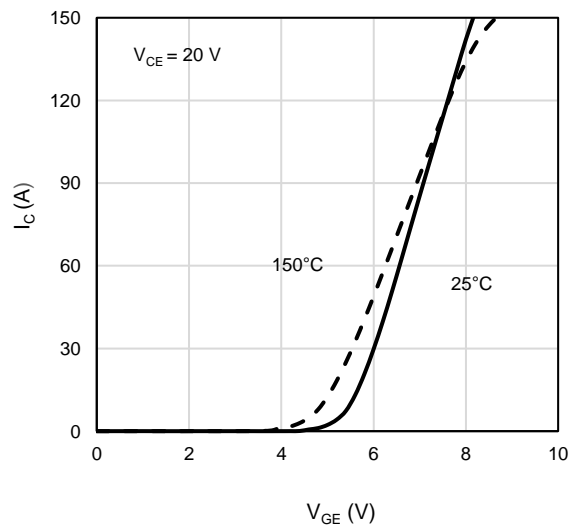

Figure 6: Transfer Characteristics

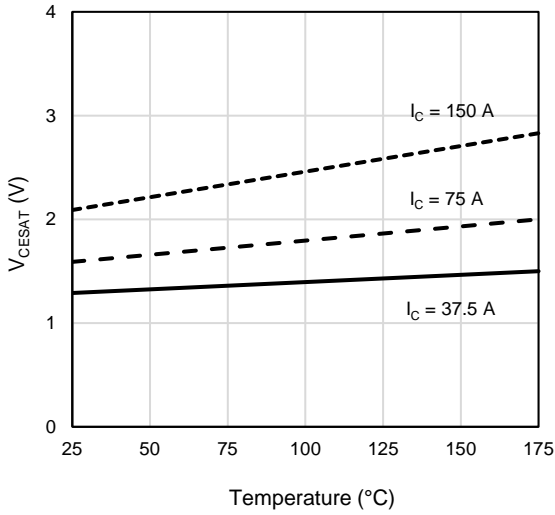

Figure 7: Collect-emitter saturation voltage vs. Junction Temperature

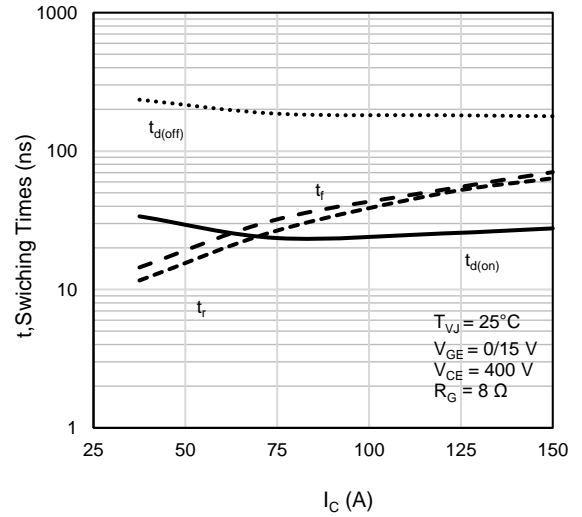

Figure 8: Switching Times vs. Collector Current

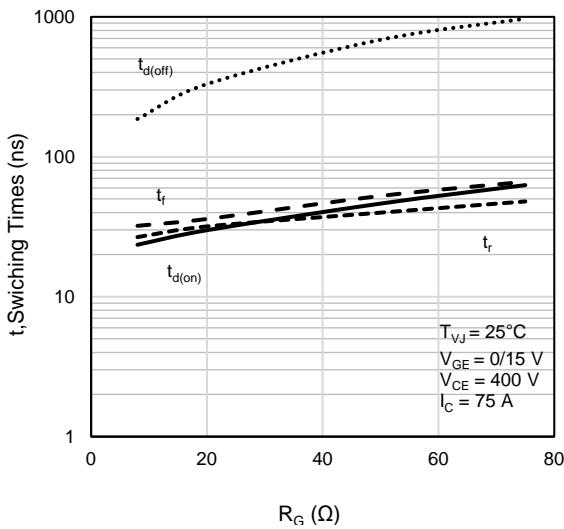

Figure 9: Switching Times vs. Gate Resistor

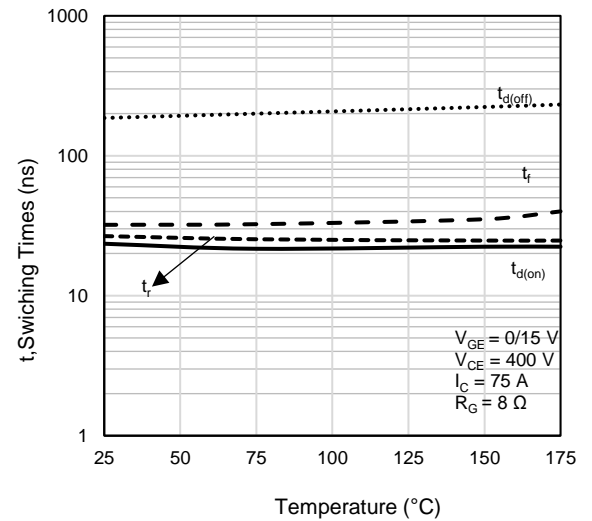

Figure 10: Switching Times vs. Junction Temperature

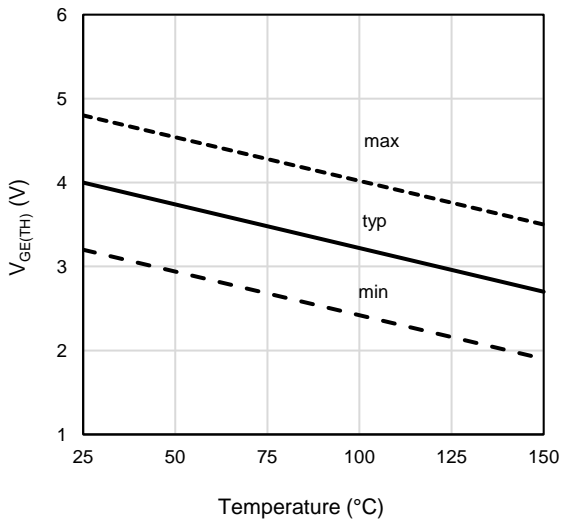

Figure 11: Threshold voltage vs. Junction Temperature

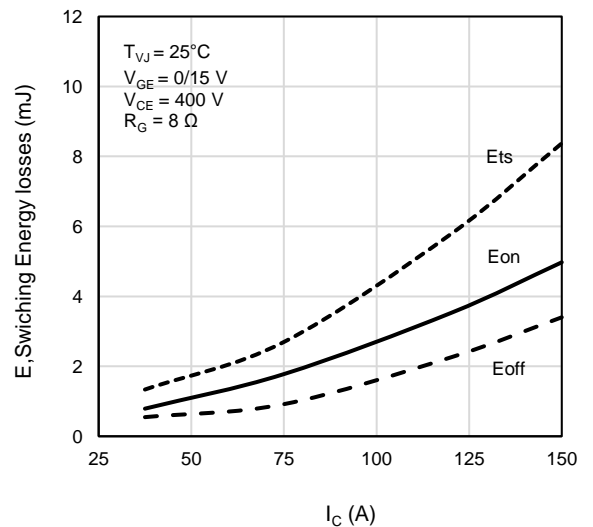

Figure 12: Switching Energy losses vs. Collector Current

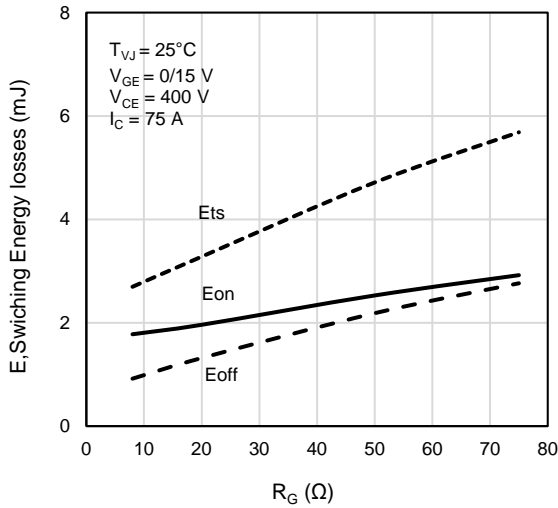

Figure 13: Switching Energy losses vs. Gate Resistor

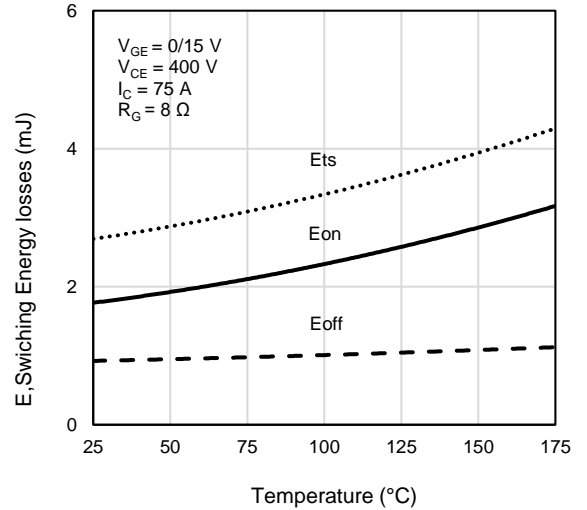

Figure 14: Switching Energy losses vs. Junction Temperature

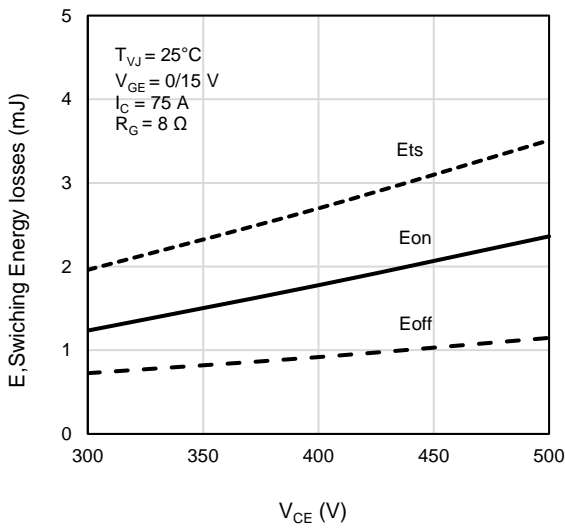

Figure 15: Switching Energy losses vs. Collector Emitter Voltage

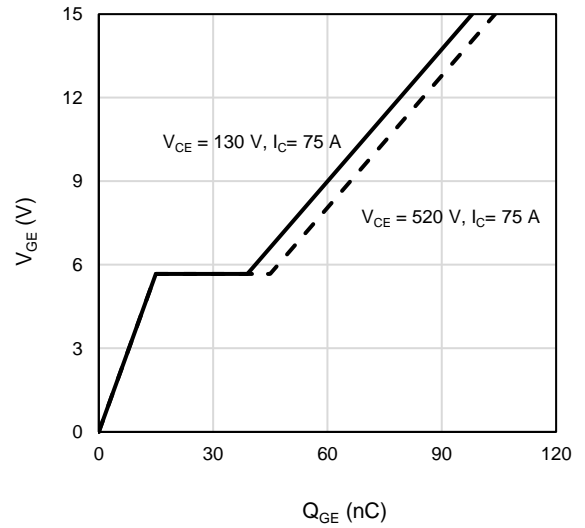

Figure 16: Gate-Charge Characteristics

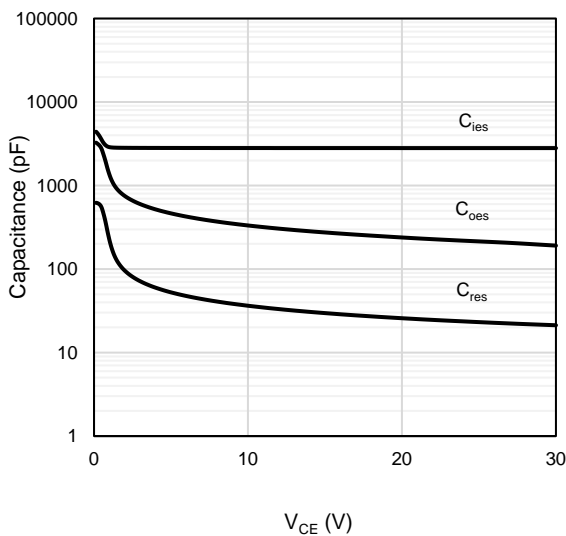

Figure 17: Capacitance Characteristics

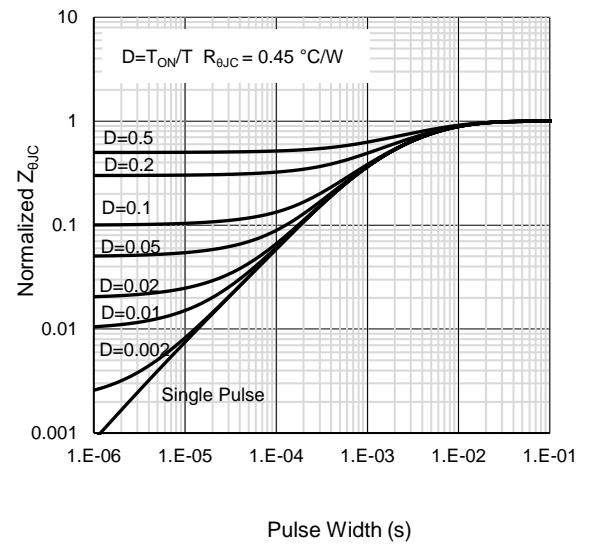

Figure 18: Normalized Maximum IGBT Transient Thermal Impedance



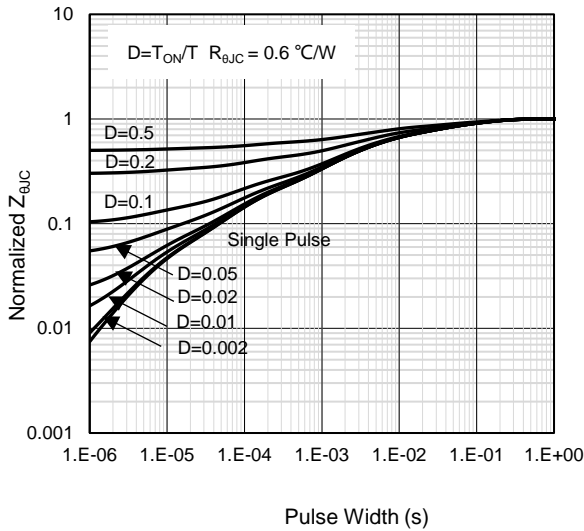

Figure 19: Normalized Maximum Diode Transient Thermal Impedance

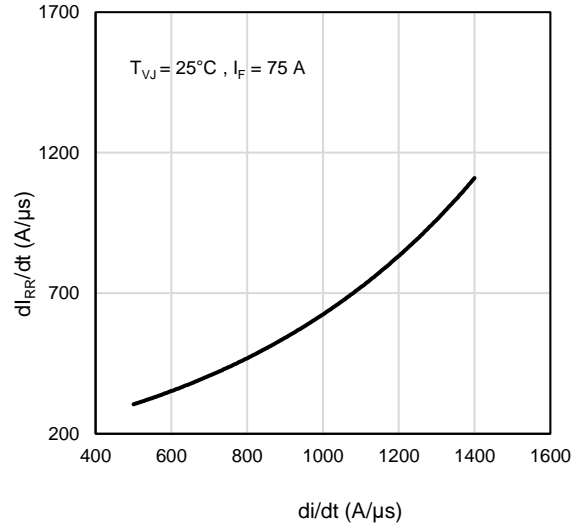

Figure 20: Diode Peak Rate of Fall of Reverse Recovery Current vs. Diode Current Slope

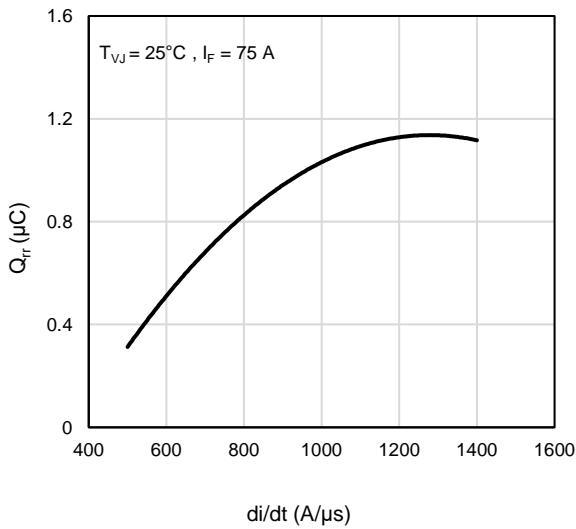

Figure 21: Reverse Recovery Charge vs. Diode Current Slope

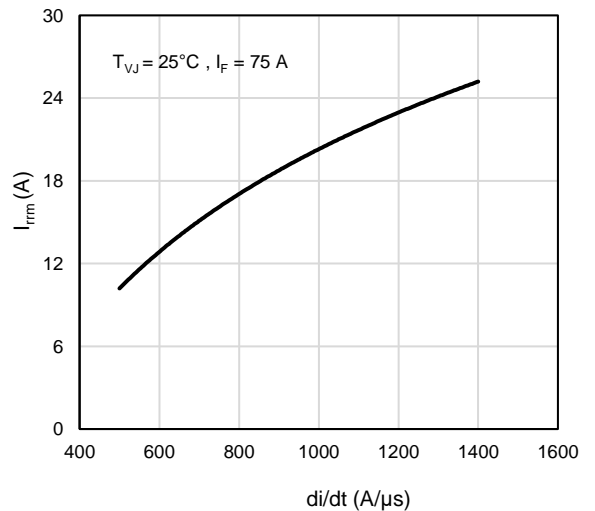

Figure 22: Reverse Recovery Current vs. Diode Current Slope

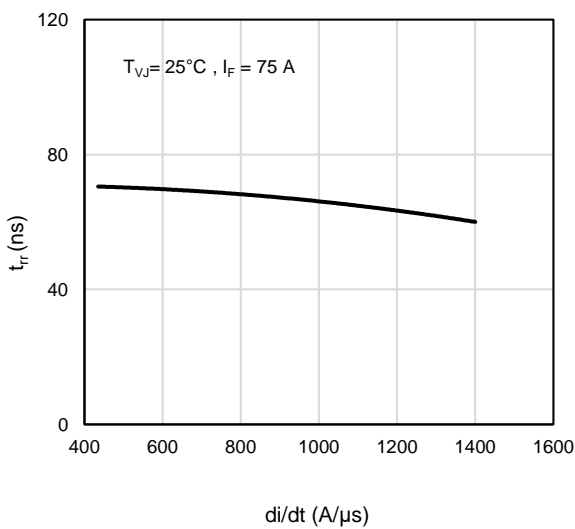
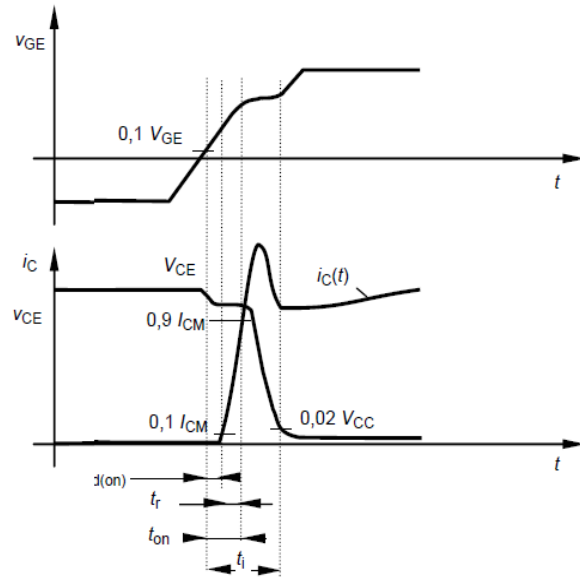
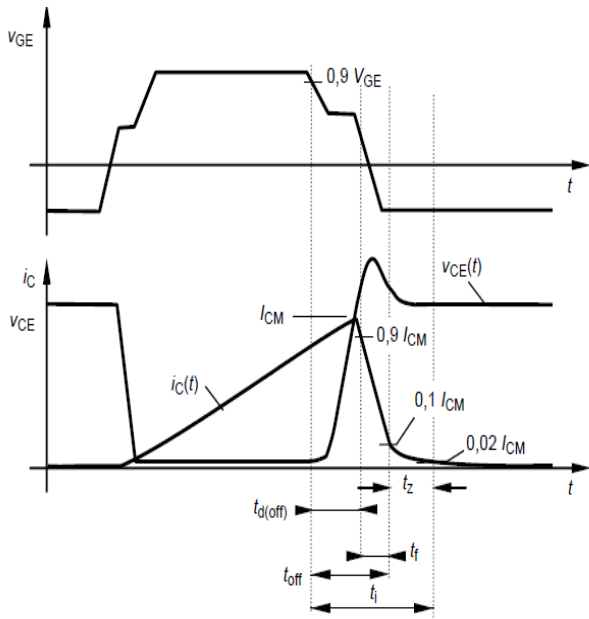

Figure 23: Reverse Recovery Time vs. Diode Current Slope

# Test Circuit and Waveform

## Switching Test Circuit & Waveforms



## Diode Recovery Test Circuit & Waveforms

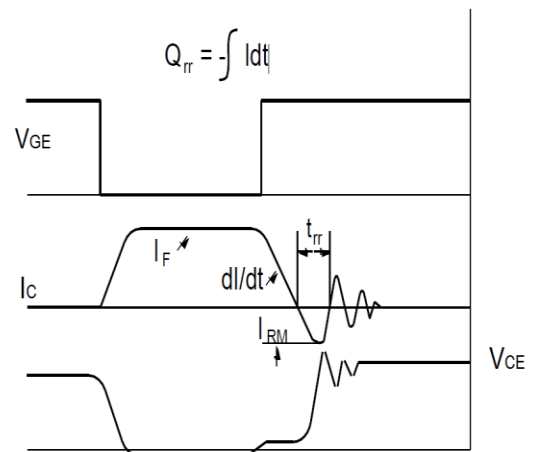
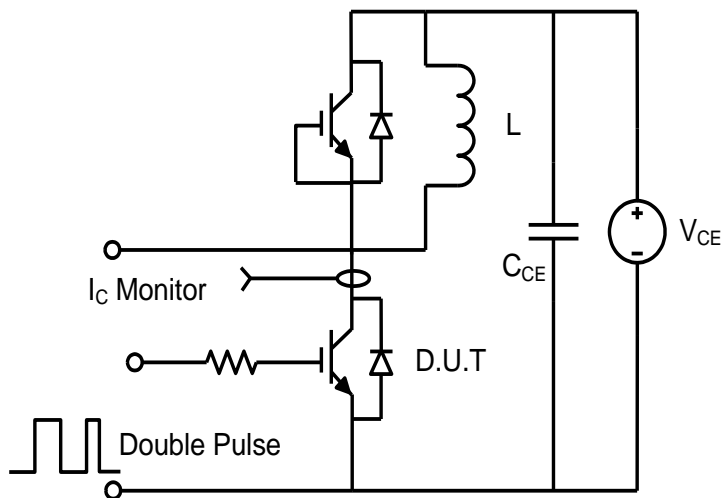

# Package Outlines

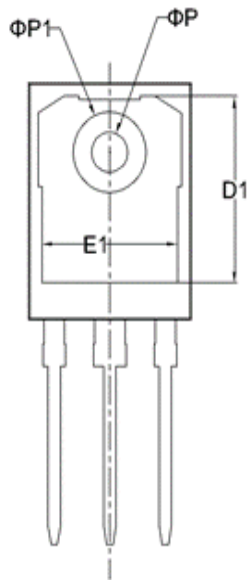
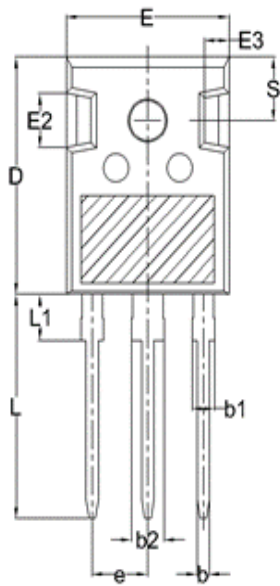

SYMBOL	MIN	NOM	MAX
A	4.80	5.00	5.20
A1	2.21	2.41	2.59
A2	1.85	2.00	2.15
b	1.11	1.21	1.36
b1	1.91	2.01	2.21
b2	2.91	3.01	3.21
c	0.51	0.61	0.75
D	20.80	21.00	21.30
D1	16.25	16.55	16.85
E	15.50	15.80	16.10
E1	13.00	13.30	13.60
E2	4.80	5.00	5.20
E3	2.30	2.50	2.70
e	5.44 BSC		
L	19.62	19.92	20.22
L1	-	-	4.30
$\Phi P$	3.40	3.60	3.80
$\Phi P1$	-	-	7.30
S	6.15 BSC		

## Marking Information



B65A075WBH

XXXXXXXX

Note:

B65A075WBH = Product Name Code

XXXXXXXX = Date code

Contact ALKAIDSEMI sales for detail information

---

## Revision History

Revision	Released	Remark
Rev.1.0	2024	Initial Release

## Disclaimer

The information given in this document describes the independent performance of the product, but similar performance is not guaranteed under other working conditions, and cannot be guaranteed when installed with other products or equipment. To achieve the required performance of the product in actual scenarios, the customer should conduct a complete application test to assess the functionality of the product.

Alkaidsemi assumes no responsibility for equipment failures result from using products at values that exceed the ratings, operating conditions, or other parameters listed in the product specifications.

The product described in this specification is not applicable for aerospace or other applications which requires high reliability. Customers using or selling these products for use in medical, life-saving, or life-sustaining applications do so at their own risk and agree to fully indemnify.

Due to product or technical improvements, the information described or contained herein may be changed without prior notice.